

GE
Sensing & Inspection Technologies



DigitalFlow™ GC868

Panametrics Gas Clamp-On Ultrasonic Flowmeter

Programming Manual (2-Channel)



GE
Sensing & Inspection Technologies

DigitalFlow™ GC868 *Panometrics Gas Clamp-On Ultrasonic Flowmeter*



Programming Manual (2-Channel)

910-226P2F1

April 2008

The *DigitalFlow* GC868 is a GE Panometrics product. GE Panometrics has joined other GE high-technology businesses under a new name—GE Sensing & Inspection Technologies.



Warranty

Each instrument manufactured by GE Sensing, Inc. is warranted to be free from defects in material and workmanship. Liability under this warranty is limited to restoring the instrument to normal operation or replacing the instrument, at the sole discretion of GE. Fuses and batteries are specifically excluded from any liability. This warranty is effective from the date of delivery to the original purchaser. If GE determines that the equipment was defective, the warranty period is:

- one year for general electronic failures of the instrument
- one year for mechanical failures of the sensor

If GE determines that the equipment was damaged by misuse, improper installation, the use of unauthorized replacement parts, or operating conditions outside the guidelines specified by GE, the repairs are not covered under this warranty.

The warranties set forth herein are exclusive and are in lieu of all other warranties whether statutory, express or implied (including warranties of merchantability and fitness for a particular purpose, and warranties arising from course of dealing or usage or trade).

Return Policy

If a GE Sensing, Inc. instrument malfunctions within the warranty period, the following procedure must be completed:

1. Notify GE, giving full details of the problem, and provide the model number and serial number of the instrument. If the nature of the problem indicates the need for factory service, GE will issue a RETURN AUTHORIZATION number (RA), and shipping instructions for the return of the instrument to a service center will be provided.
2. If GE instructs you to send your instrument to a service center, it must be shipped prepaid to the authorized repair station indicated in the shipping instructions.
3. Upon receipt, GE will evaluate the instrument to determine the cause of the malfunction.

Then, one of the following courses of action will then be taken:

- If the damage is covered under the terms of the warranty, the instrument will be repaired at no cost to the owner and returned.
- If GE determines that the damage is not covered under the terms of the warranty, or if the warranty has expired, an estimate for the cost of the repairs at standard rates will be provided. Upon receipt of the owner's approval to proceed, the instrument will be repaired and returned.

Table of Contents

Chapter 1: Programming Site Data

Introduction	1-1
Using the Keypad	1-2
Obtaining On-line Help	1-6
Using the Console Control Keys	1-7
Audio Alarm Volume	1-7
Stopwatch Totalizer	1-7
Display Brightness.....	1-7
Display Contrast.....	1-7
Entering Programming Mode	1-8
Entering Programming Mode	1-8
Entering Channel Data	1-9
Activating a Channel	1-9
Entering System Data for a Channel.....	1-10
Entering Pipe Data	1-12
Setting Up Inputs/Outputs	1-16
Entering Setup Data	1-19
Entering Global Data	1-33
Setting the Clock	1-34
Entering Global System Data.....	1-35
Setting Up Global Inputs/Outputs	1-37
Setting Up Communications	1-45
MODBUS Register Map	1-47
Activating Security	1-50
Saving Site Files.....	1-52
Recalling Site Files.....	1-53

Chapter 2: Displaying Data

Introduction	2-1
The BIG Submenu	2-2
The DUAL Submenu	2-3
The GRAPH Submenu.....	2-4
Setting Up the GRAPH Format.....	2-4
Using the GRAPH Format	2-5
The LOG Submenu	2-7
Entering the LOG Submenu	2-7
Numeric Format.....	2-8
Graphical Format.....	2-9
Displaying the Transducer Signal	2-11
Setting the LCD Backlight.....	2-14
Activating Sleep Mode.....	2-15

Table of Contents (cont.)

Chapter 3: Logging Data

Introduction	3-1
Creating a Standard Log	3-2
Log Type	3-3
STARTTIME Prompt	3-3
START DATE Prompt	3-4
END TIME Prompt	3-4
END DATE Prompt	3-5
DURATION Prompt	3-5
LOG TIME Prompt	3-5
TIME INCREMENT Prompt	3-6
Checking the Memory	3-7
Stopping a Log	3-8
Creating an ERROR Log	3-9
Log Type	3-10
STARTTIME Prompt	3-10
START DATE Prompt	3-11

Chapter 4: Printing Data

Introduction	4-1
Printing Live Data	4-2
Numeric Format	4-2
Graphical Format	4-3
Printing Logs	4-5
Numeric Format	4-5
Graphical Format	4-6
Printing a Site File	4-7
Stop Printing	4-8
Setting Up a Printer	4-9
Printing Signal Array Data	4-10
Printing RTD Data	4-12

Chapter 5: Clearing Data

Introduction	5-1
Reset Totals	5-2
Deleting Site Files	5-3
Deleting Log Files	5-4

Table of Contents (cont.)

Chapter 6: Serial Communications

Introduction	6-1
Wiring the RS232 Interface	6-1
Checking the GC868 Baud Rate	6-2
Setting Up the Terminal Software	6-2
Windows 9X/NT Systems	6-3
The Optional RS485 Serial Interface	6-4
Interface Converter Mounting	6-4
Point-To-Point Wiring	6-5
Multi-Point Wiring	6-6
Setting Up an Ethernet Connection	6-9
Setting Up a MODBUS/TCP Connection	6-10

Appendix A: Menu Maps

Appendix B: Data Records

Option Cards Installed	B-1
Initial Setup Data	B-2

Appendix C: Programming with PanaView

Introduction	C-1
Wiring the RS232 Interface	C-1
Setting Up the Communications Port	C-2
Setting up Ethernet Communications	C-4
Adding the GC868	C-5
Editing Meter Properties	C-7
Setting the Meter Clock	C-9
Reading Transducer Signals	C-10
Plotting Transducer Signals	C-10
Saving Transducer Signals	C-11
Clearing Totalizers	C-11
Handling Site Files	C-12
Changing Meter Settings	C-15

Appendix D: Foundation Fieldbus Communications

Optional Measurements	D-1
Configuration Utility Setup	D-2
Selecting the Desired Measurements	D-2
Selecting Units for AI Blocks	D-4
Resetting Instrument Totalizers	D-5
Function Block Application	D-6

Chapter 1

Programming Site Data

- Introduction..... 1-1
- Using the Keypad..... 1-2
- Obtaining On-line Help..... 1-6
- Using the Console Control Keys..... 1-7
- Entering Programming Mode..... 1-8
- Entering Channel Data..... 1-9
- Entering Global Data..... 1-33
- Saving Site Files..... 1-52
- Recalling Site Files..... 1-53

Introduction

The 2-Channel Model GC868 flowmeter cannot provide accurate flow rate measurements for either channel until the instrument has been properly installed, the channel has been activated, and the basic system and pipe parameters have been programmed into the meter. See the *Startup Guide* for detailed instructions on performing these tasks. After completing the installation, proceed with this chapter to program the Model GC868's advanced features.

Four submenus within the *User Program* provide access to the various programmable features of the Model GC868. Step-by-step programming instructions for each submenu are presented in this chapter. Refer to the appropriate section for a discussion of the following *User Program* submenus:

- CH1/CH2 - use this submenu to activate a channel and to enter the basic setup parameters for that channel.
- GLOBL - use this submenu to enter global meter parameters (i.e., clock, system, input/output, communications and security), which apply to both channels.
- SAVE - use this submenu to store both channel and global data in the meter's memory, as a site file.
- RECLL - use this submenu to recall and activate a stored site file.

Note: *It is not required that both channels of a 2-Channel Model GC868 be installed. The second channel connector may simply be left vacant for future expansion.*

As an aid in following the programming instructions, a complete menu map of the *User Program* is included in Appendix A, *Menu Maps*.

Note: *In the menu map drawings, plain text represents prompt area messages and boxed text represents option bar choices. Fx represents a function key to select an option bar choice.*

Using the Keypad

The Model GC868 keypad contains 39 keys, which are labeled with their primary (unshifted) functions. In addition, pressing the red [SHIFT] key will access the secondary functions assigned to most of the keys.

The complete keypad is illustrated in Figure 1-1 below and a detailed description of both the unshifted and shifted functions for each of the 39 keys is listed in Table 1-1 on page 1-3.

Note: *Only the [SHIFT] key and the eight [F_x] keys have no shifted function.*

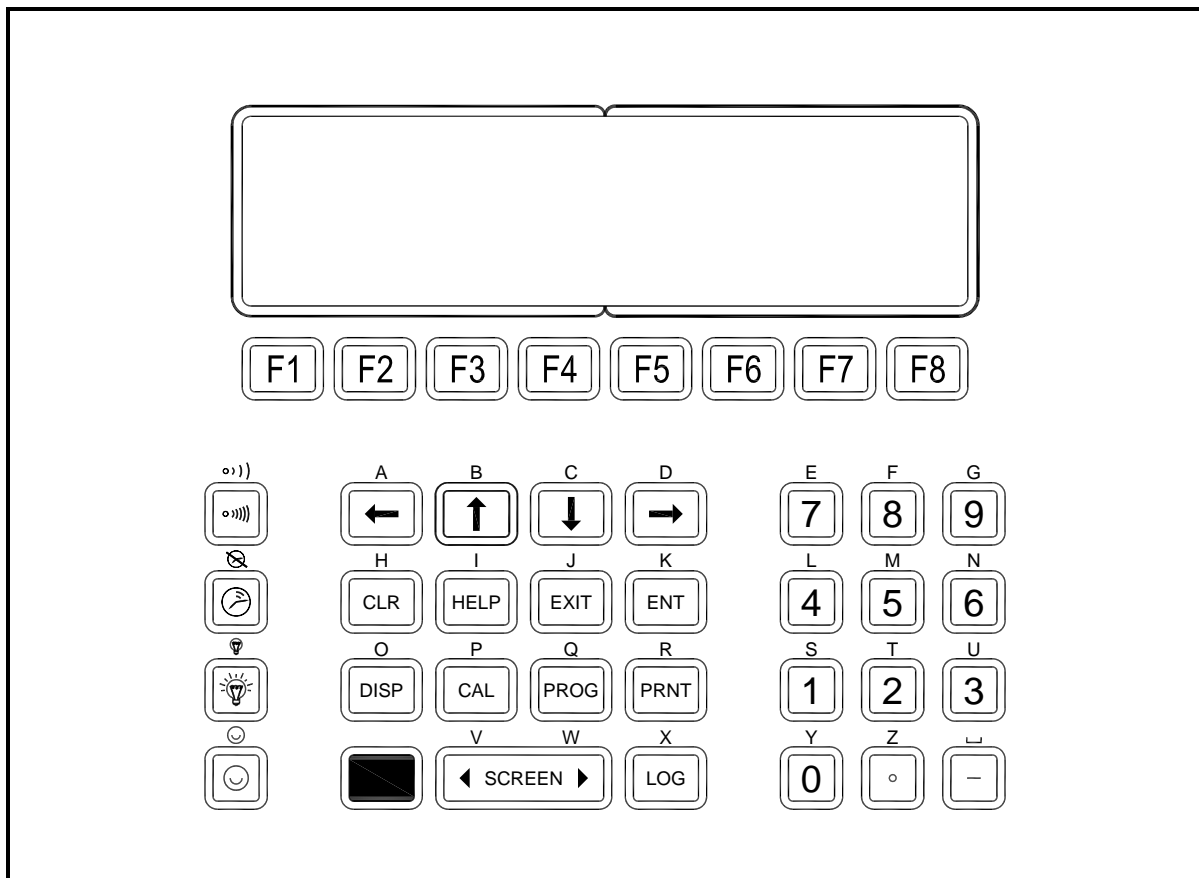

Figure 1-1: The Model GC868 Keypad

Note: *Although the keypad is essentially the same, the front panel layout of meters supplied in one of the optional enclosures is different. See Appendix C, Optional Enclosures, of the Startup Guide for a picture of the applicable front panel.*

Table 1-1: Model GC868 Key Functions















Key	Unshifted Function	Shifted Function
	Software Function Keys - press to select the functions displayed directly above them in the option bar. These keys apply only to the left pane of the display screen.	None
		
		
		
	Software Function Keys - press to select the functions displayed directly above them in the option bar. These keys apply only to the right pane of the display screen.	None
		
		
		
	Shift Key - use this red key to access the shifted function of the other keys. One press shifts the next keystroke only. Two presses locks the keypad in shifted mode. A third press releases the shift function.	None
	Arrow Keys - in measurement mode, use to scroll through function choices on the option bar. In programming mode, use to scroll through menu choices. The [←] also acts as a backspace key in programming mode.	Use to enter the letters A, B, C and D, respectively.
		
		
		
	Program Key - press to enter the <i>User Program</i> . See page 1-8 for details.	Use to enter the letter Q.

Table 1-1: Model GC868 Key Functions (Continued)

























Key	Unshifted Function	Shifted Function
	Display Key - use to display data in a variety of numeric and graphic formatting options. See page 2-2 for details.	Use to enter the letter O.
	Log Key - use to set up logs. See page 3-1 for details.	Use to enter the letter X.
	Print Key - use to print live measurements, log files and signal arrays. See page 4-2 for details.	Use to enter the letter R.
	Clear Key - use to reset totals and to delete site and log files from the Model GC868 memory. See page 5-1 for details.	Use to enter the letter H.
	Calibration Key - use to calibrate the analog inputs and outputs and to test the alarm relays and the totalizer/frequency outputs. See Chapter 1, <i>Calibration</i> , of the <i>Service Manual</i> for details.	Use to enter the letter P.
	Exit Key - use to move up one level in the user program or to exit the user program. See page 1-10 for details.	Use to enter the letter J.
	Enter Key - use to confirm the most recent input information.	Use to enter the letter K.
	Help Key - use to access the Model GC868's context-sensitive on-line help system. See the next section for details.	Use to enter the letter I.
	Screen Key - press the left side to select the left display pane or press the right side to select the right display pane.	Press the left side to enter the letter V or press the right side to enter the letter W.
	Decimal Point Key - press to enter a decimal point during numeric entry.	Use to enter the letter Z.
	Minus Key - use to enter a minus sign or a dash.	Use to enter a space character.
	Zero Key - use to enter the number 0.	Use to enter the letter Y.
	One Key - use to enter the number 1.	Use to enter the letter S.
	Two Key - use to enter the number 2.	Use to enter the letter T.

Table 1-1: Model GC868 Key Functions (Continued)

Key	Unshifted Function	Shifted Function
	Three Key - use to enter the number 3.	Use to enter the letter U.
	Four Key - use to enter the number 4.	Use to enter the letter L.
	Five Key - use to enter the number 5.	Use to enter the letter M.
	Six Key - use to enter the number 6.	Use to enter the letter N.
	Seven Key - use to enter the number 7.	Use to enter the letter E.
	Eight Key - use to enter the number 8.	Use to enter the letter F.
	Nine Key - use to enter the number 9.	Use to enter the letter G.
	Audio Level Key - press to increase the audio alarm volume.	Press to decrease the audio alarm volume.
	Stopwatch Timer Key - press to turn the stopwatch timer on.	Press to turn the stopwatch timer off.
	Backlight Key - press to turn the display backlight on or to increase its brightness.	Press to turn the display backlight off or to decrease its brightness.
	Contrast Key - press to increase the contrast of the display screen.	Press to decrease the contrast of the display screen.

Obtaining On-line Help

A context-sensitive, on-line help system is programmed into every Model GC868 flowmeter. On-line help, which displays additional information related to the current task, may be accessed at any time by pressing the [HELP] key on the keypad. The help information will be shown on the currently selected pane of the display screen, as shown in Figure 1-2 below.

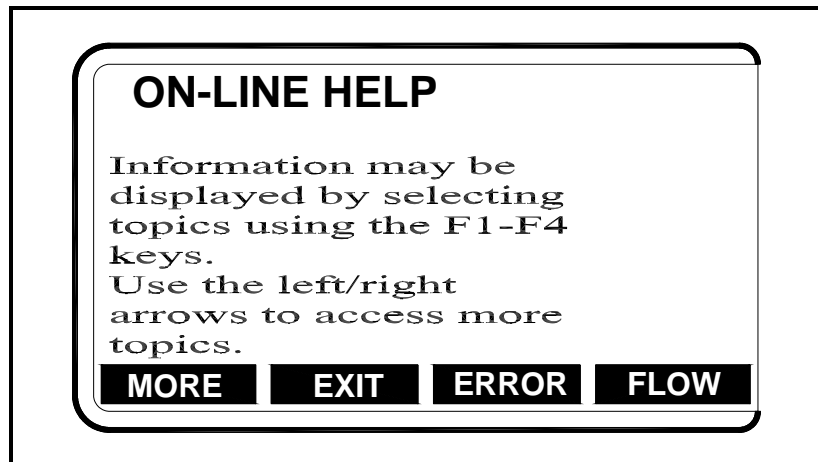

Figure 1-2: Typical On-Line Help Screen

After entering the on-line help system, the following functions are available on the option bar of the selected display pane:

- **MORE:** Press [F1] (or [F5]) to access this function, and the next screen of text is displayed in the prompt area.
- **EXIT:** Press [F2] (or [F6]) to access this function, and the Model GC868 returns to measurement mode.
- **ERROR:** Press [F3] (or [F7]) to access this function, and the various Model GC868 error codes are displayed. Use the [F1]-[F4] (or [F5]-[F8]) function keys, in conjunction with the [←] and [→] keys, to obtain additional information on the desired error code or to exit the help system.

Note: See the Service Manual for a complete listing of all error codes and messages.

- **FLOW:** Press [F4] (or [F8]) to access this function, and the various flow measurement parameters are displayed. Use the [F1]-[F4] (or [F5]-[F8]) function keys, in conjunction with the [←] and [→] keys, to obtain additional information on the desired measurement parameter or to exit the help system.

Using the Console Control Keys

The Model GC868 has four console control keys, which are located on the left side of the keypad. Use these keys, which are described and pictured in Table 1-1 on page 1-3, in accordance with the following instructions:

Audio Alarm Volume

Use the top console control key to adjust the audio alarm volume.



Discrete presses will incrementally increase the volume of the audio alarm. Hold the key down for continuous increase. Use the key in shifted mode to decrease the volume of the audio alarm.

Stopwatch Totalizer

Use the second console control key for the stopwatch totalizer.



Press the key once to start the stopwatch totalizer. Press the key once, in shifted mode, to stop the stopwatch totalizer.

Note: *Instructions on properly setting up the stopwatch totalizer are given later in this chapter. Also, the Service Manual provides information on the error response of the stopwatch totalizer.*

Display Brightness

Use the third console control key to adjust the display backlight.



Discrete presses of this key will increase the backlight brightness through settings of Off, Mid and Full. Discrete presses of this key in shifted mode, will decrease the backlight brightness through settings of Full, Mid and Off.

Note: *The display backlight has an automatic time-off feature. See page 2-14 for setup instructions.*

Display Contrast

Use the bottom console key to adjust the display contrast.



Discrete presses will incrementally increase the display contrast. Hold the key down for continuous increase. Use the same key, in shifted mode, to decrease display contrast.

Entering Programming Mode

Use the keypad, as described in Chapter 3, *Operation*, of the *Startup Guide* to navigate through the *User Program*. The menu map may be followed in sequence, or the [↑] and [↓] keys may be used to scroll through the prompt screens. The [←] key may be used to delete the last alphanumeric character that was entered from the keypad.

The following discussion assumes that the left screen pane is active. If the right screen pane is active, only the function key designations change. That is, replace [F1]-[F4] with [F5]-[F8]. Also, Channel 1 is used in all examples, but the instructions apply equally to Channel 2.

Note: *Be sure to record all the programming data entered in this chapter in Appendix B, Data Records.*

Programming of the ACTIV, SYSTM and PIPE submenus is necessary for operation of the Model GC868. Failure to accurately enter all of the required information will result in unreliable flow rate data. Therefore, be sure to complete at least the sections of this chapter pertaining to those three submenus.

Note: *Because it is so essential, instructions for programming the ACTIV, SYSTM and PIPE submenus are also included in the Startup Guide. If that programming has already been completed, skip the corresponding sections of this chapter.*

Except for the three submenus noted above, it is not necessary to program the Model GC868 flowmeter in any particular order. Therefore, the sections of this chapter need not be completed in sequence. Proceed immediately to any section of interest.

Entering Programming Mode

To access the *User Program*, press the [PROG] key on the keypad. The standard measurement mode screen will be replaced by the following initial programming mode screen:

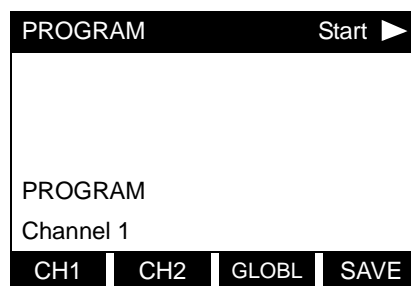

Press the [←] and [→] keys and one of the function keys [F1]-[F4] to select the desired submenu. From this screen, press [EXIT] to return to measurement mode.

Note: *If the security feature is active, enter the password and press the [ENT] key to enter the User Program. See the SECUR submenu section of this chapter on page 1-50 for more information on the security feature.*

Entering Channel Data

After selecting [F1]=CH1 (or [F2]=CH2) at the initial programming screen, the following screen appears:

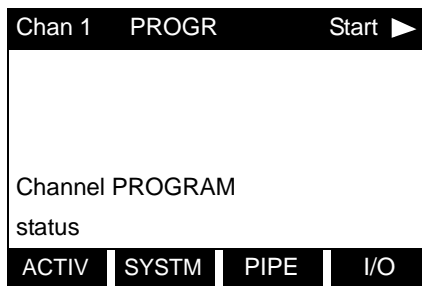

Press the [←] and [→] keys and a function key [F1]-[F4] to select the desired submenu. From this screen, press [EXIT] to return to the initial *User Program* screen shown on page 1-8.

Activating a Channel

Based on the selection made above, proceed to the appropriate section of this chapter for instructions.

The ACTIV submenu activates a channel and selects the desired measurement method.

1. To enter the Channel PROGRAM menu, press [F1] or [F2] (depending on the desired channel) at the User PROGRAM prompt.
2. Enter the ACTIV submenu by pressing [F1] at the Channel PROGRAM prompt.
3. Press [F1] (OFF) to deactivate the channel and return to the Channel PROGRAM prompt, or press [F2] to activate the channel in BURST mode.
4. Press [F1] to select *Skam* mode, [F2] to select *Skam/Measure Integrate* mode, [F3] to select *Skam/Measure Count* mode, or [F4] to select *Skam/Correlation* mode. The meter will exit the ACTIV submenu and return to the channel menu screen.
 - a. If you select *Skam* or *Skam/Measure Count* modes, the GC868 asks if you will *Use 703-1273 DSP?* (the digital signal processing board). Press [F2] to apply the board, or [F1] to apply the onboard signal processing. (The factory recommends using the DSP for improved response time.)

The Model GC868 flowmeter can take measurements in four different ways

- **Skam** is a low resolution technique for locating the acoustic signal and for high velocity measurements. It is more robust in a noisy environment than the *Measure* technique. A variation, the *Skam/Correlation* mode, is used primarily for liquid detection applications.
- **Measure** is a more precise technique best used for low velocity measurements. You can choose from *Skam/Measure Count* (the default technique) or *Skam/Measure Integrate* (the traditional *Skam/Measure* mode).

IMPORTANT: *Consult with the factory before selecting the Skam/Correlation or Skam/Measure Integrate modes.*

Activating a Channel (cont.)

If *Skán* is selected at the next prompt, the instrument uses this technique exclusively. However, if one of the *S/M* modes is selected, the meter uses *Skán* to find the acoustic signal and then tries to use the *Measure* technique for a more precise measurement.

Note: *To change the Skán and Measure parameters, see the SIGNAL and ADVAN submenu sections of this chapter.*

Procedure Options

After completing the above steps, the meter returns to the Channel PROGRAM prompt. Continue as follows:

- To continue programming the meter, refer to the menu maps in Appendix A and navigate to the desired menu. Then, proceed to the appropriate section of this manual for instructions.
- To leave the User Program and retain the previous settings, press [EXIT] twice and then press [F1] = NO at the *SAVE* prompt. Any programming changes will be discarded and you will be returned to the data display.
- To leave the *User Program* and return to measurement mode, press [EXIT] twice and then press [F2] = YES at the *Save* prompt. Your programming changes will be entered into the meter's memory, and you will be returned to the data display.

Note: *See the SAVE submenu section on page 1-52 of this chapter for more information on this function.*

Entering System Data for a Channel

Refer to Figure A-1 on page A-1.

1. To enter the Channel PROGRAM menu, press [F1] or [F2] (depending on the desired channel) at the User PROGRAM prompt.
2. To program the SYSTM submenu, press [F2] at the Channel PROGRAM prompt.

IMPORTANT: *Do not confuse this SYSTM submenu, which is used to enter channel-specific information, with the SYSTM submenu of the GLOBL menu, which is used to enter information applicable to both channels.*

3. Enter a *Channel Label* of up to 9 characters. Press [ENT].
4. Enter a *Channel Message* of up to 21 characters. Press [ENT].
5. At the *Equation* prompt, select the gas equation used by the meter to perform its flow rate calculations. Press [F1] = STAND to display data in *Standard* volumetric units, or press [F2] = ACTUL to display data in *Actual* volumetric units.
 - a. If you selected *Standard*, press [F1] to have the meter treat the gas as an *ideal gas* or press [F2] to have the meter treat the gas as a *supercompressed gas*.

Entering System Data for
a Channel (cont.)

6. Use the [→] and [F1]-[F4] keys to select the *Volumetric Units* for the data display, as shown in Table 1-2 below.

Table 1-2: Available Volumetric/Totalizer Units

English	Metric
Actual Units	
ACF = Actual Cubic Feet	ACM = Actual Cubic Meters
KACF = Thousands of ACF	KACM = Thousands of ACM
MMACF = Millions of ACF	MMACM = Millions of ACM
Standard Units	
SCF = Standard Cubic Feet	SCM = Standard Cubic Meters
KSCF = Thousands of SCF	KSCM = Thousands of SCM
MMSCF = Millions of SCF	MMSCM = Millions of SCM

7. Use the [F1]-[F4] keys to select the *Volumetric Time* for the data display.
8. Use the [F1]-[F4] keys to select the *Vol Decimal Digits* (the number of digits to the right of the decimal point) in the data display.
9. Use the [→] and [F1]-[F4] keys to select the *Totalizer Units* for the data display.
10. Use the [F1]-[F4] to select the *Total Decimal Digits* (the number of digits to the right of the decimal point) in the data display.
11. If *Static Density?* is set to NO in the ADVAN submenu, go to *Procedure Options* on the next page. Otherwise, proceed as follows:
 - a. Use the [F1]-[F4] keys to select the *Mass Flow* units for the data display.
 - b. Use the [F1]-[F4] keys to select the *Mass Flow Time* units for the data display.
 - c. Use the [F1]-[F4] to select the *MDOT Decimal Digits* (the number of digits to the right of the decimal point) in the data display.
 - d. Use the [F1]-[F4] to select the *Mass (Totalizer)* for the data display.
 - e. Use the [F1]-[F4] to select the *Mass Decimal Digits* for the data display.

Procedure Options

After completing the above steps, the meter returns to the Channel PROGRAM prompt. Continue as follows:

- To continue programming the meter, refer to the menu maps in Appendix A and navigate to the desired menu. Then, proceed to the appropriate section of this manual for instructions.
- To leave the *User Program* and retain the previous settings, press [EXIT] twice and then press [F1] = NO at the *SAVE* prompt. Any programming changes will be discarded and you will be returned to the data display.
- To leave the *User Program* and return to measurement mode, press [EXIT] twice and then press [F2] = YES at the *SAVE* prompt. Your programming changes will be entered into the meter's memory, and you will be returned to the data display.

Entering Pipe Data

To program the transducer and pipe parameters via the PIPE submenu, complete the following steps and refer to Figure A-1 on page A-1.

1. To enter the Channel PROGRAM menu, press [F1] or [F2] (depending on the desired channel) at the User PROGRAM prompt.
2. Press [F3] at the Channel PROGRAM prompt.
3. Enter the *Transducer Number* (normally engraved on the head of the transducer). Press [ENT]. If there is no engraved number, complete the steps below. Otherwise, proceed to step 4.

IMPORTANT: *Special transducers, which have no engraved number on the head, are rarely used. Examine the transducer head carefully for a number.*

Special Transducers

- a. Assign a number between 91 and 99 to the *Special Transducer* and press [ENT]. (The meter will only accept values from 1 to 199.)
- b. Press [F2] to select Shear wave as the *Transducer Type*.

Note: *While three choices are available (Rayleigh, Shear wave or wetted transducers), the GC868 is designed for use with Shear wave clamp-on transducers. Consult the factory before selecting Rayleigh or wetted transducers.*

- c. Use the [→] and [F1]-[F4] keys to select the *Frequency* of the special transducer. The meter can not transmit an excitation voltage at the transducer's natural frequency without this data.

Special Transducers (cont.)

- d. Enter the special transducer *Time Delay* (T_w) value supplied by the factory. Press [ENT]. (The meter will only accept values from 0 to 1,000 μ sec.)

Note: T_w is the time required for the transducer signal to travel through the transducer and its cable. This time delay must be subtracted from the transit times of the upstream and downstream transducers to ensure an accurate measurement.

- e. Press [F1]-[F4] to select the *Wedge Material*. The available options include VHT (very high temperature), MT (medium temperature), HT (high temperature) and OTHER. Refer to the data sheet supplied with your transducer to determine the appropriate setting.
- f. Use the numeric keys to enter the *Wedge Angle* (the angle of the ultrasonic transmission) provided by the factory in degrees and press [ENT].
- If you selected OTHER in step d, use the numeric keys to enter the *Wedge Soundspeed* in ft/sec or m/sec provided by the factory and press [ENT]. The meter proceeds to step 5.

Wedge Temperature

4. Use the numeric keys to enter the *Wedge Temperature* in deg F provided by the factory and press [ENT].

Pipe Material

5. Press [F1]-[F4] to select the *Pipe Material*. Press [->] to access additional options, as listed in Table 1-3 below.

Table 1-3: Pipe Materials

Pipe Material Category	Specific Material
Steel	Carbon Steel or Stainless Steel
Iron	Ductile Iron or Cast Iron
Cu - Copper	None
Al - Aluminum	None
Brass	None
CuNi - Copper/Nickel	70% Cu 30% Ni or 90% Cu 10% Ni
Glass	Pyrex, Flint, or Crown
Plastic	Nylon, Polyester, Polypropylene, PVC (CPVC), Acrylic
Other*	Any material

- Depending on the pipe material choice, another prompt may ask you to select the *Specific Material*.
- If you have selected OTHER, enter the pipe material *Sound Speed*. Press [ENT].

- Pipe OD*
6. Enter the known *Pipe OD* or circumference and use the [F1]-[F4] keys to select the appropriate units. Press [ENT]. (The meter will only accept values from 1/8 to 648 in.)
- The required pipe data may be obtained by measuring either the pipe outside diameter (OD) or circumference at the transducer installation site. Alternatively, the information may be obtained from tabulated data for standard pipe sizes.
- Pipe Wall*
7. Enter the known thickness of the *Pipe Wall*, in the same units used for the pipe OD. Press [ENT]. (The meter will only accept values from 0 to 4 in.)
- If the pipe wall thickness is not known and cannot be conveniently measured, look up the value in a table of standard pipe size data or use the Model GC868's on-line *Help Menu*.
- Fluid Type*
8. Press [F1] = natural gas, [F2] = air, [F3] = steam, or [F4] = any other gas to select the *Fluid Type*.
- If OTHER was selected, enter the speed of sound (in feet per second) in the gas to be measured. Press [ENT]. (The meter will only accept values from 125 to 9,000 ft/sec.)
- Reynolds Correction*
9. The *Reynolds Correction* factor is a number based on the kinematic viscosity and flow rate of the gas. At the prompt, press [F1] to turn Reynolds Correction off, or [F2] to turn it on.
- If you select Reynolds Correction, the GC868 asks for the *Kinematic Viscosity* of the gas (available in the brochure *Sound Speeds and Pipe Size Data*, 914-004). Use the numeric keys to enter the correct value and press [ENT].
- Calibration Factor*
10. Enter a value for the flow *Calibration Factor* and press [ENT]. The default value is 1.00. (The meter will only accept values from 0.5000 to 2.0000.)
- Number of Traverses*
11. Press [F1]-[F4] to select the desired *Number of Traverses* (times the ultrasonic signal traverses the pipe, from 1 to 9).
- Note:** *Most clamp-on gas applications require a single traverse (1(Z)).*
- Transducer Spacing*
12. The *Transducer Spacing* prompt displays the spacing of the transducers, as calculated from the information you have entered. Record this number in Appendix B, *Data Records*, and use it to properly space the transducers.
- Note:** *If necessary, you can overwrite the spacing shown at the previous prompt (using the numeric keys) to match the actual physical spacing of the transducers. GE does not recommend overwriting the spacing. If you must, do not change the spacing by more than $\pm 10\%$ from the value shown.*

Procedure Options

After completing the above steps, the meter returns to the Channel PROGRAM prompt. Continue as follows:

- To continue programming the meter, refer to the menu maps in Appendix A and navigate to the desired menu. Then, proceed to the appropriate section of this manual for instructions.
- To leave the *User Program* and retain the previous settings, press [EXIT] twice and then press [F1] = NO at the *SAVE* prompt. Any programming changes will be discarded and you will be returned to the data display.
- To leave the *User Program* and return to measurement mode, press [EXIT] twice and then press [F2] = YES at the *SAVE* prompt. Your programming changes will be entered into the meter's memory, and you will be returned to the data display.

Setting Up Inputs/Outputs The following specific tasks may be performed via the I/O submenu:

- Enter a zero cutoff value to eliminate low flow reading fluctuations
- Set up any optional temperature and/or pressure inputs

Refer to the menu map in Figure A-2 on page A-2.

Note: *Remember to record all programmed data in Appendix B, Data Records.*

1. To enter the Channel PROGRAM menu, press [F1] or [F2] (depending on the desired channel) at the User PROGRAM prompt.

2. To enter the I/O submenu, press [F4] at the Channel PROGRAM prompt.

Zero Cutoff

3. Enter the desired *Zero Cutoff* value and press the [ENT] key. A value of 0.1 ft/s (0.03 m/s) is recommended, but values from 0–1 ft/s (0–0.3 m/s) are acceptable.

Temperature Input

4. At the *Temperature Input* prompt, press [F1] to enter a constant temperature value or press [F \times] to select the option card in Slot \times that will supply the live temperature input.

Note: *Each slot that contains an option card with an analog input assigned to TEMP or an RTD input will appear on the option bar. If the process temperature is stable, a fixed value may be used, but most applications require a live temperature input.*

5. Do one of the following:

- If you selected FIXED, enter the known fixed process temperature. Press [ENT]. (The meter will only accept values from -148° to 662° F.)
- If you selected SLOT \times ,
 - a. Press [F1] to select input A or press [F2] to select input B. The inputs were labeled during setup.

Note: *The set up of input A is used as an example. Identical procedures would be used to set up input B.*

- b. Enter the *Base Temperature* (from -148° to 662° F), and press [ENT]. The ratio of this value to the actual temperature is used to calculate the standard volumetric flow.

Pressure Input

6. At the *Pressure Input* prompt, press [F1] to enter a constant pressure value or press [F \times] to select the option card in Slot X that will supply the live pressure input.

Note: *Each slot that contains an option card with an analog input assigned to PRESR will appear on the option bar. If the process pressure is stable, a fixed value may be used, but most applications require a live pressure input.*

7. Do one of the following:

- If you selected FIXED, enter the known fixed process pressure. Press [ENT]. (The meter will only accept values from 0–5000 psia.)
- If you selected SLOT X,
 - a. Press [F1] to select input A or press [F2] to select input B. The inputs were labeled during setup.
 - b. Enter the *Base Pressure* (standard) value for the process, and press the [ENT] key. (The meter will only accept values from 0–7,508 psia or 0 to 500 bar.)

If you selected a supercompressed gas in the SYSTM menu, a series of additional prompts appears. Otherwise, the program returns to the Channel PROGRAM prompt.

- c. Enter the *Specific Gravity for the Forward Flow* and press [ENT]. (The meter will only accept values from 0.1000 to 1.5000.)
- d. Enter the *Specific Gravity for the Reverse Flow* and press [ENT]. (The meter will only accept values from 0.1000 to 1.5000.)
- e. Enter the *Percentage of Carbon Dioxide for the Forward Flow* and press [ENT]. (The meter will only accept values from 0 to 40%.)
- f. Enter the *Percentage of Carbon Dioxide for the Reverse Flow* and press [ENT]. (The meter will only accept values from 0 to 40%.)
- g. Press [F1] to select a *Fixed Nitrogen Forward Input*.
- h. Enter the *Percentage of Nitrogen for the Forward Flow* and press [ENT]. (The meter will only accept values from 0 to 40%.)
- i. Press [F1] to select a *Fixed Nitrogen Reverse Input*.
- j. Enter the *Percentage of Nitrogen for the Reverse Flow* and press [ENT]. (The meter will only accept values from 0 to 40%.)

Procedure Options

After completing the above steps, the meter returns to the Channel PROGRAM prompt. Continue as follows:

- To continue programming the meter, refer to the menu maps in Appendix A and navigate to the desired menu. Then, proceed to the appropriate section of this manual for instructions.
- To leave the *User Program* and retain the previous settings, press [EXIT] twice and then press [F1] = NO at the *SAVE* prompt. Any programming changes will be discarded and you will be returned to the data display.
- To leave the *User Program* and return to measurement mode, press [EXIT] twice and then press [F2] = YES at the *SAVE* prompt. Your programming changes will be entered into the meter's memory, and you will be returned to the data display.

Entering Setup Data

The signal limits and response times for the Model GC868 are specified via the SETUP submenu. It includes four submenus:

- SIGNL - set the parameters related to the transducer signal
- AVRG - specify the response of the meter to step changes
- INIT - initialize all parameters to default values.
- ADVAN - set parameters for special operations

To enter the SETUP submenu, press [→] and [F1] at the Channel PROGRAM prompt, and refer to Figure A-2 on page A-2 and Figure A-3 on page A-3. Remember to record all programmed data in Appendix B, *Data Records*.

Setting Signal Limits

Use this option to set the limits for the incoming signal and other parameters affecting the transducer signal. For example, the programmed signal strength low limit may be used to determine the trigger point for an alarm. Table 1-4 on page 1-24 summarizes the default values and limits for parameters in this menu.

Caution!

The SIGNL default settings are suitable for most applications. Before changing any of these parameters, consult the factory.

Complete the following steps to enter the signal parameters:

1. To enter the SIGNL submenu, press [F1] at the SETUP window.
2. Press [ENT] to accept the current *Signal Low Limit* value or enter a new value and press [ENT].

The default value for this parameter is 20 and values from –20 to 100 are acceptable. The E1: LOW SIGNAL error message appears when the signal strength falls below the programmed SIGNAL LOW LIMIT value. See the *Service Manual* for a discussion of error codes.

3. Press [ENT] to accept the current *Signal High Limit* value or enter a new value and press [ENT].

The default value for this parameter is 68 and values from 25 to 100 are acceptable. The EX: LOW SIGNAL error message appears when the signal strength falls above the programmed SIGNAL HIGH LIMIT value. See the *Service Manual* for a discussion of error codes.

Setting Signal Limits (cont.)

4. Press [ENT] to accept the current *Cor. Peak Limit* value or enter a new value and press [ENT].

The default value for this parameter is 100 and values from 0 to 500 are acceptable. The E4: SIGNAL QUALITY error message appears when the signal quality falls below the programmed COR. PEAK LIMIT value. See the *Service Manual* for a discussion of error codes.

5. Press [ENT] to accept the current *Soundspeed +- Limit* value or enter a new value and press [ENT].

The default value for this parameter is 10% and values from 1% to 50% are acceptable.

6. Press [ENT] to accept the current *Velocity Low Limit* value or enter a new value and press [ENT].

The default value for this parameter is -75.0 ft/sec (-23 m/sec) and values from -500 to 500 ft/sec (-150 to 150 m/sec) are acceptable. The E3: VELOCITY RANGE error message appears when the calculated fluid velocity is less than the programmed VELOCITY LOW LIMIT value. See the *Service Manual* for a discussion of error codes.

7. Press [ENT] to accept the current *Velocity High Limit* value or enter a new value and press [ENT].

The default value for this parameter is 75.0 ft/sec (23 m/sec) and values from -500 to 500 ft/sec (-150 to 150 m/sec) are acceptable. The E3: VELOCITY RANGE error message appears when the calculated fluid velocity exceeds the programmed VELOCITY HIGH LIMIT value. See the *Service Manual* for a discussion of error codes.

Note: *The actual maximum velocity depends on your application. Refer to Table 1-1, Table 1-2 and Table 1-3 of the Startup Guide for a list of maximum velocities.*

8. Press [ENT] to accept the current *Acceleration* value or enter a new value and press [ENT].

The default value for this parameter is 5.0 ft/sec² (4.6 m/sec²) and values from 0 to 100 ft/sec² (0 to 30 m/sec²) are acceptable. The E6: CYCLE SKIP error message appears when the calculated fluid velocity changes by more than the programmed ACCELERATION LIMIT value from one reading to the next. See the *Service Manual* for a discussion of error codes.

Setting Signal Limits (cont.) **9.** Press [ENT] to accept the current *Amp. Discrim Low* value or enter a new value and press [ENT].

IMPORTANT: *Consult the factory before performing this step.*

The amplitude discriminator measures the size of the transducer signal received by the Model GC868. The default value for this parameter is 14 and values from 0 to 100 are acceptable. The E5: AMPLITUDE error message appears when the amplitude discriminator falls below the programmed AMP. DISCRIM LOW value. See the *Service Manual* for a discussion of error codes.

10. Press [ENT] to accept the current *Amp. Discrim High* value or enter a new value and press [ENT].

IMPORTANT: *Consult the factory before performing this step.*

The amplitude discriminator measures the size of the transducer signal received by the Model GC868. The default value for this parameter is 34 and values from 0 to 100 are acceptable. The E5: AMPLITUDE error message appears when the amplitude discriminator exceeds the programmed AMP. DISCRIM HIGH value. See the *Service Manual* for a discussion of error codes.

11. Press [ENT] to accept the current *Delta T Offset* value or enter a new value and press [ENT].

IMPORTANT: *Consult the factory before performing this step.*

An offset between the upstream and downstream transit times is specified at this prompt. The default value for this parameter is 0 μsec and values from $-1,000$ to $1,000$ μsec are acceptable.

12. Press [ENT] to accept the current *Skat T Offset* value or enter a new value and press [ENT].

At this prompt, specify a time measurement offset that compensates for any shift resulting from cross-correlation. The default value for this parameter is 12.6 μsec and values from -500 to 500 μsec are acceptable.

Note: *If you enter a value of 0 for this command, you enable a special mode of operation, ACTIVE SKAN T-OFFSET, that dynamically calculates the offset.*

Setting Signal Limits (cont.) **13.** Press [ENT] to accept the current % of *Peak* value or enter a new value and press [ENT].

The percentage of peak used to calculate the transit times and Delta T is specified at this prompt. The default value for this parameter is 80% and values from 1 to 100% are acceptable.

14. Use the [→] and [F1]-[F4] keys to select one of the preset values for the *XMIT Sample Size* from the option bar.

IMPORTANT: *Consult the factory before performing this step.*

Both the upstream and downstream transducers transmit ultrasonic pulses in bursts, which consist of a series of transmit pulses. XMIT SAMPLE SIZE determines how many bursts are sent in one direction before sending in the other direction. The default value for this parameter is 8 and values of 2, 4, 8, 16 and 32 are acceptable.

15. Press [ENT] to accept the current *M>S_Switch* value or enter a new value and press [ENT].

IMPORTANT: *Consult the factory before performing this step.*

If the burst mode is set to Skan/Measure (S/M), the meter switches from Skan to Measure Mode when Delta T is less than the *M>S_Switch* value. **DO NOT** change this value unless advised to do so by the factory. The default value for this parameter is 5 μ sec and values from 0 to 250 μ sec are acceptable.

16. Press [ENT] to accept the current # *shifts* value or enter a new value and press [ENT].

The number of shifts corresponds to the actual number of transmits per cycle (number of signals added together in one direction to produce an averaged signal for one interrogation of the fluid) and need only be changed if the environment is very noisy or the acoustic signal is weak. The default value for this parameter is 3 and values from 0 to 10 are acceptable.

17. Press [ENT] to accept the current *A Divisor* value or enter a new value and press [ENT].

A Divisor is used in the calculation of the Measure Mode integrated threshold level and is not normally changed. The default value for this parameter is 2.5 and values from 0.1 to 10 are acceptable.

18. Press [ENT] to accept the current # *Transmit Pulses* value or enter a new value and press [ENT].

IMPORTANT: *Consult the factory before performing this step.*

Transmit Pulses specifies the number of pulses in a burst. The default value for this parameter is 1 and values from 1 to 16 are acceptable. For difficult conditions (i.e., long paths, high velocity or high temperature), settings as high as 16 may be necessary.

Setting Signal Limits (cont.) **19.** Press [ENT] to accept the current *T Window (Cycles)* value or enter a new value and press [ENT].

IMPORTANT: *Consult the factory before performing this step.*

Normally, the Model GC868 calculates the size of the transmit window based on pipe size and fluid sound speed. However, for special diagnostic purposes, it may sometimes be necessary to reset the window size. The default value for this parameter is 0 and values from 0 to 1000 are acceptable. If you select 0 or 1, the GC868 applies automated calculation, and the following prompt does not appear.

20. Press [ENT] to accept the current *R WINDOW (cycles)* value or enter a new value and press [ENT].

IMPORTANT: *Consult the factory before performing this step.*

Normally, the Model GC868 calculates the size of the receive window based on pipe size and fluid sound speed. However, for special diagnostic purposes, it may sometimes be necessary to reset the window size. The default value for this parameter is 10 and values from 10 to 128 are acceptable.

After completing these steps, the program returns to the SETUP window. Table 1-4 on the next page lists the default values and limits for SETUP parameters.

Setting Signal Limits (cont.)

Table 1-4: Default Values and Limits for SETUP Parameters

Parameter	Default Value	Low Limit	High Limit
Signal Low Limit	50	-20	100
Signal High Limit	68	25	100
Cor. Peak Limit	400	0	500
Soundspeed \pm Limit	10%	1%	50%
Velocity Low Limit	-75.0 ft/sec (-23 m/sec)	-500 ft/sec (-150 m/sec)	+500 ft/sec (+150 m/sec)
Velocity High Limit	75.0 ft/sec (23 m/sec)	-500 ft/sec (-150 m/sec)	+500 ft/sec (+150 m/sec)
Acceleration Limit	5.0 ft/sec ² (4.6 m/sec ²)	0	100 ft/sec ² (30 m/sec ²)
Amp. Discrim Low	14	0	100
Amp. Discrim High	34	0	100
Delta T Offset	0	-1,000 μ sec	1,000 μ sec
Skat T Offset	12.6 μ sec	-500 μ sec	500 μ sec
% of Peak	80%	1%	100%
XMIT Sample Size	8	2	32
M>S Switch	5 μ sec	0 μ sec	250 μ sec
# shifts	3	0	10
A Divisor	2.5	0.1	10
# Transmit Pulses	1	1	16
T Window	1	0	1,000
R Window	10	10	128

Setting Response Time

Use this option to specify the number of readings that occur before the meter will respond to a step change in flow rate. In general, the smaller the number of readings, the less steady the display will appear.

1. Press [F2] = AVRG to enter the AVERAGE submenu.
2. Use the [→] and [F1]-[F4] keys to select the desired option. The available response time options are 1, 2, 5, 10, 30, 60 readings and STATS. For best results, select STATS (statistics), as this increases the response time under steady flow conditions while still allowing a rapid response to changes in flow rate.

After completing this step, the program returns to the SETUP window.

Initializing the System

Use this option to initialize (reset) all of the parameters within the SETUP menu to their default values.

1. Press [F3] = INIT.
2. Press [F1] = NO to keep the current values or press [F2] = YES to reset all values to their default settings.

Setting Advanced Parameters

In the ADVAN option, you can enter parameters for a variety of specialized operations. You can set parameters for static density, program tables for steam or natural gas and for multiple K factors, and modify parameters for the Skan and Skan/Measure techniques. To enter the ADVAN submenu, press [F4] at the SETUP window, and refer to Figure A-3 on page A-3.

Static Density

Use this option to specify basic parameters for mass flow measurement.

1. To enter the MASS submenu, press [F1] at the ADVAN window.
2. At the *Static Density?* prompt, press [F1] = NO or [F2] = YES. If you press NO, the GC868 returns to the ADVAN window.
3. If you press YES, select the *Density Type* to calculate Mass Flow: [F1] = Rho (Fluid Density) or [F2] = Mw (Molecular Weight).
4. The next prompt depends upon your selection in step 3.
 - If you select *Rho*,
 - a. The GC868 asks for the type of volumetric flow. Press [F1] to select AcVOL (Actual Volumetric Flow) or [F2] to select StVOL (Standard Volumetric Flow).
 - b. Then enter the *Fluid Density* of the gas to be measured and press [ENT]. (The meter will only accept values from 0.00001-100 lb/ft³.)
 - If you select *Mw*,

Enter the Molecular Weight of the gas to be measured and press [ENT]. (The range is from 0 to 100 g/mol, and the default value is 28.85 g/mol.)

The GC868 program returns to the ADVAN window.

Setting the A Value

In the Skan/Measure Integrate mode, the A value aids in minimizing cycle skipping. Use this option to specify parameters for the A value.

IMPORTANT: *The AVAL default settings are suitable for most applications. Before changing any of these parameters, consult the factory.*

1. To enter the AVAL submenu, press [F2] at the ADVAN window.
2. Use the numeric keys to enter the desired *A_Value Minimum*, and press [ENT]. (The available range is from 75 to 100.)
3. Use the numeric keys to enter the desired *A_Value Maximum*, and press [ENT]. (The available range is from 100 to 125.)
4. Enter the desired *-Offset % of Peak* from 0 to 95%, and press [ENT]. (The default is 20.)
5. Enter the number of *Cycle Count Samples* (from 1 to 40) and press [ENT]. (The default is 8.)
6. Enter the *Cycle #* (from 1 to 100) and press [ENT]. (The default is 1.)

The GC868 returns to the ADVAN window.

Setting Skan/Measure Parameters

Use the MEAS option to modify the parameters of the Skan/Measure modes.

IMPORTANT: *The MEAS default settings are suitable for most applications. Before changing any of these parameters, consult the factory.*

1. Press [F3] to enter the Measurement Settings option.
2. The first prompt asks for the number of cycles in the *MEAS R Window*. While this window is normally 24 cycles wide, the option allows you to customize the width from 1 to 60. Press [ENT] to accept the current value, or enter a new value and press [ENT].
3. Press [F1] to use both skan and measure times, or [F2] to *Use Meas Times only*.
4. Press [F1] to retain skan, or [F2] to *Skip Skan*. If [F2] is selected, the GC868 will skip skan except for every 10th reading, when an error appears, or when the Delta-T exceeds the M>S Switch limit.
5. At the *SkanDT>MeasDT Check?*, press [F1] to omit a test to determine whether the Skan Delta T is greater than the Measure Delta T, or [F2] to apply the test.
6. Enter a value (from 0 to 100 μ sec) for the *Absolute Skan Delta T* to be used in the test in step 5, and press [ENT].
7. The next prompt, *Normalize to 100?*, asks if the program will keep the Skan Delta T within the 0 to 100 range (?), rather than the actual amplitude. Press [F1] to use actual amplitude, or [F2] to normalize the parameter.
8. Press [F1] to omit measurement of SNR (signal to noise ratio), or [F2] to measure SNR. (The default setting is “Yes.”)
 - a. If you measure SNR, the program asks for the *Minimum SNR for Error 4*. (The default is 7.0.) Enter the desired value, and press [ENT].

The GC868 returns to the ADVAN window.

Entering Multiple K Factors In the MULTK option, you can enter velocity or Reynolds Correction values into a K-Factor table. You can thus “curve fit” velocity or Reynolds calibration multiple data points (from several different data sources or flow variables) to the flow rate reported by the GC868.

1. Press [F4] to enter the *Multiple K Factors* option.
2. Press [F1] = NO to disable or [F2] = YES to enable *Multiple K-factors*.
 - If you press NO, the GC868 returns to the ADVAN window.
3. If you press YES, the program asks for the *Custom type* of data. Press [F1] to select velocity data, or [F2] to select Reynolds data.
 - a. If you select a Reynolds table, the meter asks for the *Kinematic Viscosity*. Enter the appropriate value, and press [ENT].
4. Press [F1] = NO to retain the current K-factor table and return to the ADVAN window, or press [F2] = YES to *Edit The K-factor Table*.

Note: *If velocity vs. K-factor data was not provided with the Model GC868, the K-factor table can not be edited.*

- a. Enter the *Number of K-factors* to be entered into the table. Press [ENT]. (The meter will only accept values from 2 to 20.)

IMPORTANT: *When editing the K-factor table, the velocities must be entered in increasing order.*

- b. Enter the *Velocity (or Reynolds) Value* for K-factor number “x”. Press [ENT]. (The meter will only accept values from –30,000 to +30,000 ft/sec.)
- c. Enter the *K-factor* corresponding to velocity or Reynolds number “x”. Press [ENT].
- d. Repeat steps c and d until all of the data points have been entered.

The GC868 returns to the ADVAN window.

Programming a Gas Compressibility Table

In the ZTABL option, you can enter data into a global table to define particular compressibility values. The GC868 can thus implement SonicWare® and other data tables to meet specific applications.

Note: *The table applies to both channels of a 2-channel GC868.*

1. Press [→] and [F1] to enter the ZTABL option.
2. Press [F1] if you do not want to *Use Global Z-table*, or [F2] to program the table. (If you press [F1], the GC868 returns to the ADVAN window.)
3. Use the numeric keys to enter the *Base Compressibility* of the gas, and press [ENT].
4. Enter the number of desired *Pressure Columns*, from 1 to 10. Press [ENT].
 - a. Enter the *Pressure Value* for Column 1. Press [ENT].
 - b. Repeat step a for each succeeding column, until you have programmed all the desired columns.
5. Enter the number of desired *Temperature Rows*, from 1 to 10. Press [ENT].
 - a. Enter the *Temperature Value* for Row 1. Press [ENT].
 - b. Repeat step a for each succeeding row, until you have programmed all the desired rows.
6. Enter the *Z-Factor* for column 1, row 1 (1,1).
7. Repeat step 6 for each succeeding column, row location, until you have programmed the entire table.

The GC868 returns to the ADVAN window.

Setting Correlation Parameters

The CORR option allows you to adjust parameters for the Skan/Correlation technique in the ACTIV menu.

IMPORTANT: *The CORR default settings are suitable for most applications. Before changing any of these parameters, consult the factory.*

1. Press [→] and [F2] to enter the CORR option.
2. Use the [→] and [F1]-[F4] keys to select the desired *Signals per reading*, from 8 to 128. (The default is 8.)
3. Use the numeric keys to enter the desired # *Correlation Xmit Pulses*, from 1 to 16. Press [ENT].
4. Use the [→] and [F1]-[F4] keys to select the desired *Correlation Xmit Code*. The available choices include None, Code A, Code B, Code C and Code D.
5. Enter the value (from 0 to 250 μ sec) for the *C>S (Correlation>Skan) Switch*, and press [ENT].
6. Enter the *% of Peak (Correlation)* from -100 to 100%, and press [ENT].
7. Enter the *Minimum Peak % limit* from -100 to 100%, and press [ENT].
8. Enter the *Maximum Peak % limit* from -100 to 100%, and press [ENT].

The GC868 returns to the ADVAN window.

Setting Skan Parameters

In the SKAN option, you can activate and set parameters for a negative peak percent for both the Skan measurement technique (in the ACTIV submenu) and the Skan portion of the Skan/Measure technique. When negative peak percent is active, the GC868 searches for the maximum negative peak before the positive peak, and then calculates the T at both negative peak percents entered; these times are averaged for the T measurement.

IMPORTANT: *The SKAN default settings are suitable for most applications. Before changing any of these parameters, consult the factory.*

1. Press [→] and [F3] to enter the SKAN option.
2. Press [F1] if you do not want to *Use Negative Peak*, or [F2] to activate negative peak. (If you press [F1], the GC868 returns to the ADVAN window.)
3. Enter the *Minimum Negative Peak %* from -100 to -10%, and press [ENT].
4. Enter the *Maximum Negative Peak %* from -100 to -10%, and press [ENT].

The GC868 returns to the ADVAN window.

Synchronizing Meter Transmissions

The TRANS (Transmit) option appears only if an alarm card has been installed in the GC868. It allows the GC868 and its transducers to operate synchronously with another meter on the same flowcell. When triggered, the alarm card can close a relay when the other meter is transmitting, to prevent conflicting signals.

1. Press [→] and [F4] to enter the TRANS option.
2. Press [F1] if you do not want to activate the *Gate Alarm*, or [F2] to activate the alarm.

Procedure Options

After completing the above steps, the meter returns to the SETUP prompt. Continue as follows:

- To continue programming the meter, refer to the menu maps in Appendix A and navigate to the desired menu. Then, proceed to the appropriate section of this manual for instructions.
- To leave the *User Program* and retain the previous settings, press [EXIT] twice and then press [F1] = NO at the *SAVE* prompt. Any programming changes will be discarded and you will be returned to the data display.
- To leave the *User Program* and return to measurement mode, press [EXIT] twice and then press [F2] = YES at the *SAVE* prompt. Your programming changes will be entered into the meter's memory, and you will be returned to the data display.

Entering Global Data

The GLOBL menu is used to enter information that is not specific to one of the individual channels. Information programmed via this menu is used to compute parameters such as the sum, difference or average of the channel 1 and channel 2 signals. In addition, several general system parameters may be entered in the GLOBL menu.

IMPORTANT: *When calculating the SUM, DIF or AVE readouts, data from the GLOBL-SYSTM submenu is used. Any conflicting data entered in the CH1-SYSTM or CH2-SYSTM submenus is overridden.*

The following submenus are included in the GLOBL menu:

- CLOCK - used to enter the current date and time
- SYSTM - used to specify the units of measure used in calculations
- I/O - used to set up error handling and to configure analog inputs and outputs
- COMM - used to set up the serial communications port
- SECUR - used to specify a programming access password.

After selecting [F3]=GLOBL at the initial programming screen, the following screen appears:

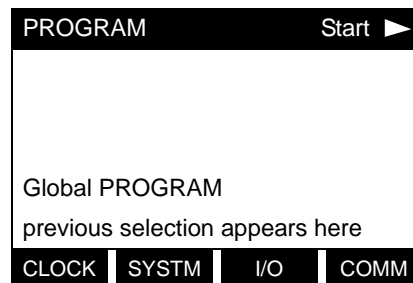

Use the [←] and [→] keys and [F1]-[F4] function keys to select the desired submenu. Complete the steps listed to program each submenu.

Refer to Figure A-4 on page A-4 and Figure A-5 on page A-5, and remember to record all programming data in Appendix B, *Data Records*.

Setting the Clock

Use the CLOCK submenu to enter the current date and time. Refer to Figure A-4 on page A-4. To program the CLOCK submenu, press [F1] at the Global PROGRAM prompt and complete the following steps:

Setting the Date

1. The first prompt displays the programmed *Date*.
 - If the displayed date is correct, press [F1] = OK and proceed to step 2.
 - If the displayed date is incorrect, press [F2] = EDIT to change the date, and complete the steps below.
 - a. Enter the current year and press [ENT]. The allowable range is 0 to 99.
 - b. Use the [←], [→] and [F1]-[F4] keys to select the current month.
 - c. Enter the current day and press [ENT]. The allowable range is 1 to the number of days in the current month.

Setting the Time

2. The next prompt displays the programmed *Time*.
 - If the displayed time is correct, press [F1] = OK to return to the GLOBL prompt.
 - If the displayed time is incorrect, press [F2] = EDIT to change the time, and complete the steps below.
 - a. Press [F1] = AM or [F2] = PM. Then enter the current *Hour* and press [ENT]. The allowable range is 1 to 12.

Note: *A time of 12 PM represents Noon and a time of 12 AM represents Midnight.*

- b. Enter the current *Minutes* and press [ENT]. The allowable range is 0 to 59.
- c. Enter the current *Seconds* and press [ENT]. The allowable range is 0 to 59.

After completing the above steps, the program returns to the GLOBL window.

Entering Global System Data

Refer to Figure A-4 on page A-4. To program this submenu, press [F2] at the Global PROGRAM prompt, and complete the following steps:

1. At the *System Units* prompt, press [F1] = ENG to display parameters and measurements in English units or [F2] = METRC to display parameters and measurements in metric units.
2. Use the [F1]-[F4] keys to select the desired type of *Pressure Units* for display. (See Figure A-4 on page A-4 for all available pressure units.)

Note: *The choices shown on the option bars are determined by the selections made at the previous SYSTEM UNITS prompt.*

- If you have entered the local atmospheric pressure (PSIg, BARg or kPag), the GC868 asks for an *Atmospheric Pressure* value. Enter the value, and press [ENT].
3. At the *Stopwatch Totalizer* prompt, press [F1] = AUTO to measure totals automatically or press [F2] = MNUAL to measure totals manually with the Stopwatch Timer.

If AUTO is selected above, the meter automatically begins totalizing upon leaving the *User Program*. If MNUAL is selected, the console key on the keypad may then be used to start and stop the totalizer. The manner in which the Stopwatch Totalizer responds to an error condition may be set in the I/O submenu.

IMPORTANT: *After setting up the Stopwatch Totalizer, press [CLR] to clear the Stopwatch Totalizer, or the new totals will be added to any previously accumulated totals.*

4. Use the [F1]-[F4] and [→] keys to select the desired *Volumetric Units* for the flow rate display. (See Figure A-4 on page A-4 for all available volumetric and totalizer units.)
5. Use the [F1]-[F4] and [→] keys to select the desired *Volumetric Time* units for the display.
6. Use the [F1]-[F4] keys to select the desired number of *Vol Decimal Digits* to the right of the decimal point in the display.
7. Use the [F1]-[F4] and [→] keys to select the desired *Totalizer Units*.
8. Use the [F1]-[F4] keys to select the desired number of *Total Decimal Digits* to the right of the decimal point in the display.

Mass Flow (static)?

- If the *Static Density?* prompt in the ADVAN option (MASS submenu) is set to NO, the meter returns to the GLOBL prompt.
- If *Static Density?* is set to YES, complete the following steps.
 1. Use the [F1]-[F4] and [→] keys to select the desired *Mass Flow* units for the flow rate display. (See Figure A-4 on page A-4 for all available mass flow units.)
 2. Use the [F1]-[F4] keys to select the desired *Mass Flow Time* units for the display.
 3. Use the [F1]-[F4] keys to select the desired number of *MDOT Decimal Digits* in the mass flow rate display.
 4. Use the [F1]-[F4] keys to select the desired units for the *Mass Totalizer*.
 5. Use the [F1]-[F4] keys to select the number of *Mass Decimal Digits* in the totalized mass flow display.

After completing the above steps, the program returns to the GLOBL window.

Procedure Options

After completing the above steps, the meter returns to the GLOBL window. Continue as follows:

- To continue programming the meter, refer to the menu maps in Appendix A and navigate to the desired menu. Then, proceed to the appropriate section of this manual for instructions.
- To leave the *User Program* and retain the previous settings, press [EXIT] twice and then press [F1] = NO at the *SAVE* prompt. Any programming changes will be discarded and you will be returned to the data display.
- To leave the *User Program* and return to measurement mode, press [EXIT] twice and then press [F2] = YES at the *SAVE* prompt. Your programming changes will be entered into the meter's memory, and you will be returned to the data display.

Note: See the *SAVE submenu* section on page 1-52 of this chapter for more information on this function.

Setting Up Global Inputs/
Outputs

The I/O submenu allows users to program error handling responses, as well as both built-in and optional analog outputs and cards. To program this submenu, press [F3] at the Global PROGRAM prompt, and refer to Figure A-5 on page A-5.

- Press [F1] to set up error handling, or
- Press [F2] to set up any inputs or outputs.

Complete the steps below to program each submenu.

Note: *Be sure to record all programmed data in Appendix B, Data Records.*

Selecting Error Handling

This menu option permits programming of the manner in which the Model GC868's totalizers respond during an error condition. See Chapter 2, *Error Codes and Screen Messages*, of the *Service Manual* for a discussion of the built-in error codes.

1. At the I/O prompt, press [F1] (*Error*).
2. Press [F1] if you want the GC868 to *Hold* the last "good" reading and continue to totalize, based on that reading, or press [F2], *No Up*, if you want the meter to stop totalizing.
3. Press [F1] = NO to disable 2-path error handling, or press [F2] = YES to enable 2-path error handling.

For the AVE mode, the 2-path error handling option is intended for applications where two sets of transducers are installed in the same location in the same pipe to improve accuracy. With this function enabled, the Model GC868 performs error handling only if both channels are in error. If this function is disabled, error handling occurs when either channel goes into error. Specific responses of the display and the totalizer to the 2-path error handling option are listed in Table 1-5 below.

Table 1-5: 2-Path Error Response Options

Option	Totalizer Response
NO	Outputs the average of CH1 and CH2 totals, regardless of the error state of either channel.
YES	1. If one channel is in error, totalizing continues. 2. If both channels are in error, totalizing stops.

The *User Program* automatically returns to the Global I/O prompt.

Setting Up Option Cards

The Model GC868 has two built-in analog outputs, which are assigned to Slot 0. Also, a variety of option cards may be installed in the six expansion slots. See Chapter 1, *Installation*, of the *Startup Guide* for a complete description of the available option cards.

Note: *For this discussion, Slot x will be used to reference any of the specific expansion slots (Slot 1 - Slot 6). If the number of a slot with an installed option card does not appear, the card may not have been initialized or it may be defective. Call the factory for assistance.*

- Use the [←] and [→] and the [F1]-[F4] keys to select the desired slot number. (Only those slots which contain an option card will appear on the option bar.)

Refer to the menu map in Figure A-4 on page A-4 and complete the following steps to setup and/or scale the Model GC868's analog inputs and outputs.

Slot X Analog Outputs

1. Use the [F1]-[F4] keys to set up outputs A, B, C or D, respectively.

Note: *The set up of output A is used as an example. Identical procedures would be used to set up the other outputs.*

2. Press [F1] = OFF to disable output A and return to the previous prompt, or press [F2] = 0-20 m or [F3] = 4-20 m to specify the desired range for output A.
3. Use the [←] and [→] and [F1]-[F4] keys to select a *Channel* option for the data source.
4. Use the [←] and [→] and [F1]-[F4] keys to specify the desired *Output Measurement* parameter.
5. Enter the *Zero* value for the low end of the chosen output range. Press [ENT].
6. Enter the *Full* value for the high end of the chosen output range. Press [ENT].
7. Press [F1]-[F4] to select the desired *Error Response* option, as described in Table 1-6 below.

Table 1-6: Error Response Options

Option	Display Response
HOLD	Holds the last "good" reading.
LOW	Forces the outputs to the low set point.
HIGH	Forces the outputs to the high set point.
OTHER	Allows user to enter 4-20 mA error level in mA.

8. Press [F1]-[F4] to set up another output or press [EXIT] to select another slot for set up.

Setting Up Alarms

1. Use the [F1]-[F3] keys to set up alarm relays A, B, or C, respectively.

Note: *The set up of alarm A is used as an example. Identical procedures would be used to set up the other alarms.*

2. Press [F1] = OFF to disable Alarm A and return to the previous prompt, or press [F2] = HIGH, [F3] = LOW or [F4] = FAULT to specify the type for Alarm A.
3. Press [F1] = NO for standard operation or [F2] = YES for *Failsafe* operation.
4. Use the [←] and [→] and [F1]-[F4] keys to select a *Channel* option for the data source.
5. The prompts now vary with your choice in step 2.
 - If you selected FAULT, proceed to step 6.
 - If you selected HIGH or LOW, complete the steps below.
 - a. Use the [←] and [→] and [F1]-[F4] keys to specify the desired *Output Measurement* parameter.
 - b. Enter a value for the trigger point of the alarm and press [ENT].
6. To select the *Fault Type* that will trigger the alarm, press [F1] = FLOW, [F2] = OTHER (non-flow), or [F3]= ALL.
7. Press [F1]-[F3] to set up another alarm or press [EXIT] to select another slot for set up.

Setting Up Totalizer/
Frequency Outputs

1. Press [F1]-[F4] to set up outputs A, B, C or D, respectively.
2. Press [F1] = OFF to disable output A and return to the previous prompt, or press [F2] = FREQ or [F3] = TTLZR to designate output A as a frequency or a totalizer output, respectively.

Note: *The setup of output A is used as an example. Identical procedures would be used to set up the other outputs.*

3. Use the [←] and [→] and [F1]-[F4] keys to select a *Channel* option for the data source.
 - To program a frequency output, go to step 4.
 - To program a totalizer output, go to step 5.

Frequency Output

4. The FREQ output, [F2], produces a frequency pulse that is proportional to the output measurement. Complete the steps below to program the frequency output.
 - a. Use the [←] and [→] and [F1]-[F4] keys to specify the desired *Output Measurement* parameter.
 - b. Enter the *Base* value for the low end of the frequency output range and press [ENT].
 - c. Enter the *Full* value for the high end of the frequency output range. Press [ENT].
 - d. Enter a value between 1 and 10,000 for the *Full Scale Frequency*. Press [ENT].
 - e. Use the [F1]-[F4] keys to select the desired *Error Option*, the way the display responds during an error condition. Available options are shown in Table 1-7 below. Then skip to step 6 on the next page.

Table 1-7: Error Response Options for Frequency Output

Option	Display Response
HOLD	Holds the last "good" reading.
LOW	Forces the outputs to the low setpoint.
HIGH	Forces the outputs to the high setpoint.
OTHER	Allows user to enter Hertz error level.

Totalizer Output

5. The TTLZR output, [F3], issues one pulse per selected volume of flow. The meter produces a pulse each time the programmed amount of flow passes through the pipe. Complete the steps below to program the totalizer output.
 - a. Press [F1] = +TOTL to totalize the forward flow, [F2] = -TOTL to totalize the reverse flow, [F3] = +MASS (if available) to totalize the forward mass flow or [F4] = -MASS (if available) to totalize reverse mass flow.
 - b. Enter a value from 50 to 500,000 μ sec for the *Minimum Pulse ON Time* and press [ENT].

Note: *A complete pulse consists of equal amounts of ON and OFF times. Choose a value that is compatible with the frequency counter to be used.*

- c. Enter a value for the number of measurement *Units/Pulse* and press [ENT].

Press [F1]-[F4] to set up another totalizer/frequency output or press [EXIT] to select another slot for setup.

Setting Up Analog Inputs

1. Press [F1] to set up input A or [F2] to set up input B.

Note: *The set up of input A is used as an example in this manual. Identical procedures would be used to set up input B. (An analog input option card may contain one standard analog input and one RTD analog input.)*

2. Enter a *Label* of up to eight characters for input A and press [ENT].
3. At the *Input Measurement* prompt, press [F1] = OFF to disable input A and return to the previous prompt, or press [F2] = PRESR (pressure), [F3] = TEMP (temperature) or [F4] = SPEC (special) to designate the input.
4. Do one of the following:
 - If you selected PRESR or TEMP, proceed to step 5.
 - If you selected SPEC, complete the steps below.
 - a. Enter an *Input Name* and press [ENT].
 - b. Enter the *Input Units* of measurement and press [ENT].
5. Enter the *Zero Value* for the low end of the chosen input range and press [ENT].
6. Enter the *Full Scale Value* for the high end of the chosen input range and press [ENT].
7. Press [F1]-[F2] to set up another input or press [EXIT] to select another slot for setup.

Option Card RTD Inputs

Option cards with RTD inputs have a temperature range of -100° to 350°C . Complete the following steps to set up the two RTD inputs of an option card installed in Slot x:

1. Press [F1] to set up RTD input A or [F2] to set up RTD input B.

Note: *The setup of RTD input A is used as an example. Identical procedures would be used to set up RTD input B.*

2. Enter a label of up to eight characters and press [ENT].
3. At the Input Measurement prompt, press [F1] = OFF to disable RTD input A and return to the previous prompt, or press [F2] = TEMP to enable RTD input A.
4. Enter the *Zero Value* for the low end of the chosen input range and press [ENT].
5. Enter the *Full Scale Value* for the high end of the chosen input range and press [ENT].
6. Press [F1]-[F2] to set up another input or press [EXIT] to select another slot for set up.

Procedure Options

After completing the above steps, the meter returns to the Global I/O prompt. Continue as follows:

- To continue programming the meter, refer to the menu maps in Appendix A and navigate to the desired menu. Then, proceed to the appropriate section of this manual for instructions.
- To leave the *User Program* and retain the previous settings, press [EXIT] twice and then press [F1] = NO at the *SAVE* prompt. Any programming changes will be discarded and you will be returned to the data display.
- To leave the *User Program* and return to measurement mode, press [EXIT] twice and then press [F2] = YES at the *SAVE* prompt. Your programming changes will be entered into the meter's memory, and you will be returned to the data display.

Note: *See the SAVE submenu section on page 1-52 of this chapter for more information on this function.*

Setting Up Communications

The Model GC868 flowmeter can transmit stored data and displayed readings to a remote ANSI terminal or a personal computer by connecting the meter's RS232 interface to the serial port of the PC. In addition, the Model GC868 can receive and execute remote commands via this link. The meter can also be configured with a MODBUS option card for MODBUS (RS485) communications, a Foundation Fieldbus option card for Foundation Fieldbus communications, or a MODBUS/TCP option card for MODBUS communications over the Ethernet, if desired.

Note: *To set Fieldbus communications parameters, see Appendix D, Foundation Fieldbus Communications.*

Use the COMM submenu to set the RS232, MODBUS, Ethernet and MODBUS/TCP communications port parameters and to enter a network identification number. A network identification number is required to use the *GE Instrument Data Manager* or *PanaView* software. To program the COMM submenu, press [F4] at the initial Global PROGRAM screen and complete the following steps. Refer to the menu map in Figure A-4 on page A-4.

1. Use the [←] and [→] and [F1]-[F4] keys to select the desired *Baud Rate*. The available rates are 300, 600, 1200, 2400, 4800, 9600 and 19,200 baud.
2. Use the [←] and [→] and [F1]-[F4] keys to select the number of *UART Bits*.
3. Enter a *Network ID* number between 1 and 254 and press [ENT]. The default number is 1.

A network ID number is only necessary for communication with the *GE Instrument Data Manager* or *PanaView* software. See the software *User's Manual* for more information.

IMPORTANT: *If the network ID number is changed, communication with the Instrument Data Manager or PanaView must be re-established with the new ID number.*

MODBUS (RS485) Parameters

If your GC868 does not include an option card for MODBUS communications, you have completed programming the COMM submenu. However, if you have installed a MODBUS option card, the following additional prompts appear.

1. Press [F1]-[F4] to select the desired *MODBUS Baud Rate* from four selections: 2400, 4800, 9600 and 19,200.
2. Press [F1]-[F3] to set the *MODBUS Parity* as none, odd or even.
3. Press [F1] to select one *MODBUS Stop Bit*, or [F2] to select two stop bits.
4. Use the numeric keys to enter a *MODBUS Address* (from 1 to 247) and press [ENT].

MODBUS/TCP Parameters

If your GC868 does not include an option card for MODBUS/TCP communications, you have completed programming the COMM submenu. However, if you have installed a MODBUS/TCP option card, complete the following steps:

1. Press [F3] to select the appropriate *MODBUS Baud Rate* of 9600.
2. Press [F1]-[F3] to set the *MODBUS Parity* as none, odd or even.
3. Press [F1] to select one *MODBUS Stop Bit*, or [F2] to select two stop bits.
4. Use the numeric keys to enter a *MODBUS Address* (from 1 to 247) and press [ENT].

Procedure Options

After completing the above steps, the meter returns to the Global PROGRAM prompt. Continue as follows:

- To continue programming the meter, refer to the menu maps in Appendix A and navigate to the desired menu. Then, proceed to the appropriate section of this manual for instructions.
- To leave the *User Program* and retain the previous settings, press [EXIT] twice and then press [F1] = NO at the *SAVE* prompt. Any programming changes will be discarded and you will be returned to the data display.
- To leave the *User Program* and return to measurement mode, press [EXIT] twice and then press [F2] = YES at the *SAVE* prompt. Your programming changes will be entered into the meter's memory, and you will be returned to the data display.

Note: See the *SAVE submenu section on page 1-52 of this chapter for more information on this function.*

MODBUS Register Map

When equipped with the optional MODBUS output card, the GC868 flow transmitter can send flow data and diagnostic information to a flow computer (or SCADA) serially, using a Gould-type RTU protocol. In this case, only the MODBUS function command, 3 (read multiple registers), 6 (write multiple registers) is valid. The format for the data exchange is as follows:

- The **send** command (initiated by the host flow computer or controller) comes in the form:
 [time delimiter]<Addr><3><First Register MSB>
 <First Register LSB><Register Count MSB>
 <Register Count LSB><CRC Low><CRC High>[time delimiter]
- The response (initiated by the host flow computer or controller) comes in the form:
 [time delimiter]<Addr><3><Byte count><Data.....>
 <CRC Low><CRC High>[time delimiter]

The format for the returned data types is as follows:

- Integer (16 bit Integer) <MSB><LSB>
 1 Register - 16 bit integer
- Integer (32 bit IntegerI) <MSB><LSB><LSB><LSB>
 2 Register - 32 bit integer
- Floating Point (FP) <EXP><MAN><MAN><MAN>
 2 Registers - 32 bit IEEE floating point number

To request specific parameters from the GC868 via the MODBUS, the control system must enter the appropriate register number. Only registers 1 through 90 are available for MODBUS communications, while registers 508 through 512 are used by the GC868 to store the MODBUS parameters. For details, see Table 1-8 on the next page.

Table 1-8: MODBUS Registers for a 2-Channel GC868

MODBUS Reg #	DPR Hex Addr	Description	Scaling (decimal places)	Size in Bytes
1	0	1" Clear Ch1 Totalizers"	--	2 (16 bit signed)
2	2	1" Clear Ch2 Totalizers"	--	2 (16 bit signed)
3	4	Ch1 Velocity	2	4 (2 16-bit int)
5	8	Ch1 Act Volumetric	#Q DIGITS	4 (IEEE 32 bit)
7	C	Ch1 Std Volumetric	#Q DIGITS	4 (IEEE 32 bit)
9	10	Ch1 Fwd Totals	#T DIGITS	4 (2 16 bit int)
11	14	Ch1 Rev Totals	#T DIGITS	4 (2 16 bit int)
13	18	Ch1 #Tot Digits	0	2
14	1A	Ch1 Mass Flow	#M DIGITS	4 (IEEE 32 bit)
16	1E	Ch1 Fwd Mass Totals	#MT DIGITS	4 (2 16-bit int)
18	22	Ch1 Rev Mass Totals	#MT DIGITS	4 (2 16-bit int)
20	26	Ch1 #Mass Tot Digits	0	2
21	28	Ch1 Timer	2	4 (2 16-bit int)
23	2C	Ch1 Error Code	0	2
24	2E	Ch1 Sound Speed	3	4 (2 16-bit int)
26	32	Ch1 Density	4	4 (2 16-bit int)
28	36	Ch1 Sig Strength Upstream	1	4 (2 16-bit int)
30	3A	Ch1 Sig Strength Downstream	1	4 (2 16-bit int)
32	3E	Ch1 Temperature	2	4 (2 16-bit int)
34	42	Ch1 Pressure	3	4 (2 16-bit int)
36	46	Ch2 Velocity	2	4 (2 16-bit int)
38	4A	Ch2 Act Volumetric	#Q DIGITS	4 (IEEE 32 bit)
40	4E	Ch2 Std Volumetric	#Q DIGITS	4 (IEEE 32 bit)
42	52	Ch2 Fwd Totals	#T DIGITS	4 (2 16 bit int)
44	56	Ch2 Rev Totals	#T DIGITS	4 (2 16 bit int)
46	5A	Ch2 #Tot Digits	0	2
47	5C	Ch2 Mass Flow	#M DIGITS	4 (IEEE 32 bit)
49	60	Ch2 Fwd Mass Totals	#MT DIGITS	4 (2 16-bit int)
51	64	Ch2 Rev Mass Totals	#MT DIGITS	4 (2 16-bit int)
53	68	Ch2 #Mass Tot Digits	0	2
54	6A	Ch2 Timer	2	4 (2 16-bit int)
56	6E	Ch2 Error Code	0	2
57	70	Ch2 Sound Speed	3	4 (2 16-bit int)
59	74	Ch2 Density	4	4 (2 16-bit int)

Table 1-8: MODBUS Registers for a 2-Channel GC868 (Continued)

MODBUS Reg #	DPR Hex Addr	Description	Scaling (decimal places)	Size in Bytes
61	78	Ch2 Sig Strength Upstream	1	4 (2 16-bit int)
63	7C	Ch2 Sig Strength Downstream	1	4 (2 16-bit int)
65	80	Ch2 Temperature	2	4 (2 16-bit int)
67	84	Ch2 Pressure	3	4 (2 16-bit int)
69	88	Avg Velocity	2	4 (2 16-bit int)
71	8C	Avg Act Volumetric	#Q DIGITS	4 (IEEE 32 bit)
73	90	Avg Std Volumetric	#Q DIGITS	4 (IEEE 32 bit)
75	94	Avg Fwd Totals	#T DIGITS	4 (2 16 bit int)
77	98	Avg Rev Totals	#T DIGITS	4 (2 16 bit int)
79	9C	Avg #Tot Digits	0	2
80	9E	Avg Mass Flow	#M DIGITS	4 (IEEE 32 bit)
82	A2	Avg Fwd Mass Totals	#MT DIGITS	4 (2 16-bit int)
84	A6	Avg Rev Mass Totals	#MT DIGITS	4 (2 16-bit int)
86	AA	Avg #Mass Tot Digits	0	2
87	AC	Avg Timer	2	4 (2 16-bit int)
89	B0	⁵ Avg Error Code	0	2
90	B2	Avg Sound Speed	3	4 (2 16-bit int)
508	3F6	² MODBUS baud rate	0	2
509	3F8	³ MODBUS parity	0	2
510	3FA	⁴ MODBUS stop bits	0	2
511	3FC	MODBUS meter addr	0	2
512	3FE	RESERVED	---	---

Notes:**1. Clear Totalizers:**

flag from the 8051 to clear either the Channel 1 or Channel 2 totalizers.

2. MODBUS baud rate:

5 = 2400, 6 = 4800, 7 = 9600, 8=19200

3. MODBUS parity:

0 = none, 1 = odd, 2 = even

4. MODBUS stop bits:

1 = 1 stop bit, 2 = 2 stop bits

5. AVG Error Code:

0=Both Ch1 and Ch2 are in error.

1=Ch1 only is in error

2=Ch2 only is in error

3=Both channels are error free

Activating Security

In order to prevent unauthorized tampering with the flowmeter's programming, the Model GC868 is equipped with a security feature that locks out the following menus:

- Program Menu [PROG]
- Calibration Menu [CAL]
- Log Menu [LOG]
- Clear Menu [CLR]

When the system is locked, access to the above menus will be denied unless the correct password is entered. The Model GC868 is shipped with a *default password*, which is given later in this section. For increased security, the default password should be changed.

IMPORTANT: *Once the system has been locked, it can only be unlocked by entering the password, because access to the SECUR submenu is restricted.*

To program the SECUR submenu, press [→] and [F1] at the Global PROGRAM prompt. Refer to Figure A-4 on page A-4.

IMPORTANT: *It is recommended that all program parameters be recorded before changing the password. (This information should be recorded in Appendix B, Data Records, as a matter of routine.) If the password is lost, the site data is not retrievable and will have to be re-entered.*

1. At the *Lock Out* prompt, press [F1] = UNlck to unlock the system and return to the Global PROGRAM prompt, or press [F2] = LOCK to lock the system.

Note: *If the system was unlocked at the above prompt, the following three prompts do not appear.*

2. *Enter the current Password (2719 is the default password) and press [ENT].*
3. At the *?Edit Password* prompt, press [F1] = NO to leave the password unchanged and return to the Global PROGRAM prompt, or press [F2] = YES to enter a new password.

IMPORTANT: *Since the default password is printed in this manual, a new password should be entered. If the password is ever lost, contact the factory for assistance.*

Activating Security (cont.)

4. *Enter the New Password* and press [ENT]. Any combination of letters and numbers up to a total of 21 characters may be used as a password.

Note: *Keep in mind that the password may have to be entered frequently from the keypad. A long and/or complex password may soon become annoying to use.*

5. *Verify the New Password* by entering it again and press [ENT]. Be sure to record the new password in a safe place.

Procedure Options

After completing the above steps, the meter returns to the Global PROGRAM prompt. Continue as follows:

- To continue programming the meter, refer to the menu maps in Appendix A and navigate to the desired menu. Then, proceed to the appropriate section of this manual for instructions.
- To leave the *User Program* and retain the previous settings, press [EXIT] twice and then press [F1] = NO at the *SAVE* prompt. Any programming changes will be discarded and you will be returned to the data display.
- To leave the *User Program* and return to measurement mode, press [EXIT] twice and then press [F2] = YES at the *SAVE* prompt. Your programming changes will be entered into the meter's memory, and you will be returned to the data display.

Note: *See the SAVE submenu section on the following page for more information on this function*

Saving Site Files

The currently programmed site data may be stored in the Model GC868's non-volatile memory by saving it as a site file. Up to ten site file names, consisting of up to five characters each, may be stored at any given time. To enter the SAVE menu, press [F4] at the initial *User Program* screen. Refer to Figure A-4 on page A-4.

1. Enter a new site file name and press [ENT], or use the [←], [→] and [F1]-[F4] keys to select and overwrite an existing site file.

Note: *The option bar will show only as many choices as there are existing site files.*

If ten site files are already stored in memory, an existing site file must be deleted before a new site file name can be assigned. See Chapter 5, *Clearing Data*, for details.

When a site file is stored in memory, it becomes the active site file until another site file is created or retrieved. (See the next section for instructions on retrieving a site file.) To verify that the site file has been saved, use the [↑] key to scroll back to the SITE NAME prompt and see if the name appears on the option bar (use the [←] and [→] keys to scroll through the list, if necessary). Whenever a new site file name is saved, it is automatically assigned to the next available function key.

IMPORTANT: *The CLOCK and I/O data is not saved with the site file, while the SYSTM and COMM data is saved with the site file.*

2. Use the [←] and [→] and [F1]-[F4] keys to select another menu, or press [EXIT] to leave the *User Program* and return to measurement mode.

Recalling Site Files

Any site file currently stored in the Model GC868's non-volatile memory may be recalled at any time. Up to ten site file names, consisting of up to five characters each, may be stored at any given time. To enter the RECLL menu, press [→] and [F1] at the initial *User Program* screen.

1. Use the [←], [→] and [F1]-[F4] keys to select and recall an existing site file.

Note: *The option bar shows only as many choices as there are existing site files. The files are listed in chronological order by creation date.*

Upon recall, the selected site file becomes active and all of its programmed parameters become current.

IMPORTANT: *The CLOCK and I/O data is not recalled with the site file, while the SYSTM and COMM data is recalled with the site file.*

Note: *If you have loaded a site file into a GC868, but the option cards are not in the same slots or programmed the same way as when the site file was first saved, the GC868 displays a warning to review slot information. This display does not mean that the option cards have lost their program information!*

2. Use the [←] and [→] and [F1]-[F4] keys to select another menu, or press [EXIT] to leave the *User Program* and return to measurement mode.

Chapter 2

Displaying Data

- Introduction..... 2-1
- The BIG Submenu..... 2-2
- The DUAL Submenu..... 2-3
- The GRAPH Submenu..... 2-4
- The LOG Submenu..... 2-7
- Displaying the Transducer Signal..... 2-11
- Setting the LCD Backlight..... 2-14
- Activating Sleep Mode..... 2-15

Introduction

This chapter explains how to display measurement data in various formats. Each of the two display screen panes may be programmed independently.

Note: *The instructions in this chapter assume that the left display pane is active. If the right display pane is active, simply change all [F1]-[F4] designations to [F5]-[F8].*

The following submenus are included in the *Display Menu*:

- BIG - displays a single measurement in large size text
- DUAL - permits the simultaneous display of two measurements, in the same screen pane, in standard size text
- GRAPH - displays a graph of either velocity or volumetric flow versus time
- LOG - displays the data stored in a log file either graphically or numerically
- SIGNL - graphically displays any one of five transducer signals versus time
- BACKL - sets the time that the LCD display backlight remains on before it is automatically turned off.
- SLEEP - blanks out the display screen until a key is pressed.

Refer to Figure A-6 on page A-6 and proceed to the appropriate section to set up the Model GC868 display screen(s), using one of the listed submenus.

The BIG Submenu

The BIG format, which is the Model GC868's default power up format, displays one measurement in large print. To select the BIG format and the measurement to display in this format, follow the instructions in this section.

Upon power up, a standard measurement mode display (similar to the one shown below) appears. Press the appropriate side of the [SCREEN] key to activate the desired pane of the display screen, and complete the following steps:

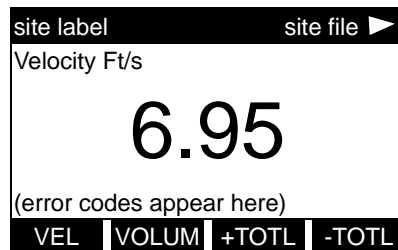

The default power up screen is already in BIG mode. If a different display mode is active, access the *Display Menu* by pressing the [DISP] key.

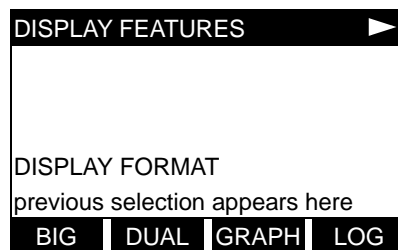

Press [F1] to select the BIG option. The measurement mode screen reappears with the display in the BIG format.

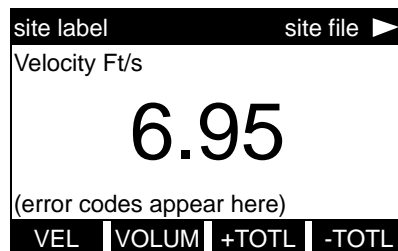

Use the [F1]-[F4], [←] and [→] keys to select the desired display parameter option. See Table 2-1 below for a complete description of the available options.

Table 2-1: Measurement Parameter Options

Option Bar Choice	Description
[F1] = VEL	Flow Velocity
[F2] = VOLUM	Volumetric Flow
[F3] = +TOTL	Forward Totalized Volume Flow
[F4] = -TOTL	Reverse Totalized Volume Flow
[→] + [F1] = TIME	Total Flow Measurement Time
[→] + [F2] = MDOT	Mass Flow
[→] + [F3] = +MASS	Forward Totalized Mass Flow
[→] + [F4] = -MASS	Reverse Totalized Mass Flow
[→] + [→] + [F1] = DIAG	Diagnostic

Note: See Chapter 3, Operation, of the Startup Guide for more details on selecting a measurement parameter to display.

The DUAL Submenu

The DUAL format displays two measurements simultaneously in normal print. To select the DUAL format and the measurements to display in this format, follow the instructions in this section.

Upon power up, a standard measurement mode display (similar to the one shown below) appears in BIG format. Press the appropriate side of the [SCREEN] key to activate the desired pane of the display screen, and complete the following steps:

1. To access the *Display Menu*, press the [DISP] key.
2. Press [F2] = DUAL. The measurement mode display reappears and the display is now in the DUAL format.
3. Use the [F1]-[F4], [←] and [→] keys to select the desired display parameter option. See Table 2-1 on page 2-2 for a complete description of the available options.

Note: See Chapter 3, *Operation, of the Startup Guide for more details on selecting a measurement parameter to display.*

With the DUAL format display screen active, when a measurement parameter is selected, the top line of the prompt area will be changed to show that parameter. The parameter previously displayed at the top of the display is moved to the bottom of the display, and the previous bottom parameter is no longer shown.

The GRAPH Submenu

The GRAPH submenu permits the display of either the flow velocity, mass flow or the volumetric flow on an XY bar graph, with a specified time interval on the x-axis. This section describes the procedures for setting up and using the graph format.

Setting Up the GRAPH Format

Press the appropriate side of the [SCREEN] key to activate the desired pane of the display screen, and complete the following steps:

1. To access the *Display Menu*, press the [DISP] key.
2. Press [F3] = GRAPH.
3. Press [F1]-[F3] to graph the *Flow Velocity*, *Volumetric Flow* or *Mass Flow*, respectively.
4. Use the [←], [→] and [F1]-[F4] keys to select the desired *Time Increment*.
5. Enter a maximum value for the *Y-axis* (vertical) scale that is larger than the maximum expected reading and press [ENT].
6. At the *Y Range* prompt, press [F1] to graph only positive Y values or press [F2] to graph both positive and negative Y values.

After the Y RANGE is entered, the Model GC868 automatically begins taking measurements and displays them in the specified graphical format. Proceed to the next section for a discussion of manipulating the graphical display.

Using the GRAPH Format

While viewing data in the GRAPH format, the function keys are programmed to permit a variety of actions. These options are described in detail below.

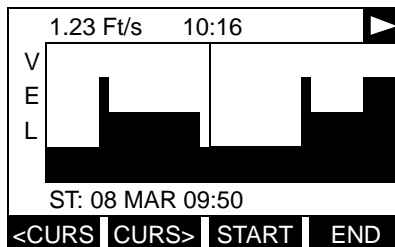

Use the [←], [→] and [F1]-[F4] keys to select the desired option. See Table 2-2 on page 2-6 for a listing of the available choices.

At any given time, 120 data points will be shown on the GRAPH screen. The *cursor*, which is displayed as a vertical line that extends the full height of the graph window, can be used to select any one of these data points.

The typical screen shown above is for a *Velocity vs. Time* graph with only the positive y-axis displayed. The measurement parameter (VEL) is shown to the left of the y-axis and there is a *message line* below the graph that initially indicates the starting date and time of the graphed data. Notice that most of the locator bar has been replaced by a *status line* in standard video that shows the value, units and time of the measurement at the current cursor location. However, there is still an inverse video *pointer* at the far right of this line to indicate that additional option bar choices are available.

Note: *The date in the message line includes only the day and the month (not the year), and the times in the status line and the message line include only the hours and minutes (not the seconds).*

Because the times displayed in the GRAPH format are in whole minutes only, movement of the cursor may not result in a visible change in the posted times. For example, if a TIME INCREMENT of 30 seconds has been programmed, two presses of either cursor movement key will be required to change the displayed time by one minute.

Using the GRAPH Format
(cont.)

Table 2-2: Graph Display Options

Option Bar Choice	Description
[F1] = <CURS	Moves the cursor to the left and displays the corresponding measurement value and time in the status line: (i.e. 6.85 Ft/s 10:38)
[F2] = CURS>	Moves the cursor to the right and displays the corresponding measurement value and time in the status line: (i.e. 5.31 Ft/s 10:38)
[F3] = START	Moves the cursor all the way to the left side of the graph and posts the starting date and time in the message line: (i.e. ST: 08 MAR 10:38)
[F4] = END	Moves the cursor all the way to the right side of the graph and posts the ending date and time in the message line: (i.e. END 08 MAR 11:14)
[→] + [F1] = YMAX	Displays the programmed maximum Y value in the message line: (i.e. YMAX 25.0 Ft/s)
[→] + [F2] = T INC	Displays the programmed time increment value in the message line: (i.e. T INC 30 seconds)
[→] + [F3] = EXIT	Leaves the GRAPH format and returns the display to the previous data format. (The [EXIT] key on the keypad will also perform this function.)

The LOG Submenu

The LOG submenu permits the display of the data in a log file either graphically or numerically. Although the Model GC868 can display all of the data in a log file, screen size limitations prevent the simultaneous display of the complete log file. Therefore, the function keys must be used to view the remaining data. Follow the instructions in this section to display a log file in the desired format.

Entering the LOG Submenu

Press the appropriate side of the [SCREEN] key to activate the desired pane of the display screen, and complete the following steps:

1. To access the *Display Menu*, press the [DISP] key.
2. Press [F4] = LOG.
3. Use the [←], [→] and [F1]-[F4] keys to select the desired log file to display. At the NAME prompt, the option bar will show the names of all log files that are currently stored in memory. If there are no log files currently stored in memory, the following prompt will appear instead:

```

DISPLAY FEATURES
DISPLAY FORMAT
logging
All Logs Cleared!
hit key

```

There are no log files currently stored in memory. Either all of the log files have been cleared or no log files have yet been created. Press any key to return to measurement mode.

If the All Logs Cleared! prompt appears, at least one log file must be created and stored in memory before the *Display Log* function can be accessed. See Chapter 3, *Logging Data*, for instructions on creating a log file. After at least one log file is stored in memory and selected at the NAME prompt of the LOG submenu, proceed to the next step.

4. At the *Format* prompt, press [F1] to display the selected log in numeric format or press [F2] to display the selected log in graphical format.
5. Do one of the following:
 - If you pressed [F1], go to the next page.
 - If you pressed [F2], go to page 2-9.

Numeric Format

The Model GC868 can log up to three parameters simultaneously. Each set of data values is called a *record*, and up to 120 consecutive records can be stored in a *page*. A *log file* can consist of up to 120 pages. The numeric log display, which shows one record at a time, includes the following components:

- page number
- record number
- time and date of creation
- measurement value set
- error messages (if any)

Upon choosing NUM at the FORMAT prompt, the first record of the selected log file is displayed in a screen similar to the following:

```

PAGE# 1      REC# 80
              09 MAR 98
              11.66 Ft/s
              1.32 KACF/MI
              6.91 KACF
E5: Amplitude
<CURS | CURS> | <PAGE | PAGE>
    
```

Use the [←], [→] and [F1]-[F4] keys to view additional records or to exit the log display. The options are listed in Table 2-3 below.

In the numeric display screen, the locator bar (except for the inverse video pointer at the far right) is replaced by a standard video display of the page number and record number. The first line of the prompt area shows the time and date that the record was created, and the next three lines list the values for the three logged parameters. Finally, any error condition that existed at the time the record was taken is indicated by an error code in the bottom line of the prompt area.

Table 2-3: Numeric Log Display Options

Option Bar Choice	Description
[F1] = <CURS	display previous record on the current page
[F2] = CURS>	display the next record on the current page
[F3] = <PAGE	display the previous page
[F4] = PAGE>	display the next page
[→] + [F1] = START	display the first record on the current page
[→] + [F2] = END	display the last record on the current age
[→] + [F3] = EXIT	Leave the numeric LOG display and return to the previous data format. (The [EXIT] key on the keypad will also perform this function.)

Graphical Format

After choosing PLOT at the FORMAT prompt, the programming sequence continues as follows:

6. Enter a maximum value for the *Y-axis* (vertical) scale that is larger than the maximum expected reading. Press [ENT].
7. At the *Y Range* prompt, press [F1] to graph only positive *Y* values or press [F2] to graph both positive and negative *Y* values.

After the *Y RANGE* is entered, the Model GC868 automatically displays the chosen log file records in the specified graphical format.

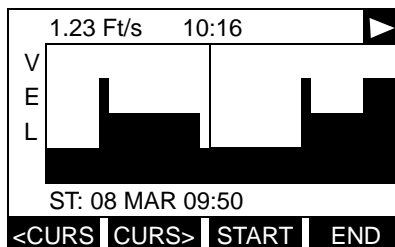

Use the [←], [→] and [F1]-[F4] keys to select the desired option. The options are listed in Table 2-4 on page 2-10.

At any given time, the 120 records stored in one page of the log file will be graphed on the display screen. The *cursor*, which is shown as a vertical line that extends the full height of the graph window, can be used to highlight any one of these records.

IMPORTANT: *Only the first of the three logged parameters is displayed in the graphical format of the LOG submenu. Therefore, when creating a log file, be sure to specify the parameter to be graphed at the 1st Value Logged prompt. See Chapter 3, Logging Data, for details on creating a log file.*

In the typical graphical display shown, the first logged parameter (VEL) is shown to the left of the *y-axis* and there is a *message line* below the graph that initially indicates the starting date and time of the current page. Notice that most of the locator bar has been replaced by a *status line* in standard video that shows the value, units and time of the record at the current cursor location. However, there is still an inverse video *pointer* at the far right of this line to indicate that additional option bar choices are available.

Note: *The date in the message line includes only the day and the month (not the year), and the times in the status line and the message line include only the hours and minutes (not the seconds).*

Because the times displayed in the LOG graph are in whole minutes only, movement of the cursor may not result in a visible change in the posted times. For example, if a TIME INCREMENT of 30 seconds has been programmed, two presses of either cursor movement key will be required to change the displayed time by one minute.

Graphical Format (cont.)

Table 2-4: Graphical Log Display Options

Option Bar Choice	Description
[F1] = <CURS	Move the cursor one record to the left and display the value and time of that record in the status line: (i.e. 6.85 Ft/s 10:38)
[F2] = CURS>	Move the cursor one record to the right and display the value and time of that record in the status line: (i.e. 5.31 Ft/s 10:38)
[F3] = <PAGE	Display the previous page of records
[F4] = PAGE>	Display the next page of records
[→] + [F1] = START	Move the cursor to the first record on the current page and post the date and time of that record in the message line: (i.e. ST: 08 MAR 10:38)
[→] + [F2] = END	Move the cursor to the last record on the current page and post the date and time of that record in the message line: (i.e. END 08 MAR 11:14)
[→] + [F3] = YMAX	Display the programmed maximum Y value in the message line: (i.e. YMAX 25.0 Ft/s)
[→] + [F4] = T INC	Display the time increment value, as set when the log file was created, in the message line: (i.e. T INC 30 seconds)
[←] + [F1] = EXIT	Leave the graphical LOG display and return the display to the previous data format. (The [EXIT] key on the keypad will also perform this function.)

Displaying the Transducer Signal

The SIGNAL submenu permits the direct graphical display of several transducer signals. Specifically, the signals listed in Table 2-5 below may be viewed in this format.

Note: *Only one side of the display (either left or right) can show a signal at any given time.*

Table 2-5: Available Transducer Signals

Transducer Signal	Description
Skam Types	
Sup	upstream Skam signal
Sdown	downstream Skam signal
Cup	upstream Skam correlation
Cdown	downstream Skam correlation
Measure Types	
Mup	upstream Measure signal
Mdown	downstream Measure signal

Note: *The Measure type signals (Mup and Mdown) are only available if one of the S/M burst techniques was selected in the ACTIV menu.*

Refer to Figure A-6 on page A-6 and complete the following steps to display the transducer signals. Press the appropriate side of the [SCREEN] key to activate the desired pane of the display screen, then proceed as follows:

Note: *For this discussion, it is assumed that the left pane of the display screen is active. If the right pane is active, it is only necessary to replace the [F1]-[F4] keys designations by the [F5]-[F8] keys.*

1. To access the *Display Menu*, press the [DISP] key.
2. Press [→] and [F1] = SIGNAL.
3. Press [F1] to display the Skam type signals or press [F2] to display the Measure type signals.

Note: *If the Skam burst technique was selected in the ACTIV menu, the Signal to Display prompt does not appear and the Measure type signals are not available. To access these signals, the S/M burst technique must be selected.*

The signal graph is a plot of signal amplitude (y-axis) vs. time in microseconds (x-axis). When the SIGNAL display screen first appears, it may briefly remain blank. As soon as the signal is acquired, processed and loaded into the display memory, the graph will appear. A *cursor*, which is displayed as a vertical line that extends the full height of the graph window, is used to highlight any point in time along the x-axis.

Displaying the Transducer Signal (cont.)

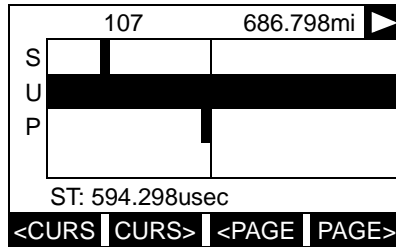

Use the [←], [→] and [F1]-[F4] keys to select the desired option. The options are listed in Table 2-6 below.

The typical display screen shown has the Sup transducer signal listed to the left of the y-axis and there is a *message line* below the graph that initially indicates the starting date and time of the graphed signal. Notice that most of the locator bar has been replaced by a *status line* in standard video that shows the signal amplitude and the time (in microseconds) of the measurement at the current cursor location. However, there is still an inverse video *pointer* at the far right of this line to indicate that additional option bar choices are available.

Table 2-6: Graphical Log Display Options

Option Bar Choice	Description
[F1] = <CURS	Move the cursor to the left and display the amplitude and time in the status line: (i.e. 107 686.798mi)
[F2] = CURS>	Move the cursor to the right and display the amplitude and time in the status line: (i.e. 107 686.798mi)
[F3] = <PAGE	Display the previous page
[F4] = PAGE>	Display the next page
[→] + [F1] = START	Move the cursor to the start of the current page and post the starting date and time in the message line: (i.e. ST: 451.798usec)
[→] + [F2] = END	Move the cursor to the end of the current page and post the ending date and time in the message line: (i.e. END: 744.298usec)
[→] + [F3] = YMAX	Display the maximum Y value, which is set to 128 divisions in arbitrary units, in the message line.
[→] + [F4] = T INC	Display the time increment value in the message line. This is based on the frequency of the transducers and would equal 0.125 msec for a 1 MHz transducer.
[←] + [F1] = EXIT	Leave the graphical SIGNAL display and return the display to the previous data format. (The [EXIT] key on the keypad will also perform this function.)

Displaying the Transducer Signal (cont.)

In addition to the functions available on the option bar, some of the numeric keys are used to specify which transducer signal is displayed and to scale the resulting graph. Table 2-7 below lists these functions.

Table 2-7: Numeric Key Functions

Key	Function
1	Scroll down the transducer signal list
2	Scroll up the transducer signal list
4	Expand the graph vertically
5	Return expanded graph to previous size
7	Compress graph horizontally
8	Return compressed graph to previous size

In summary, three basic functions are performed with the numeric keys:

- **Signal Selection:** use the “1” and “2” keys to select a transducer signal for display by scrolling through the list of available signals.
- **Vertical Scaling:** The “4” and “5” keys are used to scale the graph vertically. Each press of the “4” key doubles the height of the graph, while each press of the “5” key halves the height of the graph. The three available scale factors are 1x, 2x and 4x.
- **Horizontal Scaling:** The “7” and “8” keys are used to scale the graph horizontally. Each press of the “7” key doubles the T INC value (2x horizontal compression), while each press of the “8” key halves the T INC value (2x horizontal expansion). The four available compression ratios are 1x, 2x, 4x and 8x.

To return to the standard data screen either select EXIT from the option bar or press the [EXIT] key on the keypad.

Setting the LCD Backlight Use the BACKL submenu to specify the number of minutes the LCD display backlight remains on before it is automatically turned off. Press the appropriate side of the [SCREEN] key to activate the desired pane of the display screen, then proceed as follows:

Note: *For this discussion, it is assumed that the left pane of the display screen is active. If the right pane is active, replace the [F1]-[F4] keys designations by the [F5]-[F8] keys.*

1. To access the *Display Menu*, press the [DISP] key.
2. Press [→] and [F2] = BACKL.
3. Use the numeric keys to enter a value from 1 to 60 minutes and press [ENT]. To keep the backlight on constantly, enter a value of 0 and press [ENT].

The Model GC868 will automatically return to the previous data display screen and the programmed backlight timeout interval will begin.

If no entries are made from the keypad before the backlight timeout interval expires, the backlight will automatically be turned off. At the next keypad entry, the backlight will be turned on and the specified timeout interval will begin again.

Activating Sleep Mode

During times when the display is not in use, use the SLEEP submenu to temporarily suspend LCD display activity, which allows the Model GC868 to process data more quickly. Press the appropriate side of the [SCREEN] key to activate the desired pane of the display screen, then proceed as follows:

Note: *For this discussion, it is assumed that the left pane of the display screen is active. If the right pane is active, replace the [F1]-[F4] keys designations by the [F5]-[F8] keys.*

1. To access the *Display Menu*, press the [DISP] key.
2. Press [→] and [F3] = SLEEP. The message “LCD SLEEP MODE -Press any key. . .” appears.
3. To reactivate the display and return to the previous data screen, press any key on the keypad. The Model GC868 will automatically return to the previous data display screen.

Note: *With BIG as the selected display format, exiting SLEEP mode may not erase the sleep mode message and the data screen will be superimposed on the message. If this occurs, simply enter the DISP menu and reselect the BIG format to refresh the screen. See the instructions earlier in this chapter.*

Chapter 3

Logging Data

Introduction.....	3-1
Creating a Standard Log.....	3-2
Checking the Memory.....	3-7
Stopping a Log	3-8
Creating an ERROR Log.....	3-9

Introduction

This chapter explains how to use the Model GC868's data logging capability. The LOG menu, which is accessed by pressing the [LOG] key on the keypad, is divided into four submenus:

- STD - used to log up to three of the available measurement data parameters
- MEM - used to check the data logger memory to determine if the specified log will exceed the available memory
- STOP - used to terminate current data logging activity
- ERROR - used to log any generated error messages.

Up to twenty standard or error log files may be created and stored in battery-backed memory. Each log file contains up to three measurement parameters, the log start time and date, the log end time and date, the time interval between updates, and any error messages. Error logs record data only when an error message is generated.

The Model GC868 allocates up to 120 *pages* of memory, each of which can contain up to 120 *records*, for data logging. Each page is assigned a *header*, to distinguish one page from another. The header contains the log title, start date and time, end date and time, and the time increment. Each record contains the date and time of the measurement and the values for the three logged parameters.

Note: *Each log file uses at least one page of memory, and the same page can not be shared by two different logs.*

Since a fixed amount of memory is allocated for data logging, the number of active logs, the log time increments, and the length of the log runs will all affect how much memory is available for additional logging. For example, a log that updates every 5 seconds will use more memory than a log that updates every 6 minutes, assuming that they both run for the same length of time.

After a log file has been created, it may be displayed, printed, cleared or uploaded to a personal computer. Refer to the appropriate chapters of this manual for specific instructions.

Refer to Figure A-8 on page A-8 and proceed to the appropriate section for the desired LOG submenu. Each submenu may be followed in the sequence shown or the [↑] and [↓] keys may be used to scroll through the prompts.

Creating a Standard Log

Use the STD submenu to create a new standard log and to select the parameters to log, the log start time and date, the log end time and date, and the time increment. Also, any log file already stored in memory may be inspected and/or changed.

Press the appropriate side of the [SCREEN] key to activate the desired pane of the display screen, and complete the following steps:

1. To access the *Log Menu*, press the [LOG] key.
 - a. If you have activated the security feature (see Chapter 1, *Programming Site Data*, page 1-50 for details), enter the assigned password and press [ENT].
 2. Press [F1] = STD.
 3. Use the [←], [→] and [F1]-[F4] keys to inspect a completed log or to change an active log, or enter a new name (up to 5 characters) and press [ENT] to create a new log file.
- Note:** *At the NAME prompt, the option bar will show the names of all completed or active log files that are currently stored in memory. Recall that a flashing asterisk (*) appears at the far right of the locator bar if the Model GC868 is currently logging data (see Chapter 3, Operation, of the Startup Guide).*
4. At the *Log Message* prompt, enter a brief description (up to 21 characters) of the log. Press [ENT].
 5. Use the [←], [→] and [F1]-[F4] keys to select the first parameter to be logged. See Table 3-1 below for a list of the available options.

IMPORTANT: *Only the first parameter logged may be graphically displayed in the LOG Submenu of the Display Menu. Keep this in mind when selecting a parameter. See Chapter 2, Displaying Data, for instructions.*

Table 3-1: Measurement Parameter Options

Option Bar Choice	Description
[F1] = VEL	Flow Velocity
[F2] = VOLUM	Volumetric Flow
[F3] = +TOTL	Forward Totalized Volume Flow
[F4] = -TOTL	Reverse Totalized Volume Flow
[→] + [F1] = MDOT	Mass Flow
[→] + [F2] = +MASS	Forward Totalized Mass Flow
[→] + [F3] = -MASS	Reverse Totalized Mass Flow
[→] + [F4] = DIAG	Diagnostic

Creating a Standard Log (cont.)

Refer to Chapter 3, *Diagnostics*, of the *Service Manual* for a discussion of the many parameters accessible via the DIAG option.

Note: *The units assigned to the parameters in Table 3-1 on page 3-2 are those selected in the User Program (SYSTEM submenu).*

6. Use the [←], [→] and [F1]-[F4] keys to select the second parameter to be logged.
7. Use the [←], [→] and [F1]-[F4] keys to select the third parameter to be logged.
 - If you selected a totalized value for display, go to step 8.
 - If you did not, go to step 9.
8. At the *Set Log Totals to 0* prompt, press [F1] to leave the log totals at their present value or press [F2] to reset the log totals to zero. Choosing YES at this prompt only resets the log totals to zero and has no effect on the meter totals.
9. Press [F1] to create a non-circular log or press [F2] to create a circular log.

Log Type

A non-circular log automatically stops when the meter runs out of memory or the specified END TIME is reached. A circular log runs continuously until manually stopped, but only the data from the most recent log cycle is saved. At the start of each cycle, the oldest recorded data is overwritten by the new data from the current cycle.

Caution!

If data from one circular log cycle exceeds the meter's memory capacity, the earliest logged data will be lost.

STARTTIME Prompt

10. Press [F1] to accept the displayed start time or press [F2] to enter a different start time. To start logging immediately, press [F3].
 - If OK was selected, proceed to step 11.
 - If NOW was selected, proceed to step 12 if you selected a the non-circular log or to step 14 for a circular log.
 - If EDIT was selected, complete the steps listed on the next page.

STARTTIME Prompt (cont.)

- a. Press [F1]-[F2] to select AM or PM. Then, enter the desired *Hour* (1-12) and press [ENT]. (Entry of a start time earlier than the current time will generate an error message.)
- b. Enter the desired *Minutes* and press [ENT]. The acceptable range is 0 to 59.
- c. Enter the desired *Seconds* and press [ENT]. The acceptable range is 0 to 59.

START DATE Prompt

11. Press [F1] to accept the displayed *Start Date* or press [F2] to enter a different start date. To start logging today, press [F3].
 - If OK or TODAY was selected, proceed to step 12 for a non-circular log or to step 13 for a circular log.
 - Otherwise, complete the following steps to *Edit* the Start Date.
 - a. Enter the desired *Year* and press [ENT]. The acceptable range is 0 to 99.
 - b. Use the [←], [→] and [F1]-[F4] keys to select the desired *Month*.
 - c. Enter the desired *Day* and press [ENT]. The acceptable range is 1 to the number of days in the selected month (28, 29, 30 or 31).

END TIME Prompt

12. Press [F1] to accept the displayed *End Time* or press [F2] to enter a different end time. To select a specific time period for the log to run, press [F3].
 - If OK was selected, proceed to the END DATE prompt.
 - If TIMED was selected, proceed to the LOG TIME prompt.
 - If EDIT was selected, complete the steps on the next page.

Note: *The log END TIME must exceed the log START TIME by at least five minutes. Failure to observe this restriction will result in an error message.*

- END TIME Prompt (cont.)
- a. Press [F1]-[F2] to select AM or PM. Then, enter the desired *Hour* (1-12) and press [ENT]. (Entry of a start time earlier than the current time will generate an error message.)
 - b. Enter the desired *Minutes* and press [ENT]. The acceptable range is 0 to 59.
 - c. Enter the desired *Seconds* and press [ENT]. The acceptable range is 0 to 59.
- END DATE Prompt
13. Press [F1] to accept the displayed end date or press [F2] to enter a different end date. To end the log today, press [F3].
 - If OK or TODAY was selected, proceed to the TIME INCREMENT prompt. Refer to Figure A-8 on page A-8 for a flow diagram of the programming sequences.
 - Otherwise, complete the steps below.
 - a. Enter the desired *Year* and press [ENT]. The acceptable range is 0 to 99.
 - b. Use the [←], [→] and [F1]-[F4] keys to select the desired *Month*.
 - c. Enter the desired *Day* and press [ENT]. The acceptable range is 1 to the number of days in the selected month (28, 29, 30 or 31). The program proceeds to step 15.
- DURATION Prompt
- If a circular log was specified, the programming sequence continues here after the log start time and/or start date is entered.
14. Press [F1] and enter a log duration in hours or press [F2] and enter a log duration in days. When the desired value has been entered, press [ENT]. The program proceeds to step 16.
- LOG TIME Prompt
- If TIMED was selected at step 12, the programming sequence continues here.
15. Use the [←], [→] and [F1]-[F4] keys to select the desired log duration. The available options are: 10min, 30min, 60min, 3 HR, 6 HR, 12 HR and 24 HR.

TIME INCREMENT Prompt Regardless of which of the various options were selected during the previous programming steps, all of the paths converge at this point.

16. Use the [←], [→] and [F1]-[F4] keys to select the desired *Time Increment*. The available options are: 5sec, 10sec, 30sec, 1min, 3min, 6min, 12min, 30min and 60 min.

The time increment is the frequency at which the Model GC868 takes and records data measurements. If any reading takes longer than the programmed time increment, the log is filled in with the next consecutive reading. For example, assume that a velocity value of 3 ft/sec is recorded at 12:00:00 in a log with a time increment of five seconds. If the next reading is 8 ft/sec and it takes the meter 12 seconds to read this value, then both of the missed readings (12:00:05 and 12:00:10) will be filled in with the 8 ft/sec value.

Procedure Options

You have completed entering data for a standard log. You can now do one of the following:

- Use [↑] and [↓] to review the previous menu prompts.
- Press [F1]-[F4] to select one of the LOG submenus.
- To return to the data screen and begin logging data, press the [ENT] key.

Although each log is restricted to only three logged parameters, it is still possible to log more than three parameters. Simply re-enter the STD submenu as many times as necessary to set up additional logs. Select the other desired parameters, and run these logs simultaneously with the first log.

Checking the Memory

Use the MEM submenu to verify that the available log memory is sufficient for the desired log. If the expected amount of logged data will exceed the remaining memory capacity, the Model GC868 suggests that some old logs be cleared to make room for the new log.

Press the appropriate side of the [SCREEN] key to activate the desired pane of the display screen, and complete the following steps:

1. To access the *Log Menu*, press the [LOG] key.
 - a. If you have activated the security feature (see Chapter 1, *Programming Site Data*, page 1-50 for details), enter the assigned password and press [ENT].
2. Press [F2] = MEM.
3. After noting the information, press [ENT] to return to the main *Log Menu* screen.

The MEM screen lists the number of remaining unused memory pages out of the total number of 120 available pages. Also, the number of pages expected to be used by all currently programmed logs is given. If the number of pending pages exceeds the number of free pages, additional memory may be made available by clearing some old logs (see Chapter 5, *Clearing Data*).

If it is undesirable to delete old logs to free up additional memory, the number of pages pending may be reduced by altering the parameters of one or more of the currently active logs. For example, either increasing the time increment or decreasing the total logging time will reduce the memory requirements for a log file. Use the following equations to calculate the number of pages used by a log:

$$\text{number of records} = \frac{\text{length of log}}{\text{time increment}} \quad (3-1)$$

$$\text{number of pages} = \frac{\text{number of records}}{120} \quad (3-2)$$

Consider a log that is set to run for 24 hours with a time increment of 3 minutes. From Equation 3-1, the number of records = $(24 \times 60)/3 = 480$ records. Then, from Equation 3-2 above, the number of pages = $480/120 = 4$ pages. Thus, at least four pages of memory must be available for this log to run to completion. Notice that increasing the time increment to 6 minutes or decreasing the length of the log to 12 hours would reduce the memory requirement to only 2 pages.

Stopping a Log

Use the STOP submenu to terminate a logging process that is currently active. Press the appropriate side of the [SCREEN] key to activate the desired pane of the display screen, and complete the following steps:

1. To access the *Log Menu*, press the [LOG] key.
 - a. If you have activated the security feature (see Chapter 1, *Programming Site Data*, page 1-50 for details), enter the assigned password and press [ENT].

Note: *Once a log is stopped it cannot be restarted, but the log remains in memory. To clear the log from memory, refer to Chapter 5, Clearing Data, for instructions.*

2. Press [F3] = STOP.
3. Use the [←], [→] and [F1]-[F4] keys to select a log file to stop.

Note: *At the NAME prompt, the option bar will show the names of all completed or active log files that are currently stored in memory. Recall that a flashing asterisk (*) appears at the far right of the locator bar if the Model GC868 is currently logging data (see Chapter 3, Operation, of the Startup Guide).*

4. Press [F1] to continue logging and return to the initial *Log Menu* screen. Press [F2] to stop logging and return to the initial *Log Menu* screen.

Procedure Options

Do one of the following:

- Press [F1]-[F4] to enter another LOG submenu.
- Press [EXIT] to return to the data screen.

Creating an ERROR Log

Use the ERROR submenu to create a new error log and to select the logging parameters. An error log updates every 5 seconds (when the display updates), but only if a new error condition occurs. Error logs have a fixed length of 2 pages and contain sixty records per page. Each record shows the time of the error, the measurement parameter values at that time, and the error code message. The logged values of the chosen measurement parameters at the time of the error condition provide valuable troubleshooting information.

Press the appropriate side of the [SCREEN] key to activate the desired pane of the display screen, and complete the following steps:

1. To access the *Log Menu*, press the [LOG] key.
 - a. If you have activated the security feature (see Chapter 1, *Programming Site Data*, page 1-50 for details), enter the assigned password and press [ENT].
2. Press [F4] = ERROR.
3. Use the [←], [→] and [F1]-[F4] keys to inspect a completed log or to change an active log, or enter a new *Name* (up to 5 characters) and press [ENT] to create a new log file.

Note: *The option bar lists all error logs currently stored in memory. Recall that a flashing asterisk (*) appears at the far right of the locator bar if the Model GC868 is currently logging data (see Chapter 3, Operation, of the Startup Guide).*

4. At the Log Message prompt, enter a brief description (up to 21 characters) of the log. Press [ENT].
5. Use the [←], [→] and [F1]-[F4] keys to select the first parameter to be logged. See Table 3-2 below for a list of the available options.

IMPORTANT: *Only the first parameter logged may be graphically displayed (see Chapter 2, Displaying Data).*

Table 3-2: Measurement Parameter Options

Option Bar Choice	Description
[F1] = VEL	Flow Velocity
[F2] = VOLUM	Volumetric Flow
[F3] = +TOTL	Forward Totalized Volume Flow
[F4] = -TOTL	Reverse Totalized Volume Flow
[→] + [F1] = MDOT	Mass Flow
[→] + [F2] = +MASS	Forward Totalized Mass Flow
[→] + [F3] = -MASS	Reverse Totalized Mass Flow
[→] + [F4] = DIAG	Diagnostic

Creating an ERROR Log (cont.)

In addition, refer to Chapter 3, *Diagnostics*, of the *Service Manual* for a discussion of the many parameters accessible via the DIAG option.

Note: *The units assigned to the parameters in Table 3-2 on page 3-9 are those selected in the User Program (SYSTM submenu).*

6. Use the [←], [→] and [F1]-[F4] keys to select the second parameter to be logged.
7. Use the [←], [→] and [F1]-[F4] keys to select the third parameter to be logged.
 - If you selected a totalized value for display, go to step 8.
 - If you did not, go to step 9.
8. At the *Set Log Totals to 0* prompt, press [F1] to leave the log totals at their present value or press [F2] to reset the log totals to zero. Choosing YES at this prompt only resets the log totals to zero and has no effect on the meter totals.
9. Press [F1] to create a non-circular log or press [F2] to create a circular log.

Log Type

A non-circular log automatically stops when the meter runs out of memory or the specified END TIME is reached. A circular log runs continuously until manually stopped, but only the data from the most recent log cycle is saved. At the start of each cycle, the oldest recorded data is overwritten by the new data from the current cycle.

Caution!

If data from one circular log cycle exceeds the meter's memory capacity, the earliest logged data will be lost.

STARTTIME Prompt

10. Press [F1] to accept the displayed start time or press [F2] to enter a different start time. To start logging immediately, press [F3].
 - If OK was selected, proceed to step 11.
 - If NOW was selected, you have finished setting up the error log. Proceed to *Procedure Options* on the next page.
 - If EDIT was selected, complete the steps listed on the next page.

- STARTTIME Prompt (cont.)
- a. Press [F1]-[F2] to select AM or PM. Then, enter the desired *Hour* (1-12) and press [ENT]. (Entry of a start time earlier than the current time will generate an error message.)
 - b. Enter the desired *Minutes* and press [ENT]. The acceptable range is 0 to 59.
 - c. Enter the desired *Seconds* and press [ENT]. The acceptable range is 0 to 59.

- START DATE Prompt
11. Press [F1] to accept the displayed *Start Date* or press [F2] to enter a different start date. To start logging today, press [F3].
 - If OK or TODAY was selected, you have finished setting up the error log. Proceed to *Procedure Options* below.
 - Otherwise, complete the following steps to *Edit* the Start Date.
 - a. Enter the desired *Year* and press [ENT]. The acceptable range is 0 to 99.
 - b. Use the [←], [→] and [F1]-[F4] keys to select the desired *Month*.
 - c. Enter the desired *Day* and press [ENT]. The acceptable range is 1 to the number of days in the selected month (28, 29, 30 or 31).

- Procedure Options*
- You have completed setting up the error log. Do one of the following:
- Use [↑] and [↓] to review the previous menu prompts.
 - Press [F1]-[F4] to select one of the LOG submenus.
 - To return to the data screen and begin logging data, press the [ENT] key. The * on the locator bar indicates that the Model GC868 is now compiling the specified error log.

The error log will continue to run until it is manually stopped, the meter runs out of memory (for a non-circular log), or the entire 120 records (2 pages x 60 records/page) have been logged.

Chapter 4

Printing Data

- Introduction..... 4-1
- Printing Live Data..... 4-2
- Printing Logs..... 4-5
- Printing a Site File 4-7
- Stop Printing 4-8
- Setting Up a Printer 4-9
- Printing Signal Array Data..... 4-10
- Printing RTD Data..... 4-12

Introduction

The Model GC868 flowmeter has the capability to print any of the data stored in its memory via the built-in RS232 communications port. In order to use the function, the RS232 port must be connected to a printer with a serial port input. A printer with a parallel port input may be used with a third-party serial-to-parallel adapter.

Note: *See Chapter 1, Installation, of the Startup Guide for instructions on wiring the RS232 port. For additional information, refer to Chapter 6, Serial Communications.*

After connecting the Model GC868 to a printer, the *Print Menu* is used to print live or logged data in either numeric or graphical format. In addition, any site files stored in memory may be printed. The *Print Menu* is divided into the following submenus:

- DATA - use to print live data in numeric or graphical format
- LOG - use to print a log file in numeric or graphical format
- PROG - use to print a site file
- STOP - use to terminate any active print jobs
- PRNTR - use to specify the printer currently connected
- SGNLS - use to print transducer signal array data
- RTDs - use to send the numeric point value of a connected RTD device to the RS232 port.

For purposes of this discussion it is assumed that the left pane of the data display screen is active. If the right pane of the data display screen is active, all of the instructions remain the same, except that any references to the [F1]-[F4] keys should be replaced by the [F5]-[F8] keys.

Refer to Figure A-7 on page A-7 and proceed to the desired section for detailed instructions. As an additional aid, the relevant portion of the full menu map is reproduced in each section of this chapter. Any submenu may be followed in the sequence shown or the [↑] and [↓] keys may be used to scroll through the prompts.

Note: *If a printer has not yet been set up, the instructions in “Setting Up a Printer” must be completed before proceeding to any of the other submenus.*

Printing Live Data

Use the DATA submenu to print live measurement data, as it is collected. The data may be printed in either numeric or graphical format, with a user specified time increment.

IMPORTANT: *Make sure that a printer has been properly set up before proceeding with this section.*

To print live measurement data, refer to Figure A-7 on page A-7 and complete the following steps:

1. To access the *Print Menu*, press the [PRNT] key.

Note: *The Print Menu is not protected by the security feature and a password is never required to access this menu.*

2. Press [F1] to select the DATA option.

3. Press [F1] = NUM to print the data in numeric format or press [F2] = PLOT to print the data in graphical format.

- If you press [F1], go to step 4.
- If you press [F2], go to step 8.

Numeric Format

4. Use the [←], [→] and [F1]-[F4] keys to select the first parameter to be printed. See Table 4-1 below for a list of the available options.

Table 4-1: Measurement Parameter Options

Option Bar Choice	Description
[F1] = VEL	Flow Velocity
[F2] = VOLUM	Volumetric Flow
[F3] = +TOTL	Forward Totalized Volume Flow
[F4] = -TOTL	Reverse Totalized Volume Flow
[→] + [F1] = MDOT	Mass Flow
[→] + [F2] = +MASS	Forward Totalized Mass Flow
[→] + [F3] = -MASS	Reverse Totalized Mass Flow
[→] + [F4] = DIAG	Diagnostic

Refer to Chapter 3, *Diagnostics*, of the *Service Manual* for a discussion of the many parameters accessible via the DIAG option.

Note: *The units assigned to the parameters in Table 4-1 above are those selected in the User Program (SYSTM submenu).*

Numeric Format (cont.)

5. Use the [←], [→] and [F1]-[F4] keys to select the second parameter to be printed.
6. Use the [←], [→] and [F1]-[F4] keys to select the third parameter to be printed.
7. Use the [←], [→] and [F1]-[F4] keys to select the desired time increment (the frequency at which measurements are taken). The available options are: 5sec, 10sec, 30sec, 1min, 3min, 6min and 12min.

After the time increment is chosen, the Model GC868 returns to the standard data display screen and continues to take measurements. The live data is printed at the specified time intervals, until a STOP command is issued (see the instructions for the STOP submenu). A portion of a typical printout is shown in Figure 4-1 below.

DATA_DUMP OF (SITE NAME)			
Ch1	Channel	LABEL	Channel Message
Start Date		20	OCT 97
Start Time		03:08:40	PM
HH:MM:SS	CH1 VOLUM ACF/HR	CH1 +TOTL ACF	CH1 SNDSP FT/S
03:08:40 P	686.85	218.92	1039.147
03:08:50 P	666.71	220.83	1039.003
03:09:00 P	662.28	222.70	1039.511
03:09:10 P	675.59	224.84	1039.509
03:09:20 P	669.79	226.71	1039.470
03:09:30 P	675.99	228.58	1039.137
03:09:40 P	670.70	230.45	1039.105
03:09:50 P	684.00	232.57	1039.082
03:10:00 P	680.58	234.46	1039.255
03:10:10 P	678.12	236.34	1038.860
.	.	.	.
.	.	.	.

Figure 4-1: Typical Numeric Printout

Graphical Format

To print live data in graphical format, continue as follows:

8. Use the [←], [→] and [F1]-[F4] keys to select the first parameter to be printed. See Table 4-2 on page 4-4 for a list of the available options.

Graphical Format (cont.)

Table 4-2: Measurement Parameter Options

Option Bar Choice	Description
[F1] = VEL	Flow Velocity
[F2] = VOLUM	Volumetric Flow
[F3] = +TOTL	Forward Totalized Volume Flow
[F4] = -TOTL	Reverse Totalized Volume Flow
[→] + [F1] = MDOT	Mass Flow
[→] + [F2] = +MASS	Forward Totalized Mass Flow
[→] + [F3] = -MASS	Reverse Totalized Mass Flow
[→] + [F4] = DIAG	Diagnostic

Refer to Chapter 3, *Diagnostics*, of the *Service Manual* for a discussion of the many parameters accessible via the DIAG option.

Note: *The units assigned to the parameters in Table 4-2 above are those selected in the User Program (SYSTM submenu).*

9. Enter the desired maximum value for the Y (vertical) axis and press [ENT].

Note: *Enter a Y AXIS MAX value that is larger than the largest expected measurement value.*

10. At the *Y Range* prompt, press [F1] to show only the positive Y axis or press [F2] to display both the positive and negative y axis.

11. Use the [←], [→] and [F1]-[F4] keys to select the desired *Time Increment* (the frequency at which measurements are taken). The available options are: 5sec, 10sec, 30sec, 1min, 3min, 6min and 12min.

After the time increment is chosen, the Model GC868 returns to the standard data display screen and continues to take measurements. The live data is printed at the specified time intervals, until a STOP command is issued (see the instructions for the STOP submenu). A portion of a typical printout is shown in Figure 4-2 below.

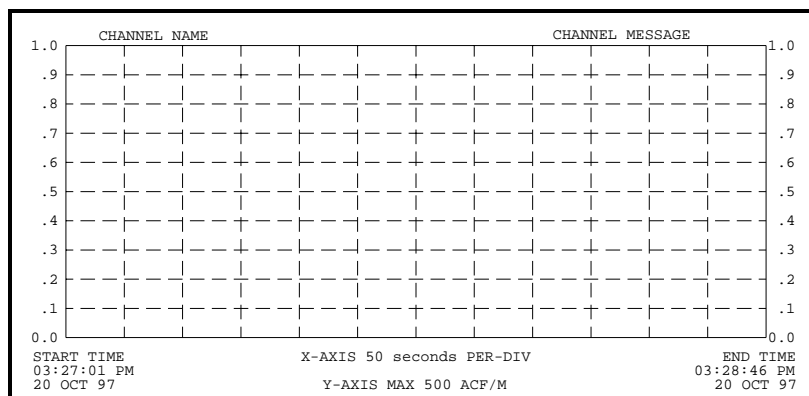

Figure 4-2: Typical Graphical Printout

Printing Logs

Use the LOG submenu to print logged measurement data, from a log file in the meter's memory. The data may be printed in either numeric or graphical format, with a user specified time increment.

IMPORTANT: *Make sure that a printer has been properly set up before proceeding with this section.*

To print logged measurement data, refer to Figure A-5 on page A-5 and complete the following steps:

1. To access the *Print Menu*, press the [PRNT] key.

Note: *The Print Menu is not protected by the security feature and a password is never required to access this menu.*

2. Press [F2] = LOG.

3. At the *Format* prompt, press [F1] to print the log in numeric format or press [F2] to print the log in graphical format.

4. Use the [←], [→] and [F1]-[F4] keys to select a log file to print.

Note: *At the NAME prompt, the option bar shows the names of all completed or active log files currently stored in memory. If an active log is selected for printing, only the data already accumulated at the time of the print command will be printed.*

5. Enter the number of the *First Page* of the log to print and press [ENT]. (This prompt does not appear if the log file is only one page long.)

6. Enter the total number of log *pages* to print and press [ENT]. (This prompt does not appear if the log file is only one page long.)

- If you chose [F1] (Numeric) at step 3, see the section below.
- If you chose [F2] (Graphic) at step 3, go to the next page.

Numeric Format

After the numeric format (and starting page and number of pages, if applicable) is chosen, the Model GC868 returns to the standard data display screen and begins printing the log file. The printout continues until the entire log has been printed or until a STOP command is issued (see the instructions for the STOP submenu). A portion of a typical printout is shown in Figure 4-3 below.

```

LOG DUMP
LOG NAME   Page# 1

LOG MESSAGE

Start Date   09 SEP 97
Start Time   11:50:43 AM
End Date     09 SEP 97
End Time     11:54:45 PM

                Ch1      Ch1      Ch2
                VOLUM    +TOTL    SNDSP
HH:MM:SS     ACF/HR    ACF      FT/S
11:50:45 A    686.85     218.92   1039.147
11:50:55 A    666.71     220.83   1039.003
11:51:05 A    662.28     222.70   1039.511
11:51:15 A    685.58     224.84   1039.500

```

Figure 4-3: Typical Numeric Printout

Graphical Format

After the graphical format (and starting page and number of pages, if applicable) is chosen, complete the following additional steps:

- 7. Enter the desired maximum value for the Y (vertical) axis and press [ENT].

Note: Enter a Y AXIS MAX value that is larger than the largest logged measurement value.

- 8. At the Y Range prompt, press [F1] to show only the positive Y axis or press [F2] to display both the positive and negative y axis.

The Model GC868 returns to the standard data display screen and begins printing the log file. The printout continues until the entire log has been printed or until a STOP command is issued (see the instructions for the STOP submenu). A portion of a typical printout is shown in Figure 4-4 below.

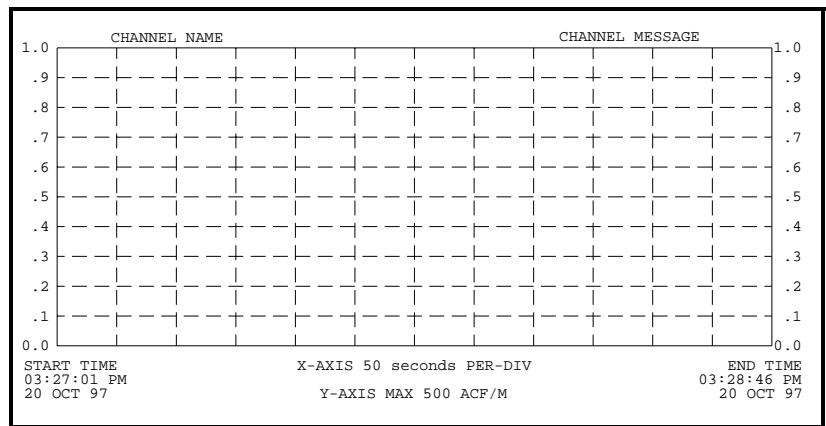

Figure 4-4: Typical Graphical Printout

Printing a Site File

Use the PROG submenu to print the data in a site file that was set up and saved as described in Chapter 1, *Programming Site Data*. To print a site file, refer to Figure A-7 on page A-7 and complete the following steps:

IMPORTANT: *Make sure that a printer has been properly set up before proceeding with this section.*

1. To access the *Print Menu*, press the [PRNT] key.

Note: *The Print Menu is not protected by the security feature and a password is never required to access this menu.*

2. Press [F3] = PROG.

3. Use the [←], [→] and [F1]-[F4] keys to select the desired *Site File* to print.

Note: *All site files currently in memory appear on the option bar. The active site file is always listed as the first choice (Work).*

The Model GC868 returns to the standard data display screen and generates a site file printout similar to the one shown in Figure 4-5 below. The printout continues until the entire file has been printed or until a STOP command is issued (see the instructions for the STOP submenu on the next page).

```

PROGRAM PARAMETERS of SITE NAME
Model GX868G3G
With 1K FIFO and 1113 receiver board
At 9:54:39 AM on 11 FEB 99

CHAN ACTIVE PARAMETERS

Site status          Burst
Skon/measure mode   Skon Only

CHAN SYSTEM PARAMETERS

Ch1 Channel LABEL Channel MESSAGE
Equation             Standard Equation
Volumetric Units    Thousands ACF
Volumetric Time     /min
VOL Decimal Digits  0
Totalizer Units     Actual cubic ft
TOT Decimal Digits  0
Mass Flow Units     Pounds
Mass Flow Time      /sec
MDOT Decimal Digits 0
Mass Units          Pounds
Mass Decimal Digits 0

PIPE PARAMETERS:

Transducer number   81
Pipe OD             12.000 inches
Pipe Wall           0.200 inches

```

Figure 4-5: Typical Site File Printout

Stop Printing

Use the STOP submenu to terminate the printing of live, logged or site data. To stop any active printing activity, see Figure A-7 on page A-7 of Appendix A, *Menu Maps*, and complete the following steps:

IMPORTANT: *Make sure that a printer has been properly set up before proceeding with this section.*

1. To access the *Print Menu*, press the [PRNT] key.

Note: *The Print Menu is not protected by the security feature and a password is never required to access this menu.*

2. Press [F4] = STOP.

3. Press [F1] to continue printing or press [F2] to *Stop* the currently active printing job.

Note: *After the STOP command has been issued, the printer will complete the printing of any data already in the printer buffer. Either wait for the printer to finish or turn the printer off to empty the buffer immediately.*

The Model GC868 returns to the standard data display screen and normal measurement taking.

Setting Up a Printer

Use the PRNTR submenu to specify the type of printer connected to the Model GC868. To set up a printer, refer to Figure A-7 on page A-7 and complete the following steps:

IMPORTANT: *A printer must be properly set up before proceeding to any of the other sections in this chapter*

1. To access the *Print Menu*, press the [PRNT] key.

Note: *The Print Menu is not protected by the security feature and a password is never required to access this menu.*

2. Press the [←] or [→] key to display the option bar shown, and then press [F1] to select the PRNTR submenu.
3. Use the [←], [→] and [F1]-[F4] keys to select the desired *Printer Type*. See Table 4-3 below for a complete list of the available options.

Note: *For compatibility with the Model GC868, the printer must have an RS232 serial interface. To use a printer with a parallel interface, a serial-to-parallel adapter must be used.*

Table 4-3: Available Printer Options

Key(s)	Printer Type	Description
[F1]	DP411	Seiko Model DPU-411 Type II
[F2]	XTECH	Extech Mini Serial Printer 42
[F3]	EPSON	Epson or Epson-compatible
[F4]	KODAK	Kodak Diconix 150 Plus
[→]+[F1]	SP401	Syntest SP-401

After the desired printer type has been selected, the meter returns to the standard data display screen and normal measurement taking.

Printing Signal Array Data

Use the SGNLS submenu to print signal array data, to help diagnose certain problems. To print the signal data, see Figure A-7 on page A-7 and complete the following steps:

IMPORTANT: *Make sure that a printer has been properly set up before proceeding with this section.*

1. To access the *Print Menu*, press the [PRNT] key.

Note: *The Print Menu is not protected by the security feature and a password is never required to access this menu.*

2. Press the [←] or [→] key to display the option bar shown, and then press [F2] to select the SGNLS submenu.

3. Press the [F1]-[F3] keys to select the desired *Signal Array* data to print. To abort the procedure, press the [EXIT] key.

Note: *The SIGNAL option causes the raw signal array data to print, while the CROSS option causes the cross-correlation data to print. The BOTH option prints both sets of data.*

After the desired print selection has been made, the Model GC868 returns to the standard data display screen and normal measurement taking. The specified signal array data is printed continuously, until it is manually stopped. To terminate signal array printing, use the STOP submenu, as described earlier in this chapter. A portion of a typical printout is shown in Figure 4-6 below.

CH1	SKAN	SIGNAL
0	0	0
1	0	0
2	0	0
.		
.		
.		
757	40	44
758	41	45
759	40	42
760	34	34
761	32	34
762	36	38
763	36	36
.		
.		
.		

Figure 4-6: A Typical Signal Array Printout

Printing Signal Array Data (cont.)

The data printed via the SIGNAL submenu consists of 1024 lines, each of which lists the following three values:

- **Index** - this is the printout line number, which locates the data point within the complete body of data.
- **Upstream** - this is the amplitude of the signal from the upstream transducer at the listed index number.
- **Downstream** - this is the amplitude of the signal from the downstream transducer at the listed index number.

Note: *The printouts generated from the CROSS and BOTH submenus will appear after the SIGNAL printout, as separate listings.*

The data printed in this array permits a comparison of the relative signal strengths of the upstream and downstream transducers, which are used to calculate a single flow measurement.

Printing RTD Data

Use the RTDs submenu to send the numeric point value of a connected RTD device to the RS232 port for display on a terminal or RS232 printer. By viewing the point value of the meter at a given temperature, you can calculate the points at the Set Temperature, and the slope of the RTD input in points/degree. (See Chapter 1, *Calibration*, of the *Service Manual* for more details.)

1. To access the *Print Menu*, press the [PRNT] key.

Note: *The Print Menu is not protected by the security feature and a password is never required to access this menu.*

2. Press the [←] or [→] key to display the option bar shown, and then press [F3] to select the RTDs submenu.
3. At the Dump RTD Data prompt, press [F1] to leave the PRINT menu without dumping data, or [F2] to send the RTD data to the RS232 port.

After the selection has been made, the Model GC868 returns to the standard data display screen and normal measurement taking. If you have selected YES at the DUMP RTD DATA prompt, the meter continues to send data until you reenter the PRINT menu and select the STOP option.

Chapter 5

Clearing Data

Introduction.....	5-1
Reset Totals.....	5-2
Deleting Site Files.....	5-3
Deleting Log Files.....	5-4

Introduction

This chapter explains how to purge the Model GC868's memory of various measurement totals and/or files. The *Clear Menu*, which is accessed by pressing the [CLR] key on the keypad, is divided into three submenus:

- TOTAL - used to reset totalized measurement values
- SITE - used to remove site parameter files from memory
- LOG - used to clear log files from memory.

Note: *For detailed information on creating a log file, see Chapter 3, Logging Data. For detailed information on creating a site file and for setting up the stopwatch totalizer, see Chapter 1, Programming Site Data.*

For purposes of this discussion it is assumed that the left pane of the data display screen is active. If the right pane of the data display screen is active, all of the instructions remain the same, except that any references to the [F1]-[F4] keys should be replaced by the [F5]-[F8] keys.

IMPORTANT: *None of the clearing procedures available via the Clear Menu can be undone. Be very sure that the exact consequences of a selected option are thoroughly understood before proceeding.*

Refer to Figure A-8 on page A-8 and proceed to the desired section for detailed instructions. Each submenu may be followed in the sequence shown or the [↑] and [↓] keys may be used to scroll through the prompts.

Reset Totals

The TOTAL submenu permits the user to reset volumetric totals to zero and to reset the stopwatch totalizer. Press the appropriate side of the [SCREEN] key to activate the desired pane of the display screen, and complete the following steps:

1. To access the *Clear Menu*, press the [CLR] key.
 - a. If you have activated the security feature (see Chapter 1, *Programming Site Data*, page 1-50 for details), enter the assigned password and press [ENT].
2. Press [F1] = TOTAL.
3. Press [F1] to abort the procedure or press [F2] to clear all volumetric totals and reset the stopwatch totalizer. In either case, the initial *Clear Menu* prompt returns.

Procedure Options

Do one of the following:

- Press [F1]-[F3] to enter one of the CLR submenus.
- Press the [EXIT] key to return to the data measurement display.

Deleting Site Files

Use the SITE submenu to clear site files from the GC868's memory. Use the [SCREEN] key to activate the desired display pane, and complete the following steps:

1. To access the *Clear Menu*, press the [CLR] key.
 - a. If you have activated the security feature (see Chapter 1, *Programming Site Data*, page 1-50 for details), enter the assigned password and press [ENT].
2. Press [F2] = SITE.
3. At the *Site Name* prompt, use the [←], [→] and [F1]-[F4] keys to select a site file for deletion. To leave the SITE submenu, press the [EXIT] key.

Note: *At the Site Name prompt, the option bar shows the names of all site files currently stored in memory.*

4. Press [F1] to abort the procedure or press [F2] to *Clear* the specified site file. If any site files remain in memory, the *Site Name* prompt repeats.

When all of the stored site files have been cleared or the [EXIT] key has been pressed at the SITE NAME prompt, the programming sequence resumes at this point.

Procedure Options

Do one of the following:

- Press [F1]-[F3] to enter one of the CLR submenus.
- Press the [EXIT] key to return to the data measurement display.

Deleting Log Files

Use the LOG submenu to clear log files from the Model GC868's memory. Press the appropriate side of the [SCREEN] key to activate the desired pane of the data display screen, and complete the following steps:

1. To access the *Clear Menu*, press the [CLR] key.
 - a. If you have activated the security feature (see Chapter 1, *Programming Site Data*, page 1-50 for details), enter the assigned password and press [ENT].
2. Press [F3] = LOG.
3. At the *Name* prompt, the option bar shows the names of all log files currently stored in memory. Use the [←], [→] and [F1]-[F4] keys to select a log file for deletion. To leave the LOG submenu, press the [EXIT] key.
4. Press [F1] to abort the procedure or press [F2] to *Clear* the specified log file. If any log files remain in memory, the *Name* prompt repeats.

When all of the stored log files have been cleared or the [EXIT] key has been pressed at the *Name* prompt, the programming sequence resumes at this point.

Procedure Options

Do one of the following:

- Press [F1]-[F3] to enter one of the CLR submenus.
- Press the [EXIT] key to return to the data measurement display.

Chapter 6

Serial Communications

Introduction.....	6-1
Wiring the RS232 Interface	6-1
Checking the GC868 Baud Rate	6-2
Setting Up the Terminal Software.....	6-2
The Optional RS485 Serial Interface	6-4
Setting Up an Ethernet Connection	6-9
Setting Up a MODBUS/TCP Connection.....	6-10

Introduction

The Model GC868 flowmeter is equipped with a standard RS232 serial interface. By using this interface, any log files stored in the GC868's memory may be easily uploaded to a personal computer. In order to accomplish this, the following steps must be completed:

- Connect the GC868 to the personal computer
- Check the GC868 baud rate setting
- Set up the personal computer's terminal software
- Transfer the log files to the personal computer.

Wiring the RS232 Interface

The first step is to connect the built-in RS232 port in the GC868 to one of the serial ports (COM1 or COM2) on the personal computer. Table 6-1 below lists the standard cables available from the factory for this purpose.

Table 6-1: GE Serial Cables

Part Number	PC Connector	GC868 Connector
704-659	DB25 Male	Flying Leads (5)
704-660	DB9 Male	Flying Leads (5)
704-661	DB25 Female	Flying Leads (5)
704-662	DB9 Female	Flying Leads (5)

Each of the cables listed in Table 6-1 above is available in several standard lengths. However, a user-supplied cable may be used, if preferred. In either case, wire the GC868 end of the serial cable in accordance with the pin designations listed in Table 6-2 below.

Table 6-2: RS232 Pin Connections

GC868 Pin #	GE Cable Color	DB25 Cable Pin #	DB9 Cable Pin #
1 (RTN)	Green	7	5
2 (TX)	Black	3	2
3 (RX)	Red	2	3
4 (DTR)	White	20	4
5 (CTS)	Yellow	5	8

Note: For serial communications between a single GC868 and a single personal computer, no connections are required to pins 4 and 5 of the GC868's serial connector. However, these pins should be jumpered together to ensure proper operation.

Checking the GC868 Baud Rate

For successful serial communications, the GC868 and the personal computer must be set up to send/receive data at the same speed. To check the *baud rate* setting of the GC868, proceed as follows:

Access the *User Program*, by pressing the [PROG] key on the keypad. The standard measurement mode screen is replaced by the following initial programming mode screen:

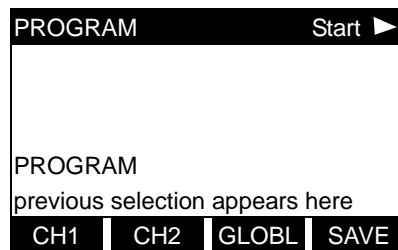

Press the [F3] key to select the GLOBL menu.

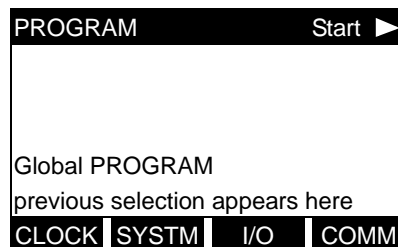

Press the [F4] key to select the COMM submenu.

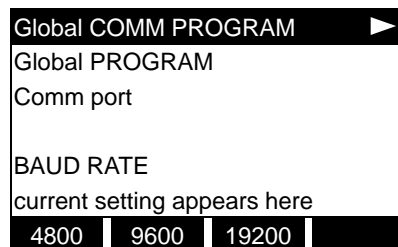

To change the baud rate, press the [→] key until the desired baud rate appears on the option bar, and then press the appropriate [F \times] function key.

The available rates are 300, 600, 1200, 2400, 4800, 9600 and 19200 baud. After verifying or changing the baud rate setting, press the [EXIT] key three times to return to standard measurement mode.

Note: Refer to Chapter 1, Programming Site Data, for a detailed description of using the COMM submenu.

Setting Up the Terminal Software

Specific instructions are given in this manual for communicating with personal computers running under the Windows 9X/NT operating systems.

Note: For computers operating under other operating systems, contact the factory for assistance or consult the operating system manual supplied with the computer.

Windows 9X/NT Systems

Windows 9X/NT systems use a program called *Hyperterminal* to access the serial ports. To set up serial communications with a personal computer running under Windows 95, Windows 98 or Windows NT, make sure the GC868 is powered on and complete the following steps:

1. From the Windows START menu, select PROGRAMS>ACCESSORIES>HYPERTERMINAL>HYPERTERMINAL.
2. The NEW CONNECTION window should appear (if it does not, select it from the FILE menu). After entering the desired CONNECTION NAME and selecting an ICON, click on OK.
3. When the CONNECT TO window appears, select the serial communications port (COM1 or COM2) to which the GC868 is connected and click on OK.
4. When the COMx PROPERTIES window appears, make sure the settings are as follows:
 - Bits per Second: 9600 (must match the GC868 setting)
 - Data Bits: 8
 - Parity: None
 - Stop Bits: 1
 - Flow Control: Xon/Xoff

After making any necessary changes, click on OK.

5. Open the TRANSFER menu and select CAPTURE TEXT. Enter the desired DRIVE:\DIRECTORY\FILENAME for the file about to be transmitted, and click on OK.
6. From the keypad on the GC868, enter the PRINT menu and select the log file to be uploaded to the computer in numeric format. See Chapter 4, *Printing Data*, for detailed instructions on this procedure.
7. The logged data will begin appearing on the computer screen. When the transfer has been completed, open the TRANSFER menu and select CAPTURE TEXT>STOP. The uploaded file may now be used in any software program, just like any other text file.

Note: *If the RS232 link does not function, switching the leads to pins 2 (TX) and 3 (RX) at the RS232 connector on the meter often solves the problem.*

The Optional RS485 Serial Interface

Although the standard RS232 serial interface included with the Model GC868 is adequate for most applications, GE offers an optional RS485 serial interface upgrade for special situations. The Model GC868 is easily modified to provide RS485 communications, and this section describes the wiring and use of the special RS232 to RS485 converter.

Note: *For compliance with the European Union's Low Voltage Directive (73/23/EEC), this unit requires an external power disconnect device such as a switch or circuit breaker. The disconnect device must be marked as such, clearly visible, directly accessible, and located within 1.8 m (6 ft) of the electronics console.*

Interface Converter Mounting

A special bracket containing the serial interface converter and a three-terminal barrier strip is mounted inside the Model GC868, just below the RS232 terminal block (see Figure 6-1 below). The standard RS232 terminal block is wired to the input of the serial interface converter, and the RS-485 output of the serial interface converter is wired to the barrier strip.

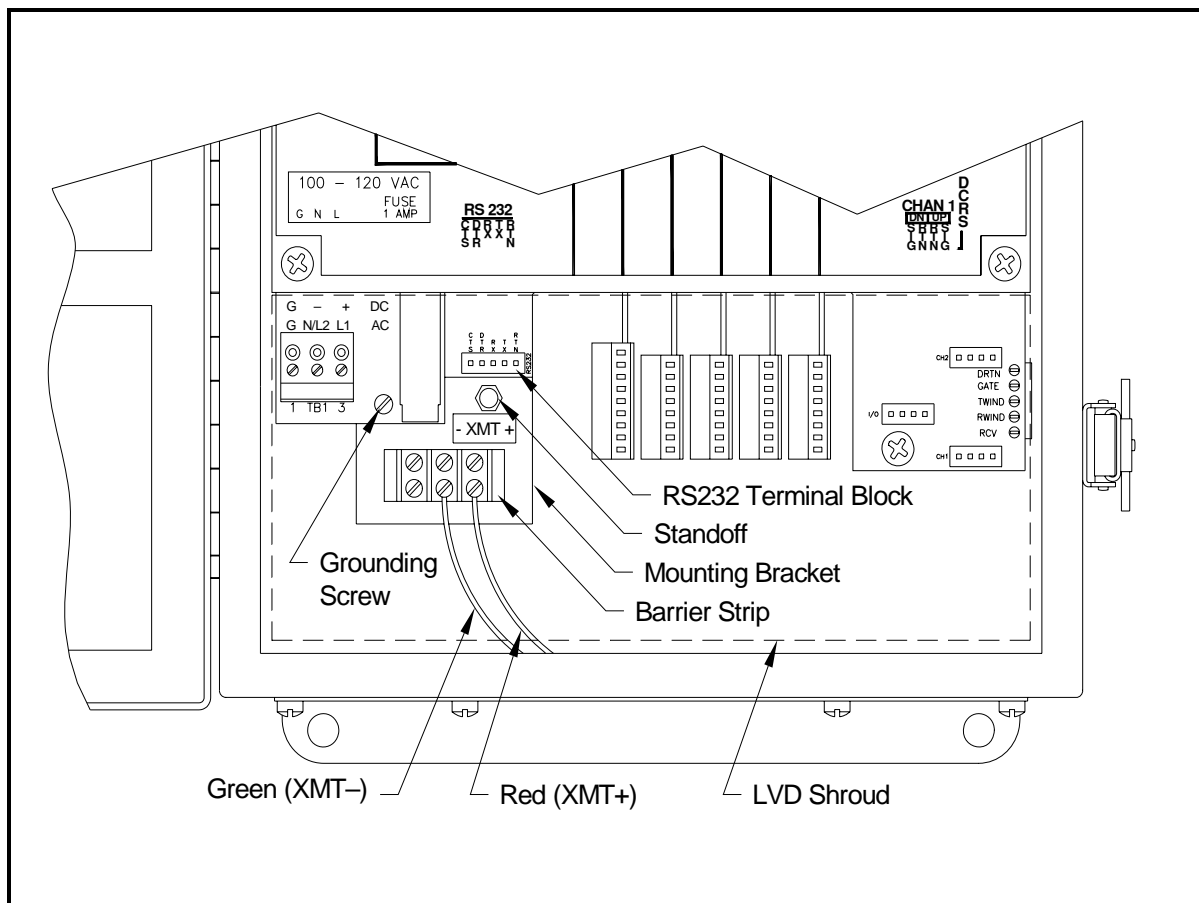

Figure 6-1: Interface Converter Mounting

Point-To-Point Wiring

Standard factory wiring of the RS485 serial interface is configured for point-to-point wiring. That is, a single Model GC868 may be wired directly to a single personal computer. To connect the RS485 serial interface, refer to Figure 6-1 on page 6-4 and complete the following steps:

Note: *For compliance with the European Union's Low Voltage Directive (73/23/EEC), a transparent plastic shroud protects the electrical connections. The shroud must remain in place, except while wiring the unit. Reinstall the shroud after the wiring has been completed.*

1. Disconnect the *main power* to the electronics console and open the cover.

!WARNING!

**Dangerous voltages exist within the electronics console.
Do not perform any wiring operations until the main
power to the unit has been disconnected.**

2. Remove the clear plastic *shroud* that covers the electrical connectors.
3. Using a *twisted-wire pair*, connect the XMT+ terminal of the barrier strip to the T+/R+ terminal of the PC's RS485 adapter and connect the XMT- terminal of the barrier strip to the T-/R- terminal of the PC's RS485 adapter (see the documentation provided with the RS485 adapter for details).

Note: *The XMT+ terminal on the barrier strip is the screw opposite the red wire connection and the XMT- terminal on the barrier strip is the screw opposite the green wire connection.*

4. Reinstall the clear plastic shroud, close the cover to the electronics console and reconnect the main power.

The RS485 serial interface is now ready for point-to-point operation.

Multi-Point Wiring

The standard point-to-point wiring configuration for the serial interface converter may be modified to permit the use of a multi-point wiring arrangement. In a multi-point RS485 system, one flowmeter (the master) is connected to the personal computer, while a number of additional flowmeters (the slaves) are chained together and connected to the master flowmeter. In order to implement such a system, the DIP switch settings inside each serial interface converter must be changed.

IMPORTANT: *The serial interface converter in the last slave unit in the chain should not be reconfigured.*

Reconfiguring a Serial Interface Converter

To reconfigure a serial interface converter for multi-point wiring, complete the following steps:

1. Disconnect the *main power* to the electronics console and open the cover.

!WARNING!

**Dangerous voltages exist within the electronics console.
Do not perform any wiring operations until the main
power to the unit has been disconnected.**

2. Remove the clear plastic *shroud* that covers the electrical connectors.
3. Remove the serial interface converter *mounting bracket* by removing the standoff located just below the RS232 terminal block and the grounding screw to its left (see Figure 6-1 on page 6-4).
4. Loosen the two screws that fasten the DB9 connector to the mounting bracket, and remove the *serial interface converter* from the bracket.
5. Use a small screwdriver to pry open the *plastic case* of the serial interface converter, as shown in Figure 6-2 on page 6-7.

The serial interface converter contains a main printed circuit board and a daughter printed circuit board. The daughter board has a small terminal block attached to it and the main board has a DIP switch (SW1) mounted near the center of the board.

6. Locate the switch assembly on the main board, and move the switch in position 1 from ON to OFF. The standard ON state for this switch is for point-to-point operation, while the OFF state is needed for multi-point operation. See Table 6-3 on page 6-7 for the proper settings of all four switches on the switch assembly.

Reconfiguring a Serial Interface Converter (cont.)

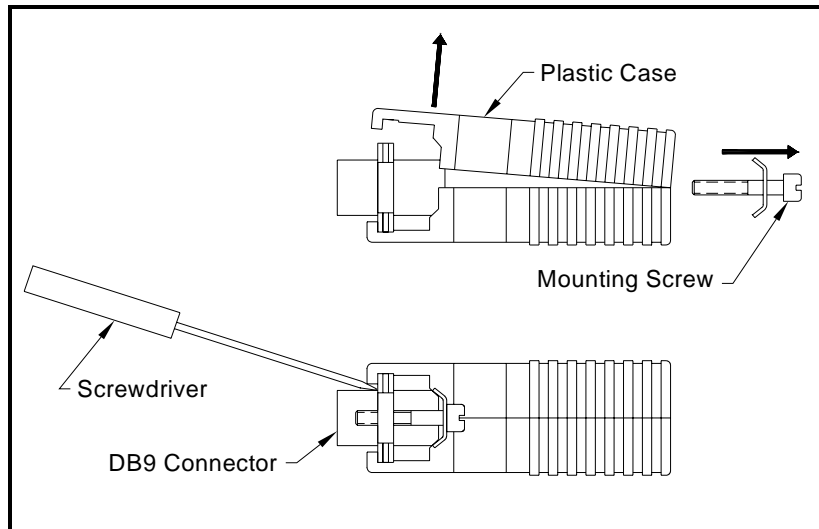

Figure 6-2: Opening the Converter Case

Table 6-3: Switch Assembly Settings

Position #	Point-To-Point	Multi-Point
1	ON	OFF
2	ON	ON
3	ON	ON
4	OFF	OFF

7. Reassemble the serial interface converter and secure it to the mounting bracket with the two mounting screws.
8. Reinstall the mounting bracket into the electronics enclosure and secure it with the standoff and the grounding screw.

Wiring the System

After the serial interface converters have been configured for multi-point operation, the system can be wired.

1. Using *twisted-wire pairs*, connect the XMT+ terminals of all the flowmeters together and connect the XMT– terminals of all the flowmeters together.

IMPORTANT: *Make sure that the flowmeter with the non-modified converter is wired as the last unit in the chain.*

2. Using a *twisted-wire pair*, connect the XMT+ terminal of the barrier strip to the T+/R+ terminal of the PC's RS485 adapter and connect the XMT– terminal of the barrier strip to the T-/R– terminal of the PC's RS485 adapter (see the documentation provided with the RS485 adapter for details).

Note: *The XMT+ terminal on the barrier strip is the screw opposite the red wire connection and the XMT– terminal on the barrier strip is the screw opposite the green wire connection.*

3. Reinstall the clear plastic shroud, close the cover to the electronics console and reconnect the main power.

The RS485 serial interface is now ready for multi-point operation.

Setting Up an Ethernet Connection

A modified GC868 can use the Ethernet interface to communicate with an internal network. An optional Ethernet card with a unique MAC (IP) address (installed only in slots 5 or 6) includes an RJ45 connector. To connect the Ethernet-enabled GC868 to the network, insert the jack of an RJ45 cable into the RJ45 connector, route the cable through the bottom of the GC868, and wire the other end of the cable to the LAN according to the manufacturer's instructions.

To establish Ethernet communications with the GC868, you must install the Ethernet Device Discovery software utility (available with your modified GC868) on a PC connected to the LAN. Once installed and running, the software displays all Ethernet devices currently connected to the subnet. You can identify the GC868 by its MAC address, supplied as part of customer documentation. The default IP Port is 2101.

The default IP addressing for the GC868 is DHCP (dynamic). If you need to assign a static IP address to the GC868, complete the following steps:

IMPORTANT: *To assign a static IP address, the GC868 must be connected to an Ethernet network with a dynamic address assignment mechanism (DHCP) first.*

1. Run Ethernet Device Discovery software, and identify the GC868's current IP address.
2. Open your Internet browser (Internet Explorer, Netscape, or other) and type the GC868 IP address in the Address box.
3. The Connect ME Configuration and Management window opens. Two text boxes ask for the user name and password.
 - a. In the Username text box, type root.
 - b. In the Password text box, type dbps.
4. At the left of the window, click on Network.
5. The IP Settings window opens. In the text boxes for IP Address, Subnet Mask, and Default Gateway, type in the new information.
6. Click Apply. The software applies the new address.

Setting Up a MODBUS/ TCP Connection

A modified GC868 can use the MODBUS/TCP interface to communicate with an internal network. An optional MODBUS/TCP card with a unique MAC (IP) address (installed only in slots 5 or 6) includes an RJ45 connector. To connect the MODBUS/TCP-enabled GC868 to the network, insert the jack of an RJ45 cable into the RJ45 connector, route the cable through the bottom of the GC868, and wire the other end of the cable to the LAN according to the manufacturer's instructions.

To establish MODBUS/TCP communications with the GC868, you must install the Ruiping software utility (available with your modified GC868) on a PC connected to the LAN. Once installed and running, the software displays all Ethernet devices currently connected to the subnet. You can identify the GC868 by its MAC address, supplied as part of customer documentation. The default TCP Port is 502.

The default IP addressing for the GC868 is DHCP (dynamic). If you need to assign a static IP address to the GC868, complete the following steps:

IMPORTANT: *To assign a static IP address, the GC868 must be connected to an Ethernet network with a dynamic address assignment mechanism (DHCP) first.*

1. Run Ruiping software, and identify the GC868's current IP address.

Note: *"Ruiping-e" will return the found IP address as well as the MAC address.*

2. From a DOS command prompt, type: telnet "ip address" 10000

3. The "Welcome to Net+Works Configuration Utility" opens. Type in the login name and password.

a. Login: type root.

b. Password: type Netsilicon.

4. In the Main Menu:

a. Select IP Parameters (1). Enter the desired IP changes and return to the Main Menu.

b. Select Enable DHCP Client (3). Select N (2) to disable, then select 4 for Main Menu.

c. At the Main Menu, select 4 for Quit. Power cycle the GC868 (i.e., turn the meter off and on) to apply the changes.

Appendix A

Menu Maps

- ACTIV, SYSTM and PIPE Menu MapA-1
- CH1/CH2 - I/O and Setup Menu MapA-2
- CH1/CH2 - ADVAN Menu MapA-3
- GLOBL (except I/O), SAVE and RECLL Menu MapA-4
- GLOBL - I/O Menu MapA-5
- DISP Menu MapA-6
- PRNT Menu MapA-7
- LOG and CLR Menu MapsA-8

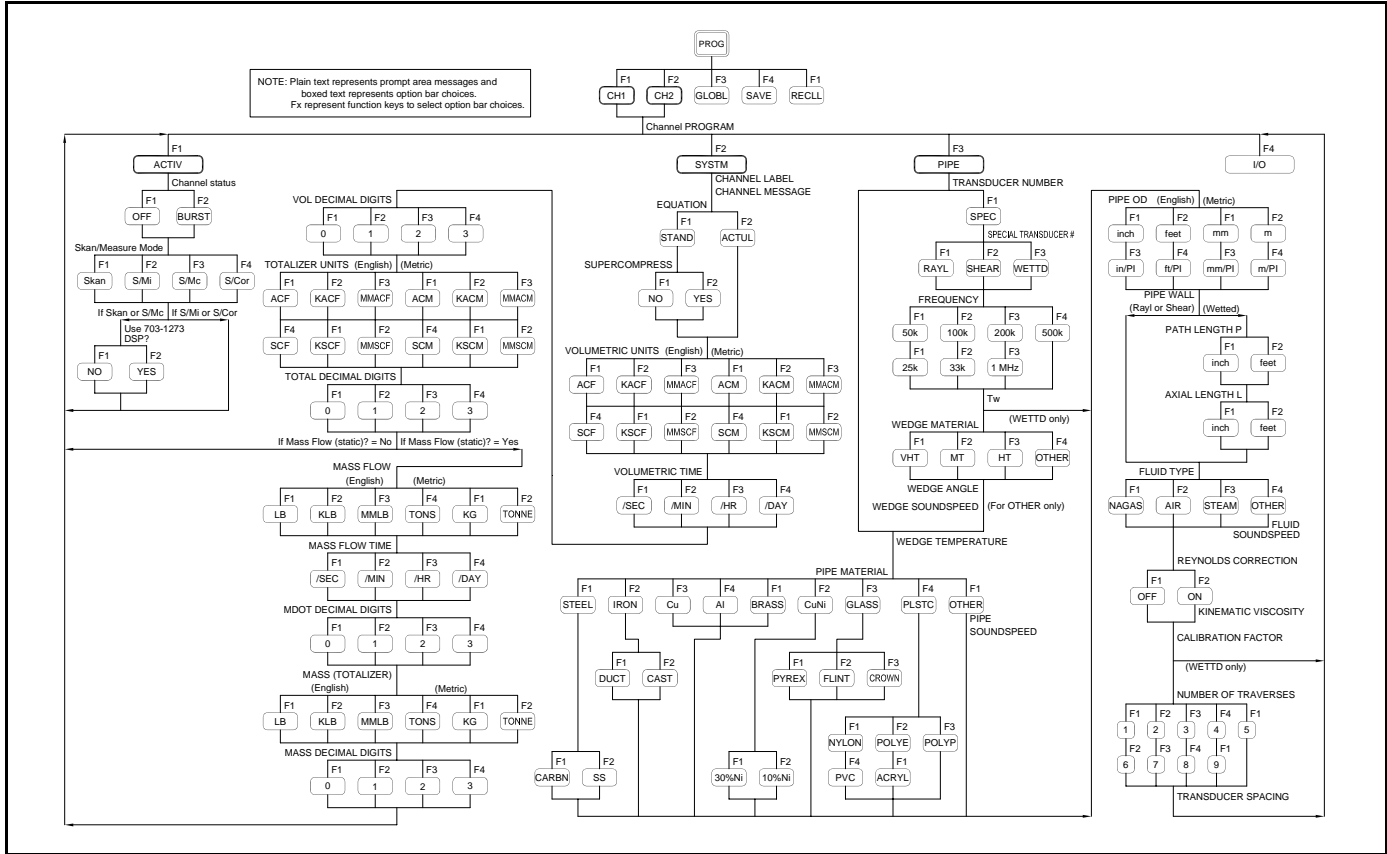

Figure A-1: ACTIV, SYSTEM and PIPE Menu Map

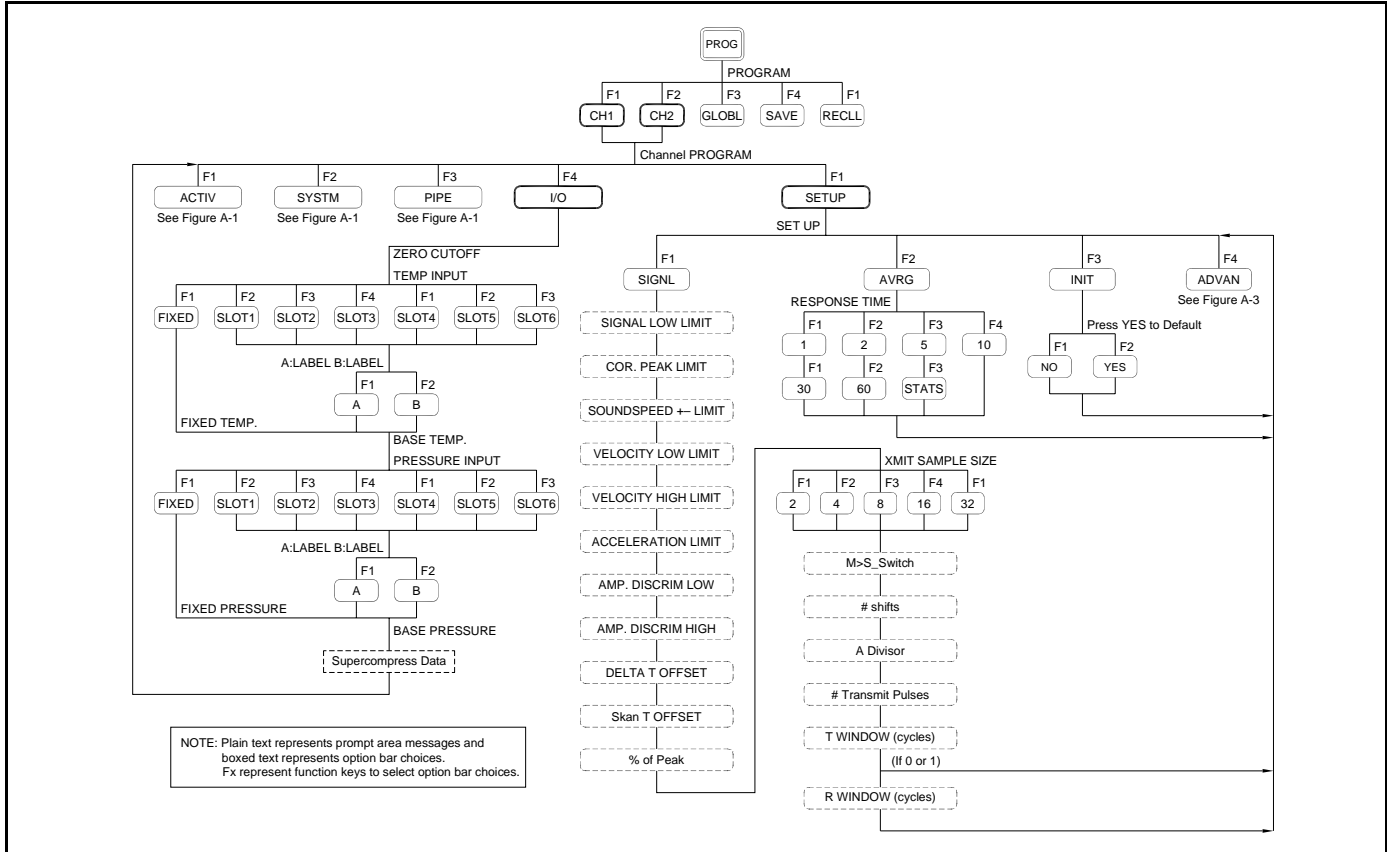

Figure A-2: CH1/CH2 - I/O and Setup Menu Map

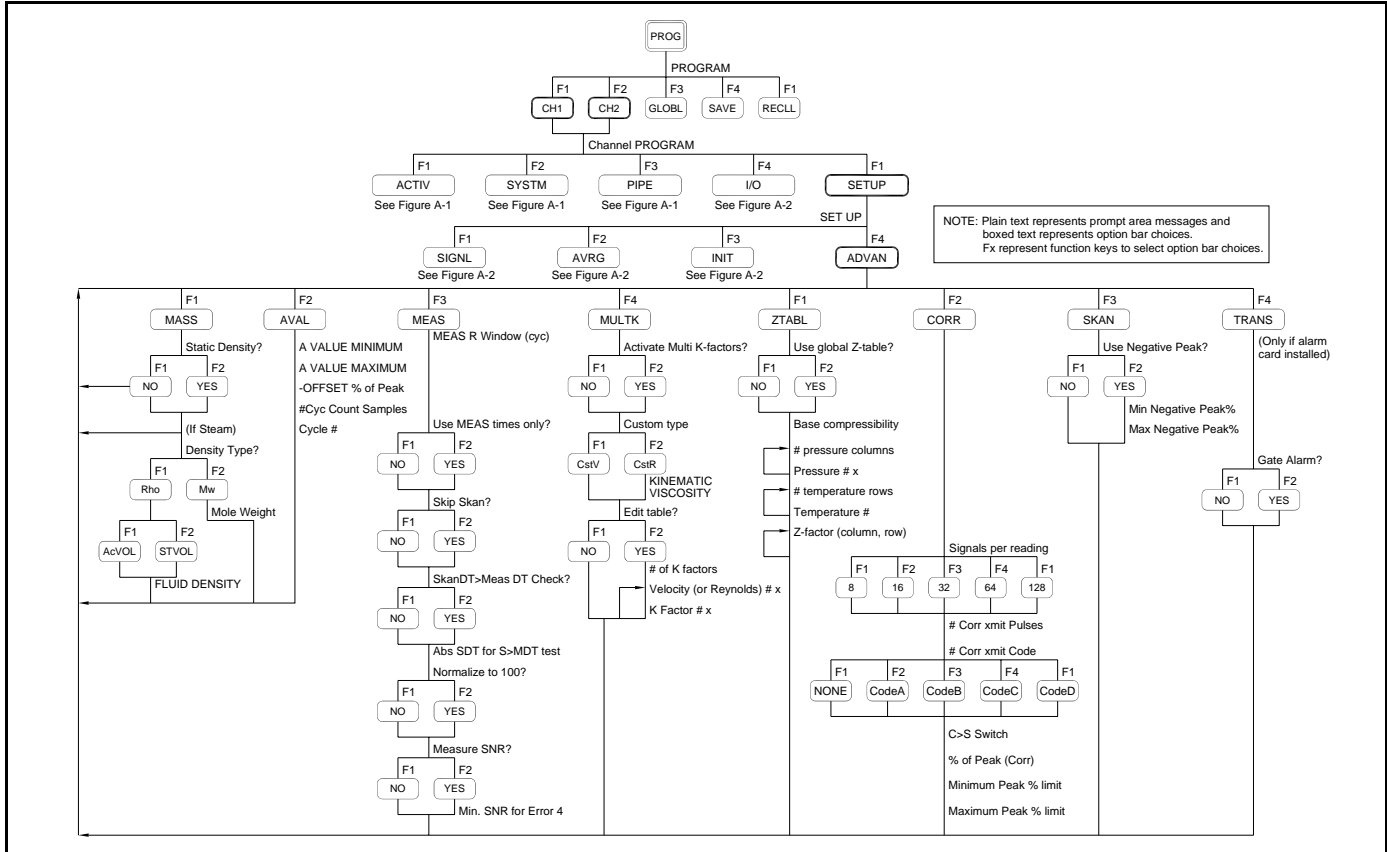

Figure A-3: CH1/CH2 - ADVAN Menu Map

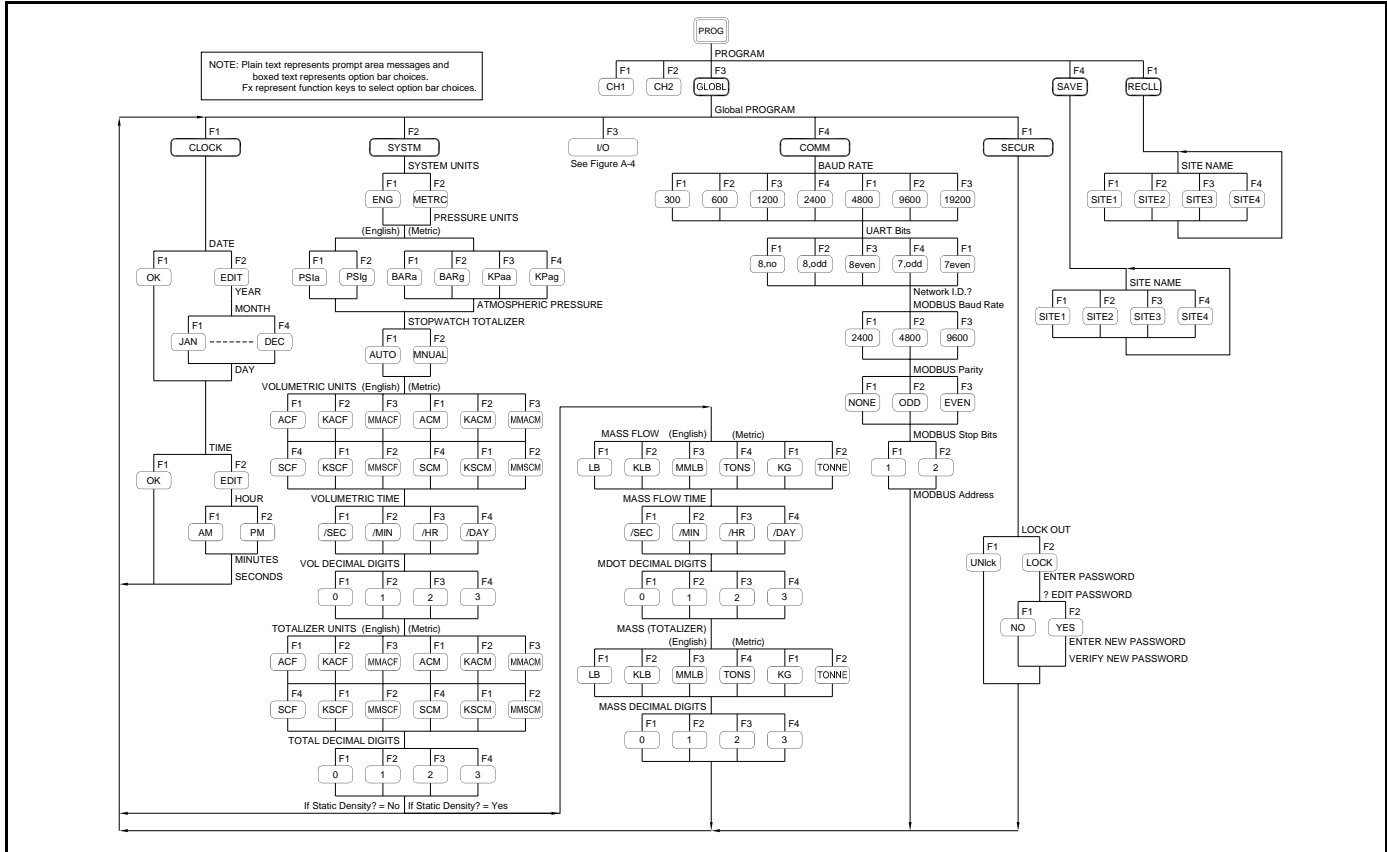

Figure A-4: GLOBAL (except I/O), SAVE and RECALL Menu Map

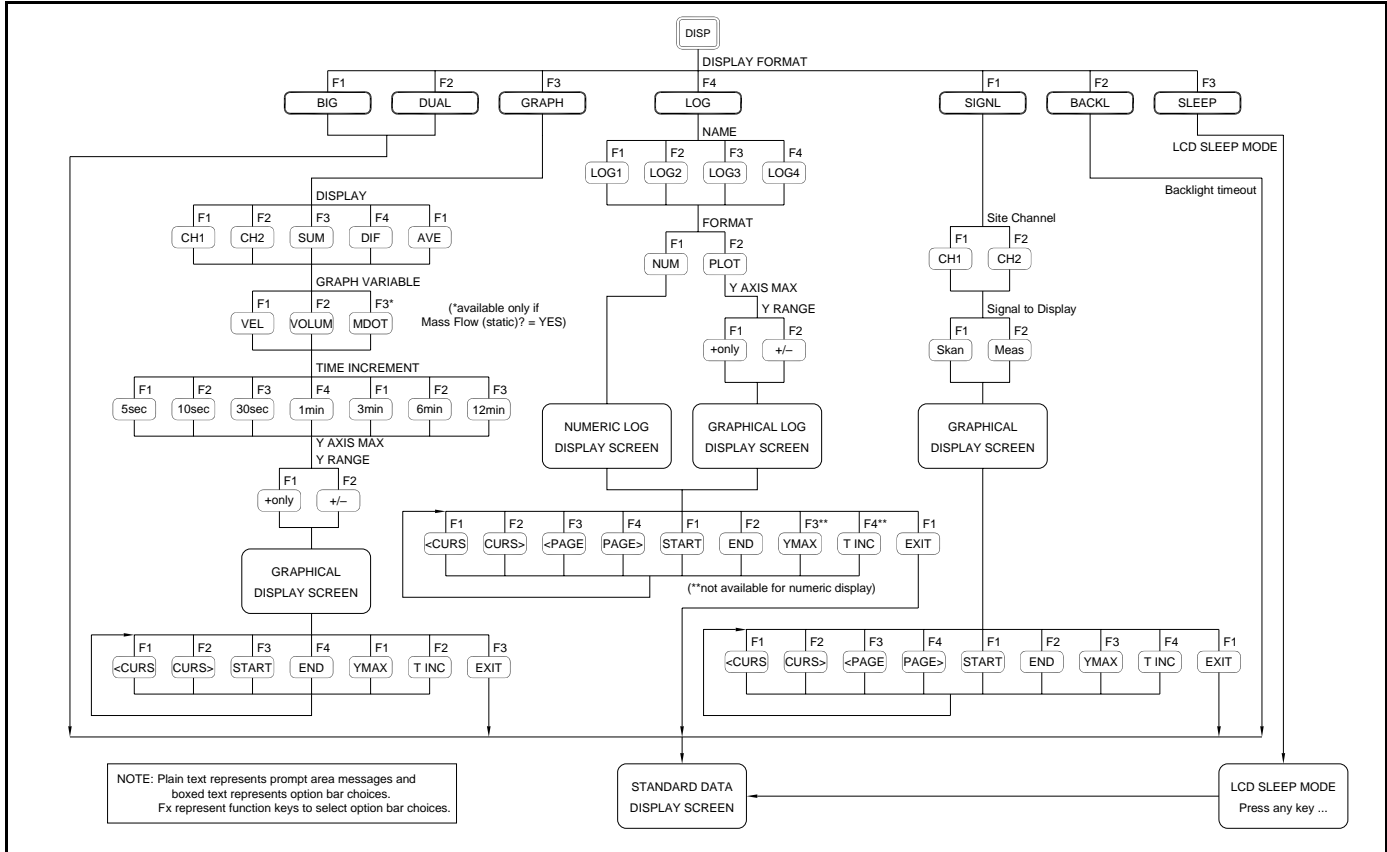

Figure A-6: DISP Menu Map

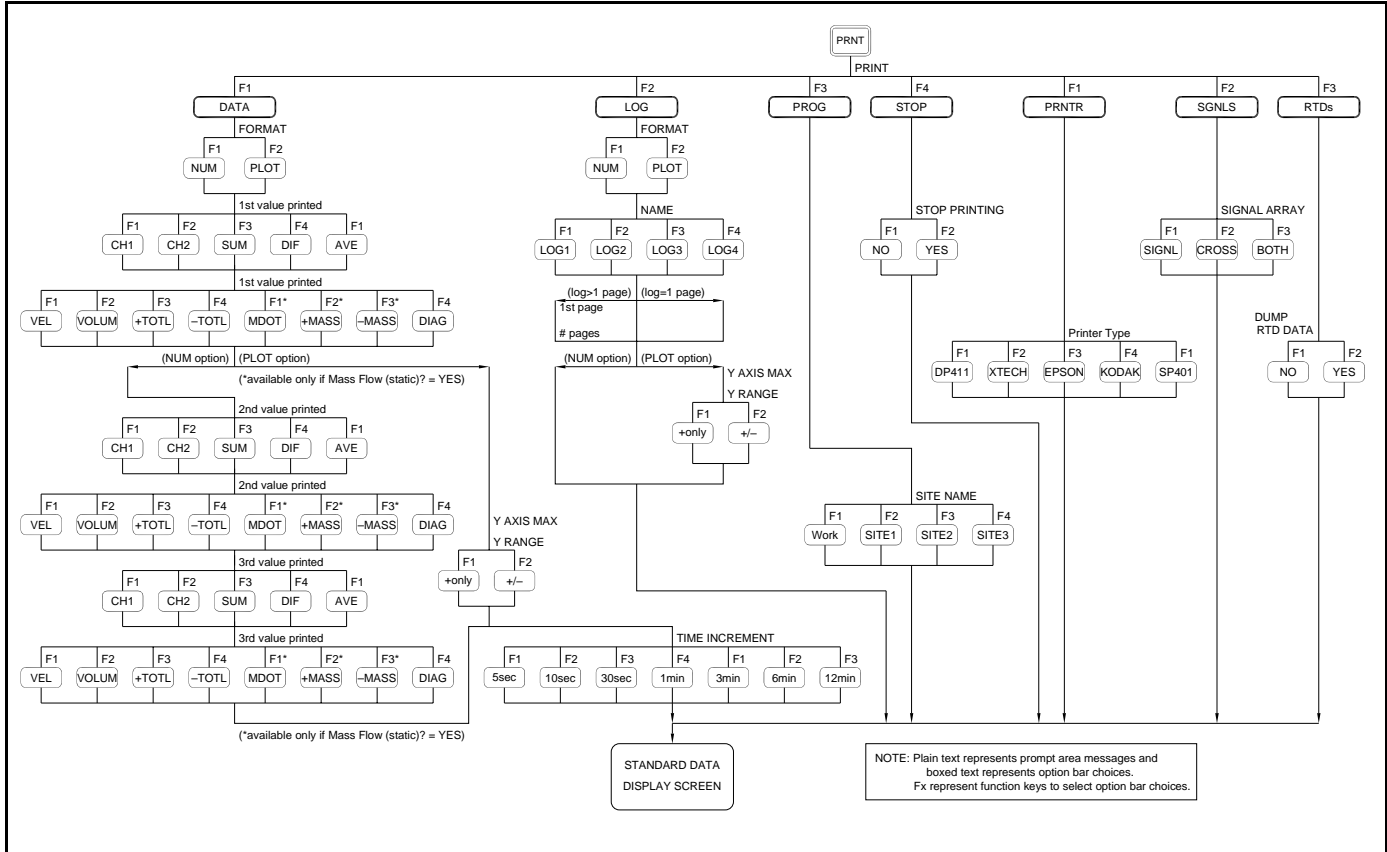

Figure A-7: PRNT Menu Map

STANDARD DATA
DISPLAY SCREEN

NOTE: Plain text represents prompt area messages and
boxed text represents option bar choices.
Fx represent function keys to select option bar choices.

Appendix B

Data Records

Option Cards InstalledB-1

Initial Setup DataB-2

Option Cards Installed

Whenever an option card is installed in one of the Model GC868's expansion slots, record the type of card and any additional setup information in the appropriate row of Table B-1 below.

Table B-1: Option Cards Installed

Slot #	Type of Option Card	Additional Setup Information
0	Analog Outputs (A, B)	
1		
2		
3		
4		
5		
6		

Initial Setup Data

After the Model GC868 flowmeter has been installed, some initial setup data must be entered via the *User Program*, prior to operation. Record that information in Table B-2 below.

Table B-2: Initial Setup Data

General Information					
Model #				Reference	
Software Vers.				Date	
Serial #					
Measurement Method (CH1/CH2-ACTIV)					
Channel 1			Channel 2		
Channel Status	Off	Burst	Channel Status	Off	Burst
Measure Mode	Skon	S/M	Measure Mode	Skon	S/M
Channel Parameters (CH1/CH2-SYSTEM)					
Channel 1			Channel 2		
Channel Label			Channel Label		
Channel Message			Channel Message		
Gas Equation	Standard	Actual	Gas Equation	Standard	Actual
Supercompress?			Supercompress?		
Vol. Units			Vol. Units		
Vol. Time Units			Vol. Time Units		
Vol. Dec. Digits			Vol. Dec. Digits		
Totalizer Units			Totalizer Units		
Tot. Dec. Digits			Tot. Dec. Digits		
If Mass Flow = YES			If Mass Flow = YES		
Mass Flow			Mass Flow		
Mass Flow Time			Mass Flow Time		
MDOT Dec. Dig.			MDOT Dec. Dig.		
Mass (TOT.)			Mass (TOT.)		
Mass Dec. Dig.			Mass Dec. Dig.		
System Parameters (GLOBL)					
System Units	English	Metric	If Static Density? = YES		
Pressure Units			Mass Flow		
Stopwatch Total.	Auto	Manual	Mass Flow Time		
Vol. Units			MDOT Dec. Dig.		
Vol. Time Units			Mass (TOT.)		
Vol. Dec. Digits			Mass Dec. Dig.		
Totalizer Units			COMM Submenu		
Tot. Dec. Digits			Password		
ERROR Submenu			Baud Rate		
Error Handling			UART Bits		
2-Path Error	NO	YES	Network ID		

Table B-2: Initial Setup Data (Continued)
Pipe/Transducer Parameters (CH1/CH2-PIPE)

Channel 1		Channel 2	
Std. Trans. #		Std. Trans. #	
Spec. Trans. #		Spec. Trans. #	
Spec. Trans. Hz		Spec. Trans. Hz	
Spec. Trans. Tw		Spec. Trans. Tw	
Transducer Type	RAYL SHEAR WETTD	Transducer Type	RAYL SHEAR WETTD
Wedge Material		Wedge Material	
Wedge Angle		Wedge Angle	
Wedge Soundspeed		Wedge Soundspeed	
Wedge Temperature		Wedge Temperature	
Pipe Material		Pipe Material	
Pipe O.D.		Pipe O.D.	
Pipe Wall		Pipe Wall	
Path Length (P)		Path Length (P)	
Axial Length (L)		Axial Length (L)	
Fluid Type	NaGas Air Steam Other	Fluid Type	NaGas Air Steam Other
Other/Sndspd		Other/Sndspd	
Reynolds Corr?	Yes No	Reynolds Corr?	Yes No
Kin. Viscosity		Kin. Viscosity	
Cal. Factor		Cal. Factor	
# Traverses		# Traverses	
XDCR Spacing		XDCR Spacing	

Appendix C

Programming with PanaView

- Introduction.....C-1
- Wiring the RS232 InterfaceC-1
- Setting Up the Communications PortC-2
- Adding the GC868.....C-5
- Editing Meter Properties.....C-7
- Changing Meter SettingsC-15

Introduction

The PanaView™ graphical user interface offers interactive communications between Windows-based PCs and GE instruments compatible with the company's IDM protocol, such as the GC868 ultrasonic gas flowmeter. PanaView is compatible with 32-bit Windows operating systems such as Windows 98SE, NT 4.0 (with Service Pack 6), 2000, XP and ME. With PanaView, you can:

- load and save site file data
- create and save graph and log files
- display text output and graphs of live measurement data
- create custom templates for displaying text, graph and log data
- interface with multiple GE instruments.

This document focuses on particular applications suitable for the GC868. For general PanaView applications such as creating graph and log files, displaying live measurement data, and creating custom templates, please refer to the general PanaView *User's Manual* (910-211).

Wiring the RS232 Interface

All IDM-protocol instruments utilize an RS232 interface to communicate with a PC. For details on wiring your RS232 interface, please refer to the *Installation* chapter of your instrument's User's Manual, and to the document *EIA-RS Serial Communications* (916-054).

Setting Up the Communications Port

Use the steps below to establish communications with the GC868.

1. Open the “*New Meter Browser*” window and expand the network tree. Then, highlight the *My Computer(Name)* branch by clicking on it.
2. Pull down the “*Edit*” menu by clicking on it in the menu bar.
3. Click on the “*New*” menu option to select it, and a submenu opens with two choices on it (see Figure C-1 below).

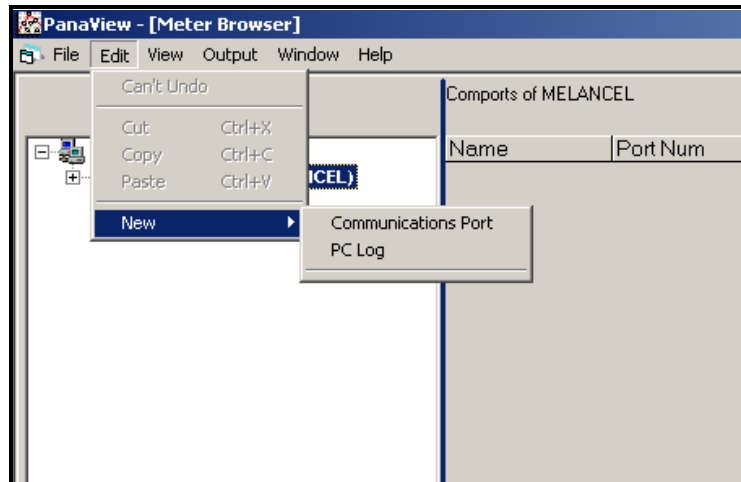

Figure C-1: Edit Menu

Setting Up the Communications Port (cont.)

- Click on the “*Communications Port*” option to select it. The *Setup Communications* screen appears similar to Figure C-2 below.

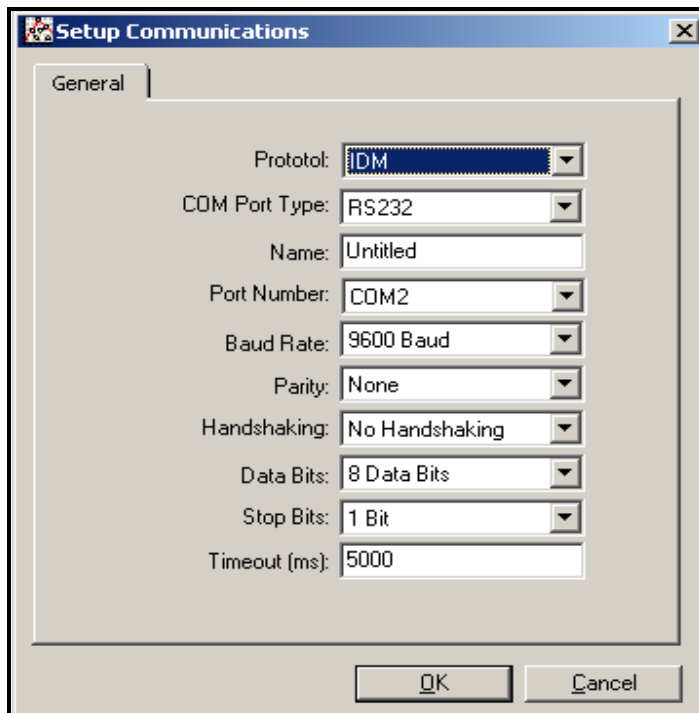

Figure C-2: Setup Communications Screen

- Open the Protocol menu (the first of the drop-down menus) and click on *IDM*.
- Open the COM Port Type menu and click on the desired type (or on *TCP/IP*, if the GC868 is using an Ethernet connection).

Note: *If you select TCP/IP, the menu changes. Proceed to the next page.*

- Select any suitable available baud rate. A baud rate of 19,200 is appropriate for almost all applications. However, if you experience periodic communication reliability problems, you may wish to consider lowering the baud rate on your instrument and in PanaView.

IMPORTANT: *Be sure all the communications port settings match those made in setting up the meter's serial port.*

- Click [OK] to complete data entry.

Setting up Ethernet Communications

If you have selected TCP/IP in step 6 on the previous page, the Setup Communications window appears similar to Figure C-3 below.

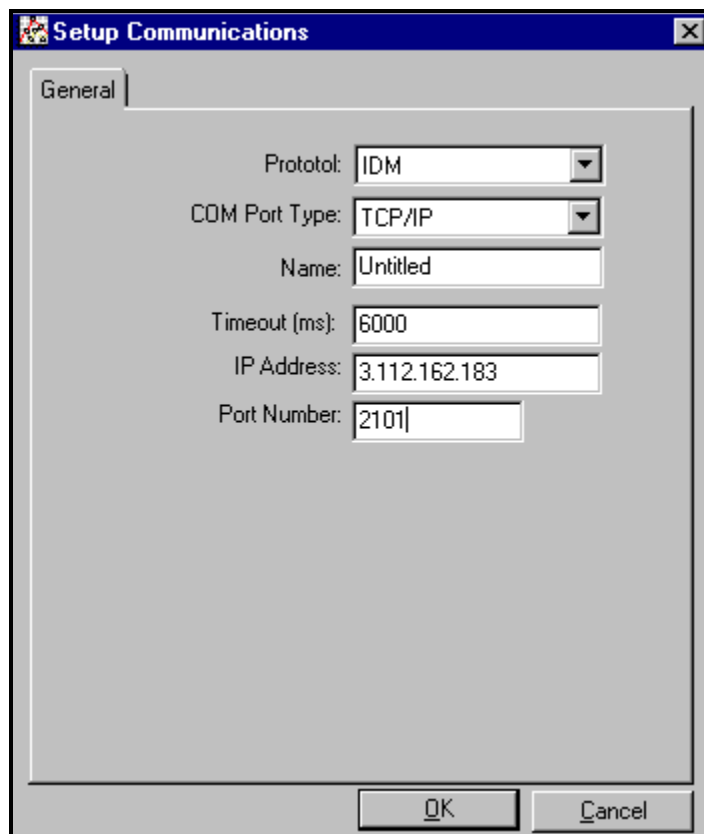

Figure C-3: Setup Communications for TCP/IP

7. Type in the desired *Name* and *Timeout* (in milliseconds).
8. In the *IP Address* text box, enter the IP address. If the IP address is unknown, run the Device Discovery software utility. All units found will be identified by their MAC address and the assigned IP address. In the *Port Number* box, enter 2101 (the default value).
9. Click [OK] to complete data entry.

IMPORTANT: *If you are using Ethernet communications, be sure the GC868 is set up with the default communications parameters: 9600 baud, no parity, no handshaking, 8 data bits and 1 stop bit. The port number must match the "Enable Raw TCP access using TCP Port" assignment shown under the Device Discovery "TCP Server Settings" menu (Configuration>Serial Ports>Port).*

Adding the GC868

To add the GC868 on the IDM-configured communications port, complete the following steps:

1. Highlight the communication port to which the meter will be added by clicking on it, and then open the “*Edit*” menu on the menu bar (if the communication port is not highlighted first, the “*New Meter*” option is not active in the “*Edit*” menu).
2. Click on the “*New*” option in the “*Edit*” menu (see Figure C-4 below).

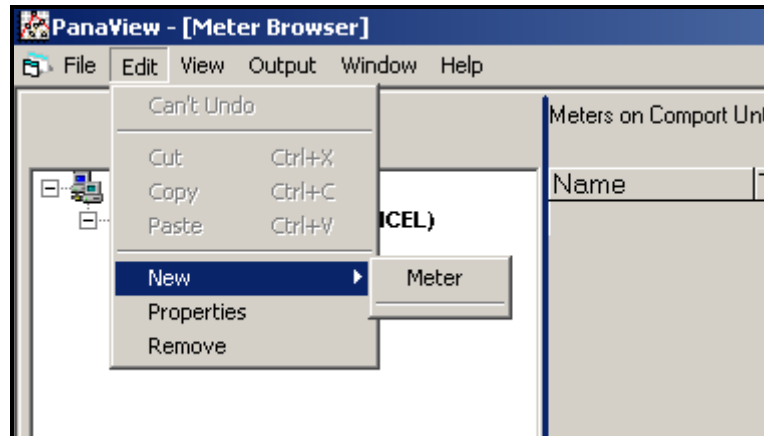

Figure C-4: “*New*” Option in the “*Edit*” Menu

3. After clicking on the “*New*” option, the “*Meter*” menu option appears. Click on this option to select it.
4. The “*New IDM Meter*” screen (shown in Figure C-5 below) opens. Enter the Network ID number for the meter, and click [OK].

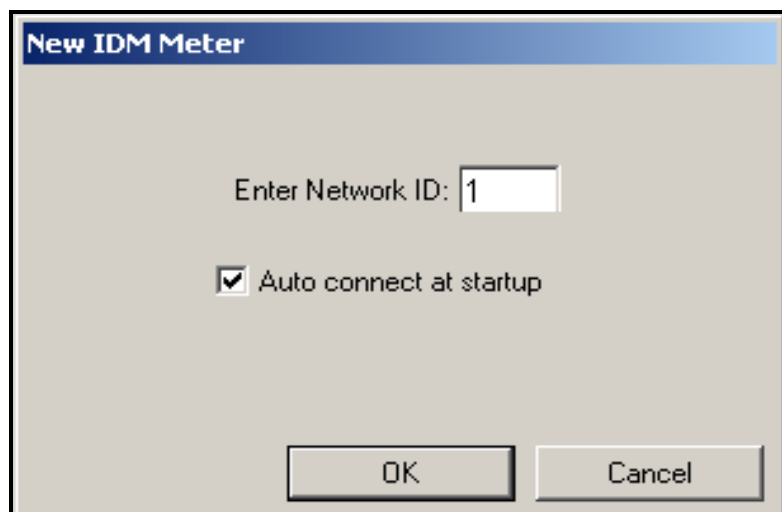

Figure C-5: New IDM Meter Screen

Adding the GC868 (cont.) **IMPORTANT:** *The Network ID number must match the Network ID programmed in the meter's Communications menu.*

If the initialization is successful, the Meter Browser shows a listing similar to Figure C-6 below.

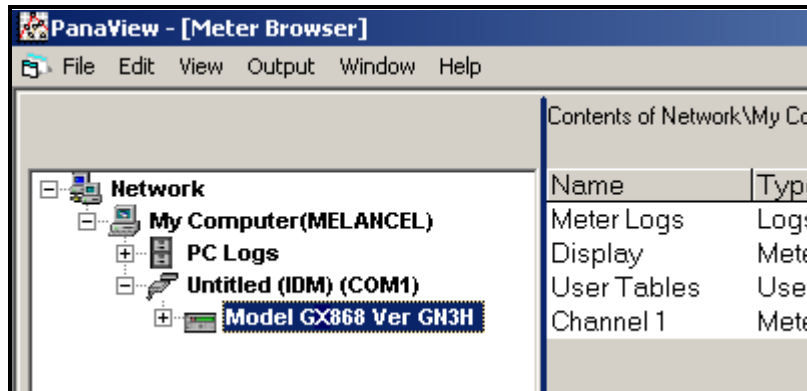

Figure C-6: Updated Network Tree

Note: *The model number and version that appear will vary with your particular meter and software version.*

However, if the settings do not match, or there is some other difficulty, a screen appears similar to Figure C-7 below.

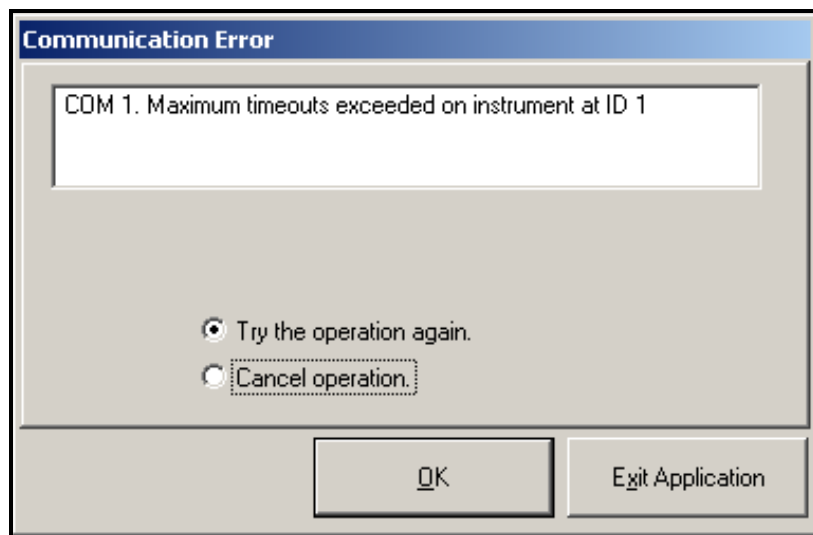

Figure C-7: Communication Error Screen

The screen offers the options of trying again or of canceling the operation. Click on the desired choice, and then on [OK] to confirm the choice or on [Exit Application] to close PanaView.

Note: *If you cannot resolve the problem, contact the factory for help.*

Editing Meter Properties

Through PanaView, you can edit the properties of your GC868. You can:

- Set the meter clock, or synchronize it with the PC clock
- Read, plot and save transducer signals
- Clear totalizers
- Save site files to the meter or PC
- Clear sites from the meter
- Print site files to the PC

To edit the properties of your GC868:

1. Highlight the meter (as shown in Figure C-6 on page C-6).
2. Open the “*Edit*” menu and select the “*Properties*” option, as shown in Figure C-8 below.

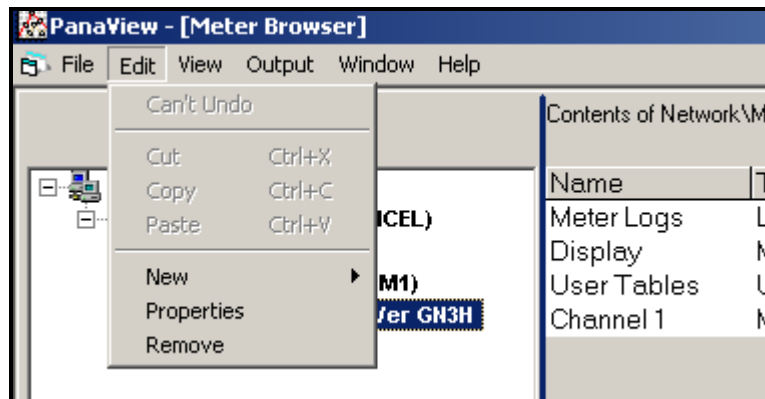

Figure C-8: *Properties* Option in the *Edit* Menu

Editing Meter Properties (cont.)

The window appears similar to Figure C-9 below. To perform a specific task, refer to the appropriate section on the following pages.

- Setting the Meter Clock (page C-9)
- Reading Transducer Signals (page C-10)
- Plotting Transducer Signals (page C-10)
- Saving Transducer Signals (page C-11)
- Clearing Totalizers (page C-11)
- Handling Site Files (page C-12)

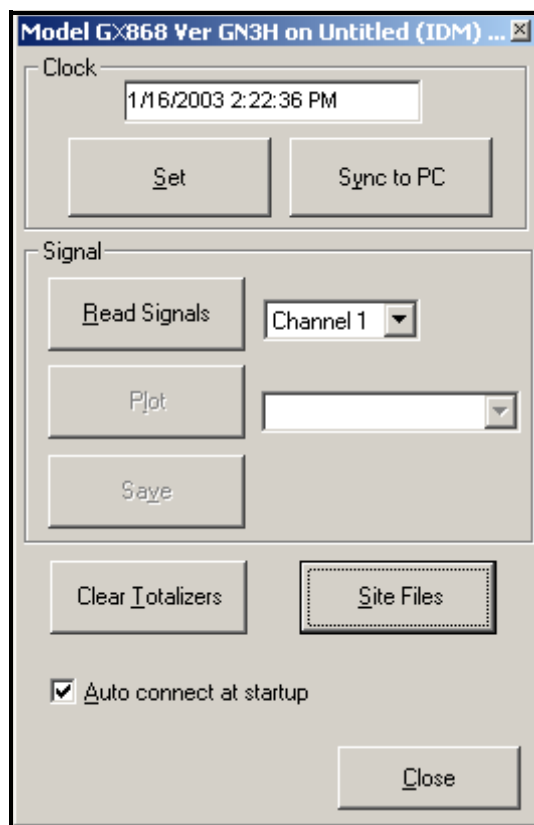

Figure C-9: Properties Window for IDM-Based Meter

Note: For illustration purposes, the meter shown here is a one-channel GX868 flowmeter. Specific parameters will vary with your particular meter.

Setting the Meter Clock

The meter's *Time* may be reset in three different ways:

- manually enter the time and date in the text box, or
- click on the [Sync to PC] option button to have PanaView set the time and date to the current PC setting, or
- click on the [Set] option button to open the dialog box shown in Figure C-10 below. Set the desired date and time as indicated, and click on the [OK] option button.



Figure C-10: Time and Date Selection Window

Reading Transducer
Signals

To read a *Signal* from the meter:

1. Click on the *Read Signals* button. (If the meter is a multi-channel instrument, open the Channel drop-down menu and click on the desired channel.) After a moment, the *Properties* window appears similar to Figure C-11 below.



Figure C-11: Active Signal Options in Properties Window

2. To select a different signal type, open the signal menu at the right (shown here with *Raw Upstream* highlighted) and click on the desired signal.

Plotting Transducer
Signals

To *plot* the selected signal, click on *Plot*. A graphical window opens, as shown in Figure C-12 below.

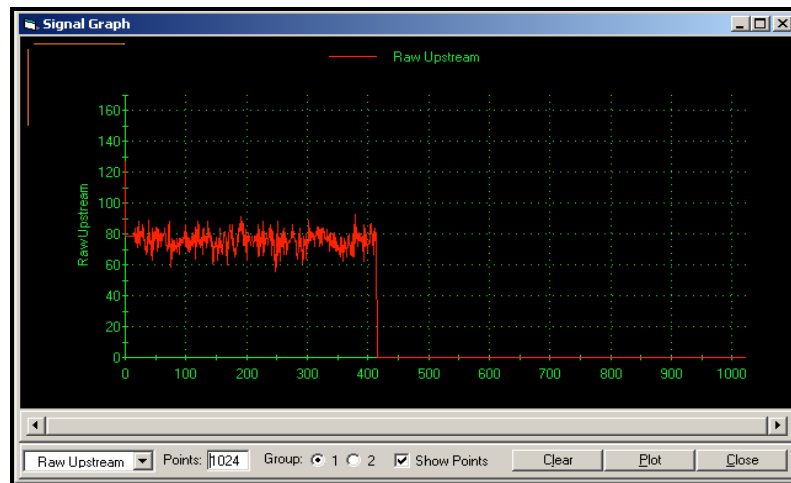

Figure C-12: Signal Graph Window

Saving Transducer Signals To *save* the raw signal, click *Save*. A window opens similar to Figure C-13 below. Enter the desired name, and click *Save* to save the signal as a text file.

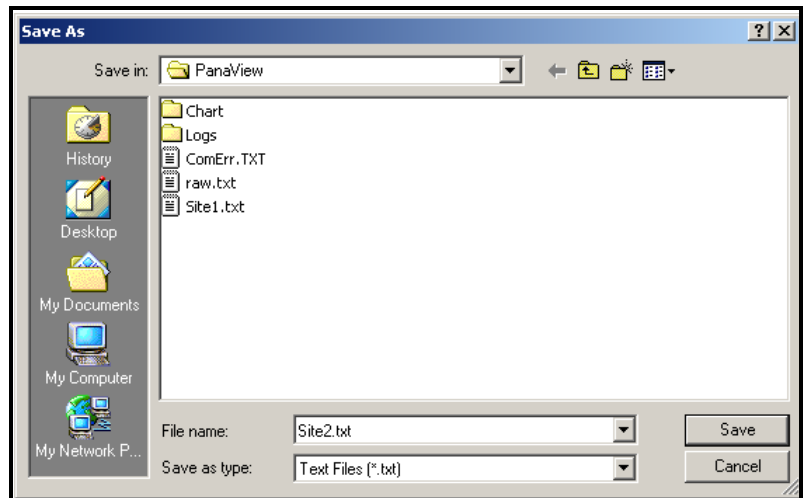

Figure C-13: Save As Window

Clearing Totalizers To clear the meter totalizers, click on the *Clear Totalizers* button in the *Properties* window. The meter totalizers are reset to 0.

Handling Site Files

To access site files, click on the *Site Files* button in the *Properties* window. The *Site File Operations* window (shown in Figure C-14 below) opens.

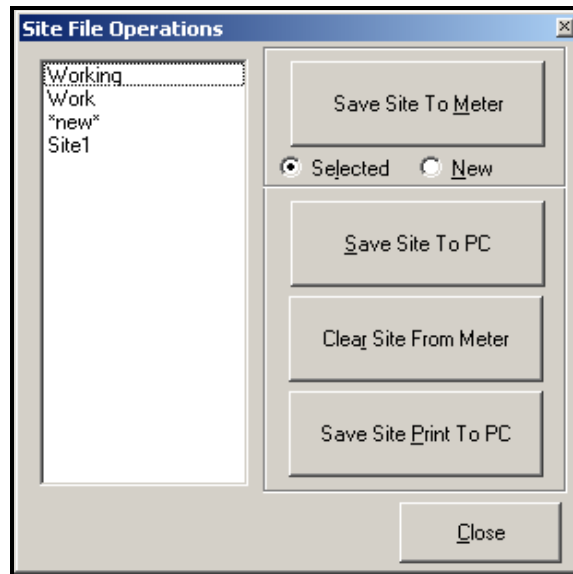

Figure C-14: *Site File Operations* Window

Saving an Existing Site to the Meter

To save an existing site to the meter:

1. Select the radio button for *Selected* and highlight an existing site in the left pane.
2. Then click on the *Save Site to Meter* button. A screen opens similar to Figure C-15 below.

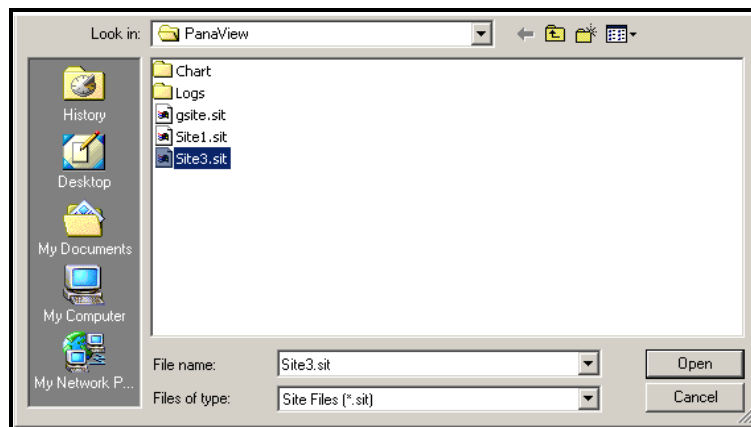

Figure C-15: *Site File Selection*

3. Highlight the desired site and click *Open*. PanaView sends the site to the meter.

Saving a New Site to the Meter

To save a new site to the meter:

1. Select the radio button for *New* and click on the *Save Site to Meter* button.
2. A window opens similar to Figure C-16 below. Enter the desired name, and click [OK].

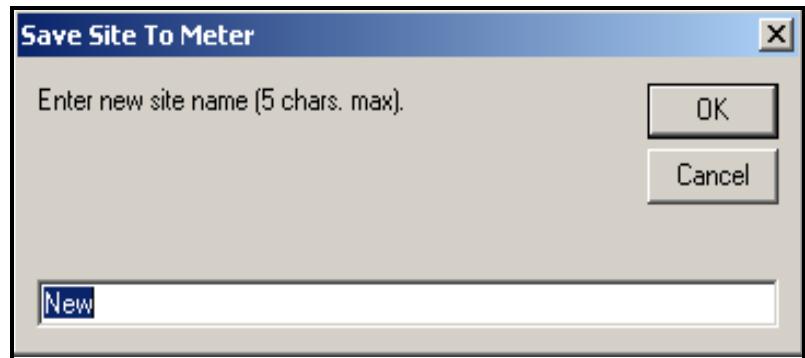

Figure C-16: Site Name Entry Window

3. The *Site File Selection* window (Figure C-15 on page C-12) opens. Highlight a site with the desired settings, and click [Open]. PanaView saves the site in the meter with the new name and the desired settings.

Saving a Site to the PC

To save a site to the PC:

1. Highlight the desired site in the left pane. (See Figure C-14 on page C-12.)
2. Click *Save Site to PC*. A window opens similar to Figure C-13 on page C-11.
3. Enter the desired site name and click [Save]. PanaView saves the site in the PanaView folder unless otherwise specified.

Note: *If you have created a site on the meter after opening the Site File Operations window, you must close and reopen the window to click on the new site.*

Clearing a Site from the Meter

To clear a site from the meter:

1. Highlight the site in the left pane. (See Figure C-14 on page C-12.)
2. Click *Clear Site From Meter*.
3. The program asks for confirmation. Click [OK]. The meter deletes the designated file.

Saving a Site in Text Form

To store the data from a site file as a text file for display or printout:

1. Highlight the site in the left pane. (See Figure C-14 on page C-12.)
2. Click *Save Site Print to PC*.
3. The *Site File Selection* window (shown in Figure C-15 on page C-12) opens. Enter the desired site name (now with a .prt suffix) and click [Save]. PanaView displays a text version of the site, as shown in Figure C-17 below.

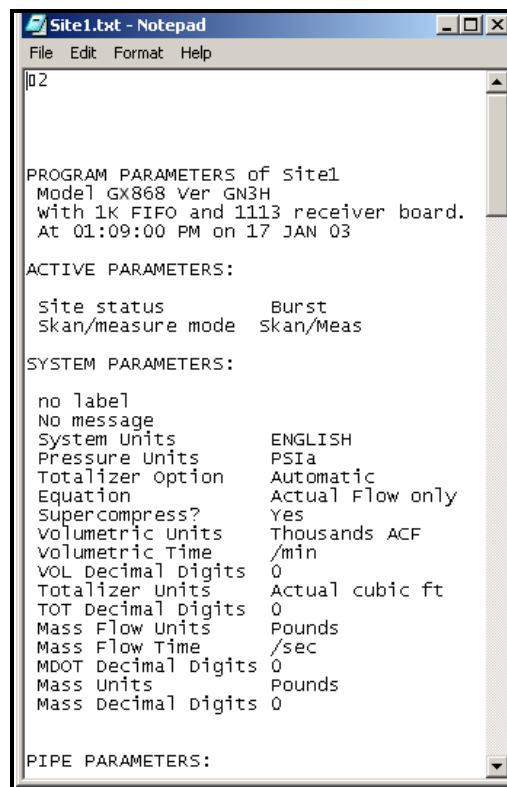

```

Site1.txt - Notepad
File Edit Format Help
02

PROGRAM PARAMETERS of site1
Model GX868 Ver GN3H
with 1K FIFO and 1113 receiver board.
At 01:09:00 PM on 17 JAN 03

ACTIVE PARAMETERS:

Site status          Burst
Skan/measure mode   Skan/Meas

SYSTEM PARAMETERS:

no label
No message
System Units         ENGLISH
Pressure Units       PSia
Totalizer option     Automatic
Equation             Actual Flow only
Supercompress?      Yes
Volumetric Units     Thousands ACF
volumetric Time      /min
VOL Decimal Digits  0
Totalizer Units      Actual cubic ft
TOT Decimal Digits  0
Mass Flow Units      Pounds
Mass Flow Time       /sec
MDOT Decimal Digits 0
Mass Units           Pounds
Mass Decimal Digits 0

PIPE PARAMETERS:

```

Figure C-17: Printout of Site File

4. Click [Close] once to close the *Site File Operations* window, and a second time to close the *Properties* window and return to the *Meter Browser*.

Changing Meter Settings Through PanaView, GC868 users can handle remote programming of the meter. They can:

- Program and change a meter's operating parameters;
- Set up, start, and stop logs;
- Calibrate and test inputs and outputs;
- Clear various files.

To access meter programming:

1. Enter the *New Meter Browser* option from the “File” menu.
2. Expand the network tree until you reach the desired meter.
3. Then expand the meter tree as shown in Figure C-18 below.

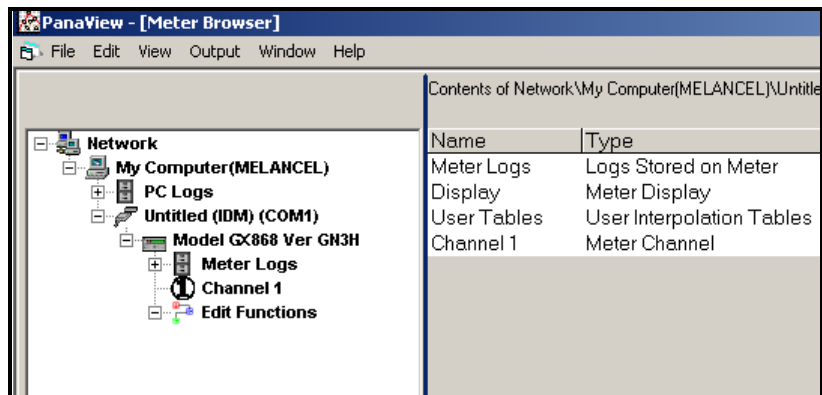

Figure C-18: *New Meter Browser* with Meter Branch

Changing Meter Settings (cont.)

4. From the meter tree, expand the *Edit Functions* option. The window now appears similar to Figure C-19 below, with a list of available menus. The menus listed are those available on the meter.

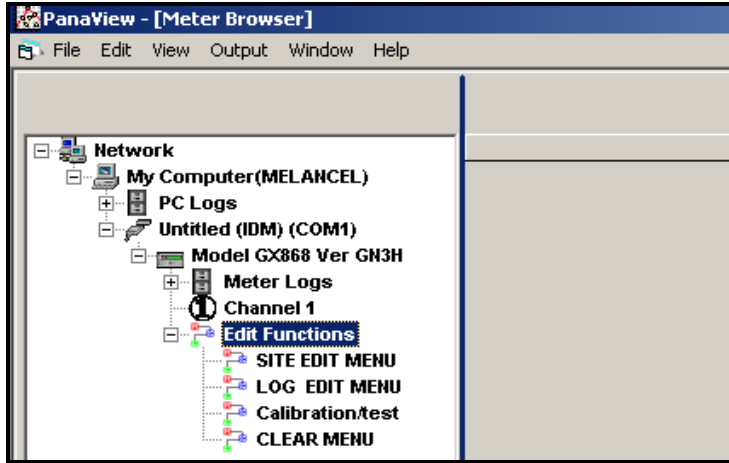

Figure C-19: Meter Tree with *Edit Functions* Option

5. To open a particular menu, double-click on that menu on the tree. For example, if you double-click on the Site Edit Menu, a window opens similar to Figure C-20 below.

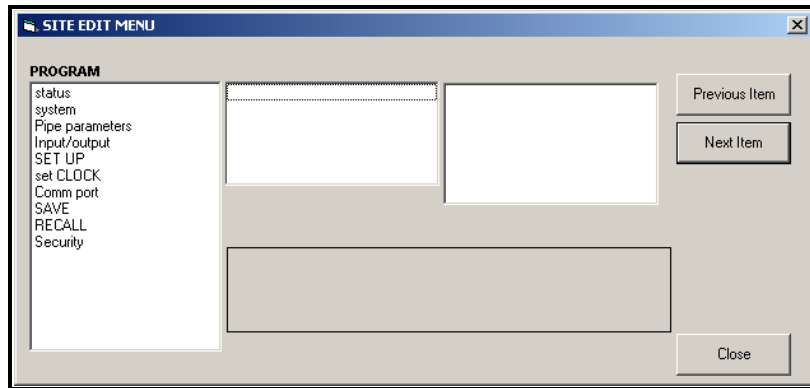

Figure C-20: Site Edit Menu Window

Note: *The options listed in the left pane correspond to the options available in the GX868 PROGRAM menus. For more information about the options in your instrument program and about appropriate parameters for the GC868, consult the previous chapters in this manual.*

Changing Meter Settings (cont.)

6. To enter a particular option:
 - a. Highlight and double-click on the desired option in the left pane. Figure C-21 below shows the first entry (Transducer Number) in the *Pipe parameters* option. The title above the center pane lists the current entry, while the center pane displays the available selections for that entry.
 - b. Click on the desired choice; if the entry requires a numeric value, change the value displayed in the right pane.

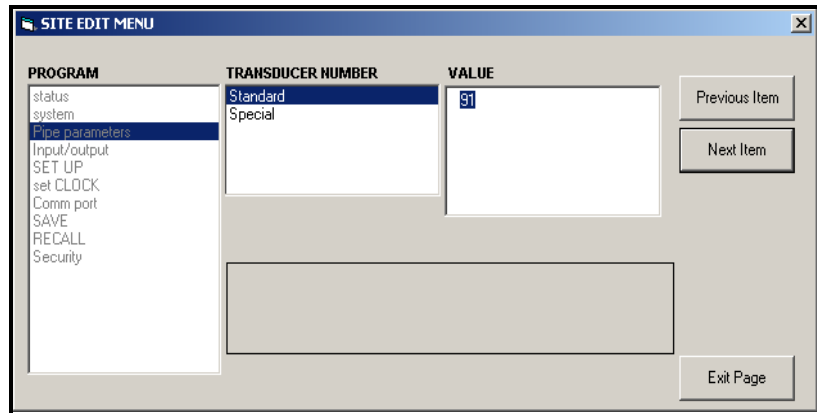

Figure C-21: Pipe Parameters Option in the Site Edit Menu

- c. Do one of the following:

Click on [Next Item] to proceed to the next menu item,

or

Click on [Previous Item] to return back through the menu to a previous item.

Note: *If you click on either [Next Item] or [Previous Item] without changing the settings, the current settings remain unchanged.*

As you step through the menu, the bottom panel lists the current settings you have modified or left unchanged (see Figure C-22 on page C-18). If you modify or step through more than five items, a scroll bar at the right of the panel lets you review the earlier settings.

Changing Meter Settings (cont.)

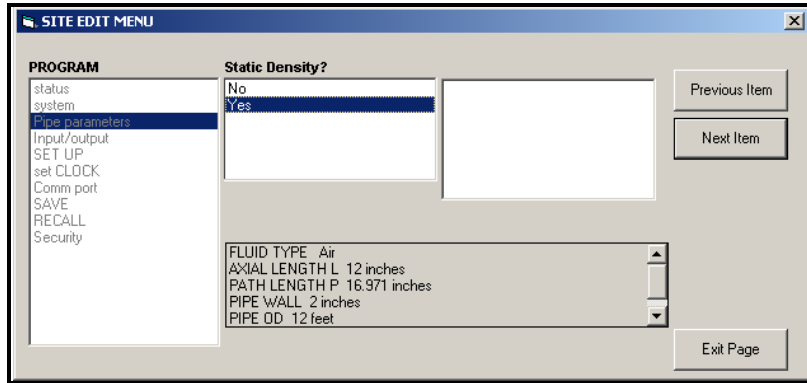

Figure C-22: Site Edit Menu with Current Settings

7. When you have completed entering parameters in a given option, click [Exit Page] to close the option. You can then double-click on another option, or click [Close] to close the window.

You can double-click on another menu to modify its settings, or return to the *New Meter Browser*. For additional PanaView functions, refer to the *PanaView User's Manual*.

Appendix D

Foundation Fieldbus Communications

- Optional MeasurementsD-1
- Configuration Utility SetupD-2
- Selecting the Desired MeasurementsD-2
- Selecting Units for AI BlocksD-4
- Resetting Instrument TotalizersD-5
- Function Block Application.....D-6

Optional Measurements Foundation Fieldbus provides a means of communicating with the flowmeter. The patent numbers which apply are 5,909,363 and 6,424,872.

This Foundation Fieldbus device supports 2 Analog Input (AI) blocks, which can be configured to supply the following measurements on the network (see Table D-1 below).

Table D-1: Available Measurements Using a 2-Channel GC868

Channel 1	Units	Channel 2	Units	Average	Units
Ch1 Velocity	ft/s or m/s*	Ch2 Velocity	ft/s or m/s*	Avg Velocity	ft/s or m/s*
Ch1 Act Volumetric	VOL_U	Ch2 Act Volumetric	VOL_U	Avg Act Volumetric	VOL_U
Ch1 Std Volumetric	VOL_U	Ch2 Std Volumetric	VOL_U	Avg Std Volumetric	VOL_U
Ch1 Fwd Totals	TOT_U	Ch2 Fwd Totals	TOT_U	Avg Fwd Totals	TOT_U
Ch1 Rev Totals	TOT_U	Ch2 Rev Totals	TOT_U	Avg Rev Totals	TOT_U
Ch1 #Tot Digits**	none	Ch2 #Tot Digits**	none	Avg #Tot Digits**	none
Ch1 Mass Flow	MASS_U	Ch2 Mass Flow	MASS_U	Avg Mass Flow	MASS_U
Ch1 Fwd Mass Totals	MTOT_U	Ch2 Fwd Mass Totals	MTOT_U	Avg Fwd Mass Totals	MTOT_U
Ch1 Rev Mass Totals	MTOT_U	Ch2 Rev Mass Totals	MTOT_U	Avg Rev Mass Totals	MTOT_U
Ch1 #Mass Tot Digits	none	Ch2 #Mass Tot Digits	none	Avg #Mass Tot Digits	none
Ch1 Timer	sec	Ch2 Timer	sec	Avg Timer	sec
Ch1 Error Code	none	Ch2 Error Code	none	Avg Error Code	none
Ch1 SSUP	none	Ch2 SSUP	none	Avg SSUP	none
Ch1 SSDN	none	Ch2 SSDN	none	Avg SSDN	none
Ch1 Sound Speed	ft/s or m/s*	Ch2 Sound Speed	ft/s or m/s*	Avg Sound Speed	ft/s or m/s*
Ch1 Density***	see note	Ch2 Density***	see note		
Ch1 Temperature	Deg F or C*	Ch2 Temperature	Deg F or C*		
Ch1 Pressure	PRESS_U	Ch2 Pressure	PRESS_U		

*Metric or English units are determined by the setup of the flowmeter.

**Totalizer digits are available for informational purposes only. Respective totals are automatically scaled by the Tot Digits value selected in the flowmeter setup.

***If the meter is outputting Mole Weight, the unit is "mw", otherwise it is the programmed pressure unit.

VOL_U, TOT_U, MASS_U, MTOT_U and PRESS_U are determined by the units chosen for these measurements in the flowmeter setup. See the instrument User's Manual for the setup of these parameters.

Configuration Utility Setup

The following is an *example* setup using National Instruments Configuration Utility v3.1.

Figure D-1 below shows the Configuration Utility with a flowmeter on the network (GE Flow-XMT).

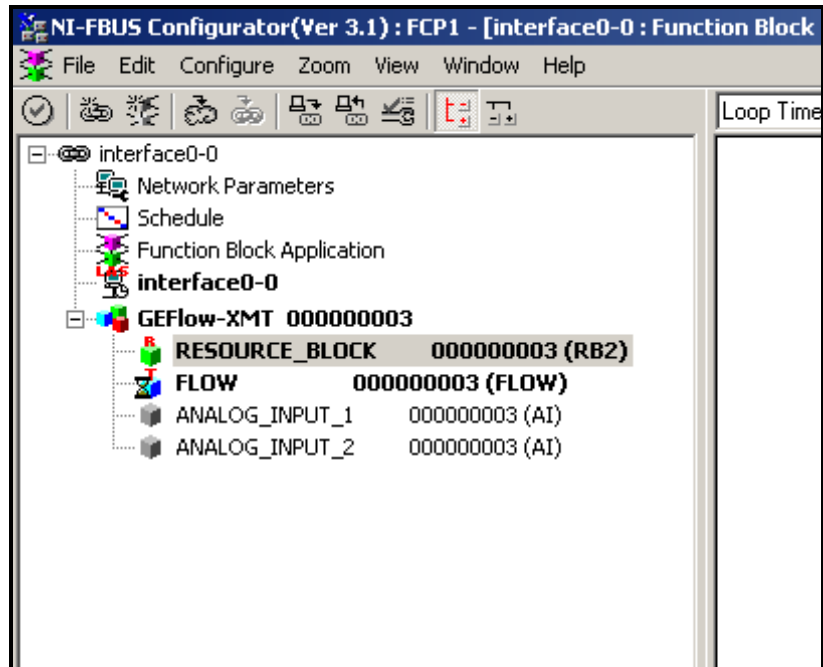

Figure D-1: Configuration Utility Setup Example

Note: *The following procedures assume that the device has been placed in the OOS (out-of-service) mode before executing.*

Selecting the Desired Measurements

To set the measurement unit for each AI:

1. Double click on the FLOW Transducer Block (in the tree under GEFlow-XMT).
2. Select the **Others** tab and open the drop down list for the PRIMARY_SELECTOR and SECONDARY_SELECTOR (refer to Figure D-2 on page D-3).
3. Choose the unit from the list (see Figure D-2 on page D-3).

This unit will correspond to the unit that is available in the AI block for network connection. The PRIMARY_SELECTOR unit will correspond to ANALOG_INPUT_1 and the SECONDARY_SELECTOR will correspond to ANALOG_INPUT_2.

Selecting the Desired Measurements (cont.)

- After the desired measurements have been selected for the PRIMARY and SECONDARY SELECTOR, choose the unit system (UNIT_SELECTOR above the PRIMARY_SELECTOR) that has been programmed in the flowmeter (English or SI).

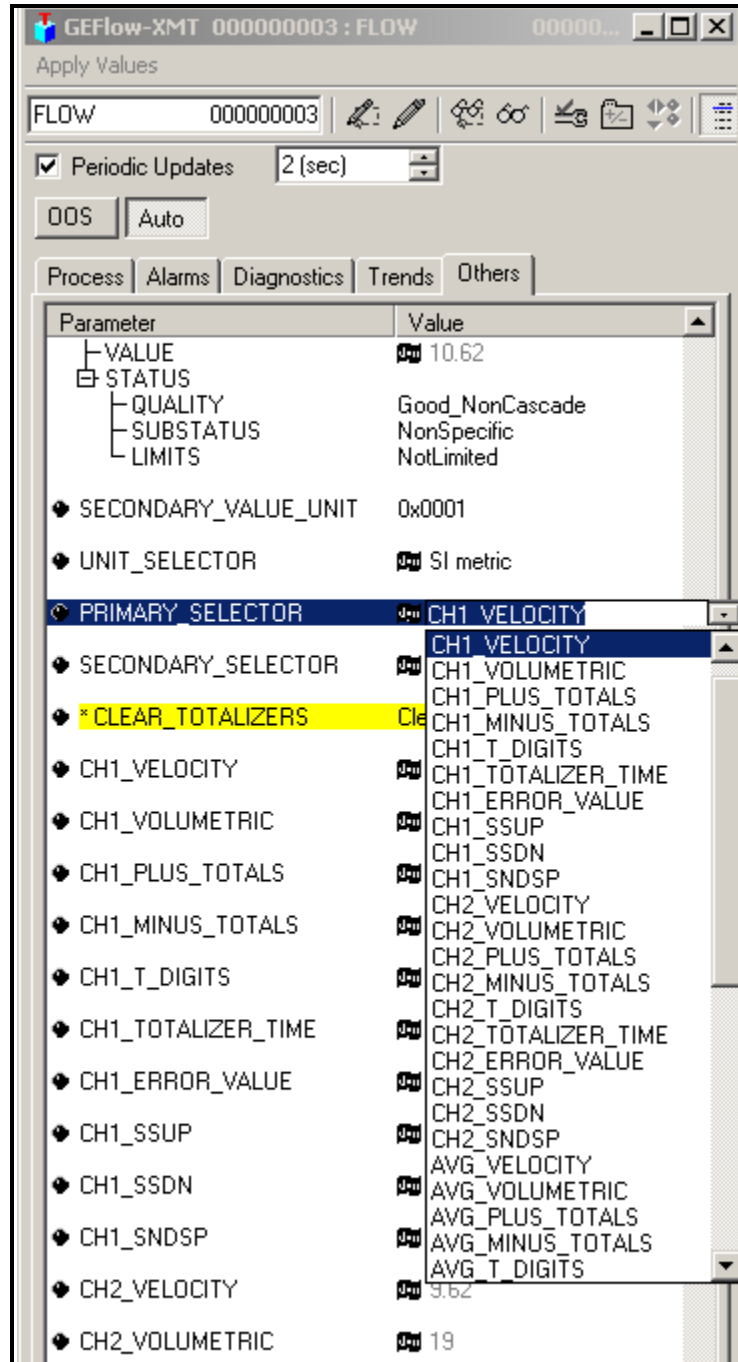

Figure D-2: Primary Selector Drop Down List

Selecting Units for AI Blocks

To select the units for the individual AI blocks:

1. Double click on the AI block for which you wish to set the units (ANALOG_INPUT_1 or ANALOG_INPUT_2 in the tree under GEFlow-XMT; see Figure D-1 on page D-2).
2. Select the **Scaling** tab and set the unit for the measurement based on the flowmeter settings.

For example, if the flowmeter was set to use the metric unit system and the PRIMARY_SELECTOR was set to use VELOCITY you would choose **m/s** for the unit as shown in Figure D-3 below.

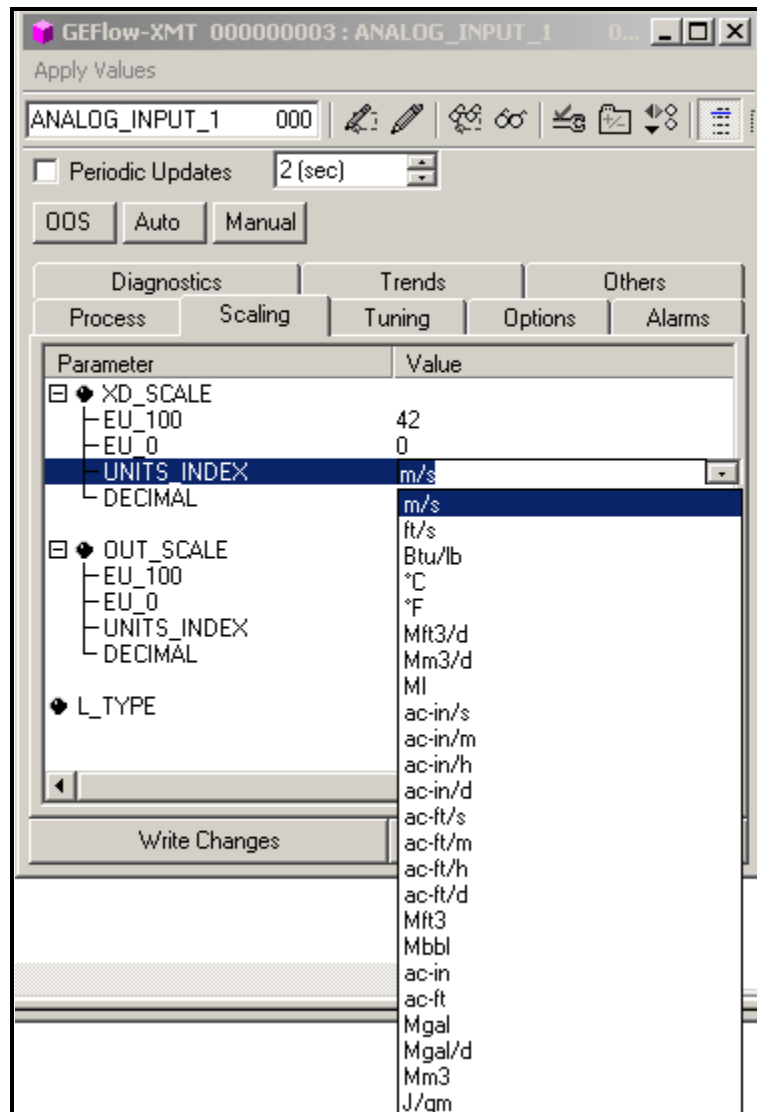

Figure D-3: Units Index Drop Down List

Resetting Instrument Totalizers

To reset the instrument totalizers:

1. Double click on the FLOW transducer block (in the tree under GEFlow-XMT; see Figure D-1 on page D-2).
2. Select the **Others** tab and scroll down to the CLEAR_TOTALIZERS listing.
3. Select **Clear** from the drop down list box (see Figure D-4 below).
4. After the totals have been reset, select **Normal** from the drop down list box to resume total accumulation.

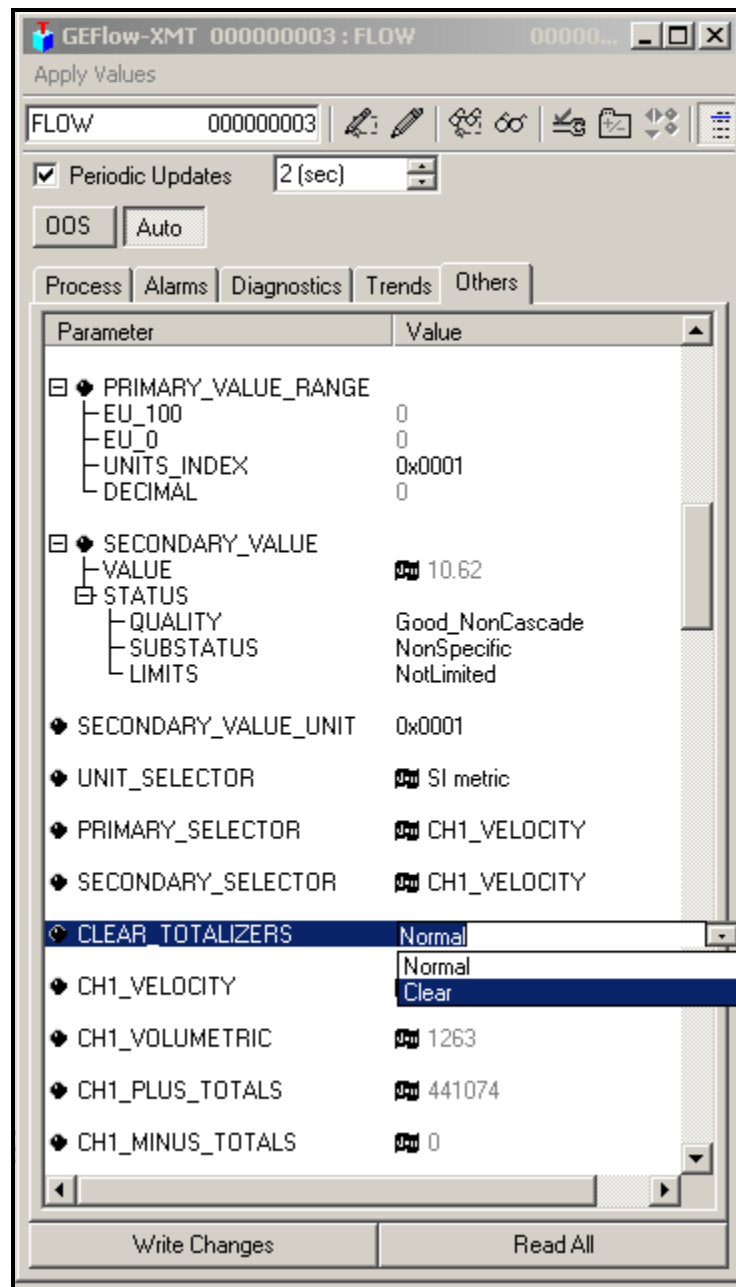

Figure D-4: Clear Totalizers Drop Down List

Function Block Application

Figure D-5 below is an example setup using the Function Block Application editor. The flowmeter AI blocks, along with the AO and PID of another device on the network, are displayed. We have connected the AI_1 OUT of the flowmeter to the CAS IN of the AO block. We have also connected the AI_2 OUT of the flowmeter to the CAS IN of the PID block.

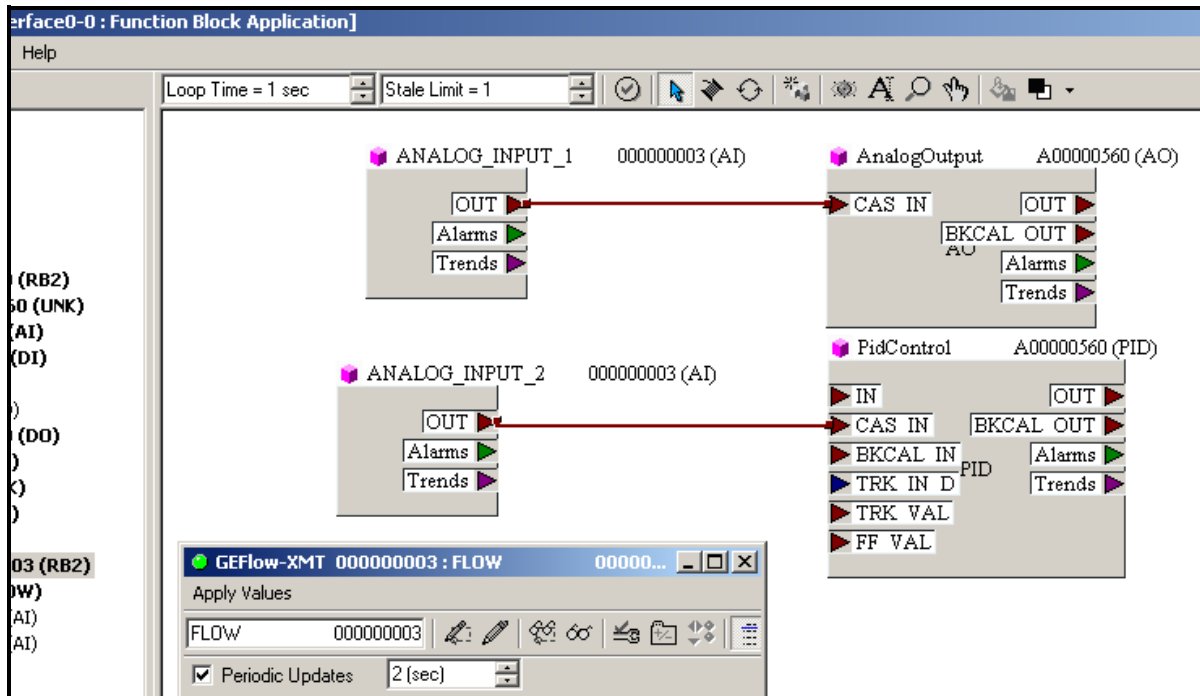

Figure D-5: Function Block Application

Index

- A**
- ACTIV
 Submenu 1-9
AVRG Submenu 1-25
- B**
- BACKL
 Automatic Timeout 2-14
 Submenu 2-1, 2-14
Backlight
 See BACKL
Basic Programming Data B-2
Baud Rate
 Available Options 1-45
 Setting 1-45
BIG
 Measurement Parameter Options 2-2
 Screen Format 2-2
 Submenu 2-1, 2-2
Burst Mode 1-22
- C**
- Cables, RS232 Interface 6-1
CH1/CH2
 Menu 1-9
Clear Site from Meter C-14
Clear Totalizers C-11
Clearing Data 5-1
CLOCK
 Menu Map 1-34
 Submenu 1-34
CLR Menu Map 5-1
COMM Menu Map 1-45
Communications Port, Setting Up C-2, C-3
- D**
- Data Records B-2
DATA Submenu 4-2
Date, Programming 1-34
DISP
 Menu 2-1
Displaying Data
 BIG Format 2-2
 Display Menu 2-1
 DUAL Format 2-3
 Graphical Format 2-4
 Log File 2-7
 Log File Display Options 2-8, 2-10
 Log File, Graphical Format 2-9
 Log File, Numeric Format 2-8
 Numeric Key Functions 2-13
 SLEEP Mode 2-15
 Transducer Signals 2-11
 Typical SIGNAL Display Screen 2-12
DUAL
 Screen Format 2-3
 Submenu 2-1, 2-3
- E**
- Edit Functions Option C-16
Edit Menu C-2
ERROR
 Menu 1-37
 Submenu 3-1, 3-9
Error Handling
 2-Path 1-37
 Response Options 1-37
Ethernet
 Setting Up 6-9
 Setting up with PanaView C-3
- F**
- Foundation Fieldbus
 Available Measurements D-1
 Communications D-1
 Option Card 1-45
Function Keys, GRAPH Screen Format 2-5

Index (cont.)

G

GLOBL
 Menu 1-33
 Submenus 1-33

GRAPH
 Screen Display Options 2-6
 Screen Format 2-4
 Setting Up 2-4
 Submenu 2-1, 2-4
 Typical Display Screen 2-5
 Using Function Keys 2-5

H

Help, On-Line 1-6

I

I/O (CH1/CH2)
 Menu Map 1-16
 Submenu 1-16

IDM-Compatible Meters C-1

INIT Submenu 1-25

Instrument Data Manager (IDM) 1-45

K

Keypad
 Description 1-2
 Using 1-2

Keys
 Audio Alarm Volume 1-7
 Console Control 1-7
 Display Backlight 1-7
 Display Contrast 1-7
 Stopwatch Totalizer 1-7
 Table of Functions 1-3

L

LOG
 Entering the Submenu 2-7
 Menu Map 2-7
 Submenu 2-1, 2-7, 4-5, 5-4

Log File
 Header 3-1
 Pages of Memory 3-1
 Records 3-1

Logging Data 3-1
 Calculating Number of Pages 3-7
 Calculating Number of Records 3-7
 Circular 3-3
 Measurement Parameter Options 3-2
 Menu 3-1
 Non-Circular 3-3
 Time Increment 3-6

M

Mass Flow Units
 Available Options 1-36
 Setting 1-36

Measurements, Foundation Fieldbus D-1

MEM Submenu 3-1, 3-7

Menu
 See Menu Name

Menu Map
 CLR 5-1
 LOG Submenu 2-7
 PRNTR Submenu 4-9
 SGNLS Submenu 4-10
 STOP Submenu 4-8

Menus, Edit C-2

Meter Settings, Changing C-15

MODBUS Register Map 1-47

MODBUS/TCP, Setting Up 6-10

N

Network ID Number 1-45

Numeric Keys, Displaying SIGNAL Data ... 2-13

Index (cont.)

S	T
SAVE	TOTAL Submenu 5-2
Menu 1-52	Transducer Signals, Displaying 2-11
Menu Map 1-52	Transducer, Special 1-12
Save Site Print to PC C-14	
Save Site to Meter C-12	U
Save Site to PC C-13	User Program
SECUR	Accessing 1-8
Menu 1-50	Submenus 1-1
Submenus 1-50	
Serial Communications	V
Baud Rate 1-45	Volumetric Units
COMM Menu 1-45	Options 1-11
Network ID Number 1-45	Selecting 1-11
SETUP	
Submenu 1-19	
SGNLS	
Menu Map 4-10	
Submenu 4-10	
Signal	
Graph C-10	
Plot C-10	
Reading C-10	
Save C-11	
Type C-10	
Signal Array Data, Printing 4-10	
SIGNL	
Option 1-19	
Submenu 2-1, 2-11	
Typical Display Screen 2-12	
Site Edit Menu C-16	
Site File Operations C-12	
Site Files, Handling C-12	
SITE Submenu 5-3	
SLEEP Submenu 2-1, 2-15	
STD Submenu 3-1, 3-2	
STOP	
Menu Map 4-8	
Submenu 3-1, 3-8, 4-8	
Stopwatch Totalizer, Programming 1-35	
Submenu	
See Submenu Name	
System Units, Entering 1-35	

We,

Panametrics Limited
Shannon Industrial Estate
Shannon, County Clare
Ireland

declare under our sole responsibility that the

GC868 Gas Clamp-On Ultrasonic Flowmeter

to which this declaration relates, are in conformity with the following standards:

- EN 61326:1998, Class A, Annex A, Continuous Unmonitored Operation
- EN 61010-1:1993 + A2:1995, Overvoltage Category II, Pollution Degree 2

following the provisions of the 89/336/EEC EMC Directive and the 73/23/EEC Low Voltage Directive.

Shannon - June 1, 2002

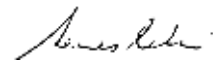

Mr. James Gibson
GENERAL MANAGER



CERT-DOC-H0



August 2004

Nous,

Panametrics Limited
Shannon Industrial Estate
Shannon, County Clare
Ireland

déclarons sous notre propre responsabilité que les

GC868 Gas Clamp-On Ultrasonic Flowmeter

relatif à cette déclaration, sont en conformité avec les documents suivants:

- EN 61326:1998, Class A, Annex A, Continuous Unmonitored Operation
- EN 61010-1:1993 + A2:1995, Overvoltage Category II, Pollution Degree 2

suivant les règles de la Directive de Compatibilité Electromagnétique 89/336/EEC et de la Directive Basse Tension 73/23/EEC.

Shannon - June 1, 2002

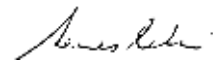

Mr. James Gibson
DIRECTEUR GÉNÉRAL



CERT-DOC-H0



August 2004

Wir,

Panametrics Limited
Shannon Industrial Estate
Shannon, County Clare
Ireland

erklären, in alleiniger Verantwortung, daß die Produkte

GC868 Gas Clamp-On Ultrasonic Flowmeter

folgende Normen erfüllen:

- EN 61326:1998, Class A, Annex A, Continuous Unmonitored Operation
- EN 61010-1:1993 + A2:1995, Overvoltage Category II, Pollution Degree 2

gemäß den Europäischen Richtlinien, Niederspannungsrichtlinie Nr.: 73/23/EG und EMV-Richtlinie Nr.: 89/336/EG.

Shannon - June 1, 2002

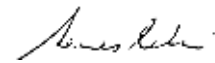

Mr. James Gibson
GENERALDIREKTOR



CERT-DOC-H0



August 2004



USA

1100 Technology Park Drive
Billerica, MA 01821-4111
Web: www.gesensing.com

Ireland

Sensing House
Shannon Free Zone East
Shannon, Co. Clare
Ireland

