

Quick Start Manual • May 2008



English
Dansk
Deutsch
Ελληνικά
Español
Français
Italiano
Nederlands
Português
Suomi
Svenska

million
in one

sitrans

LR200 (HART)

SIEMENS

SITRANS LR200 (HART) with Siemens LUI Interface: Quick Start Manual

This manual outlines the essential features and functions of the SITRANS LR200 (HART). We strongly advise you to acquire the detailed version of the manual so you can use your device to its fullest potential. The complete manual can be downloaded from the SITRANS LR200 product page of our web site at: www.siemens.com/LR200. The printed manual is available from your local Siemens Milltronics representative.

Questions about the contents of this manual can be directed to:

Siemens Milltronics Process Instruments Inc.
1954 Technology Drive, P.O. Box 4225
Peterborough, Ontario, Canada, K9J 7B1
Email: techpubs.smpi@siemens.com

**Copyright Siemens Milltronics
Process Instruments Inc. 2008.
All Rights Reserved**

Disclaimer of Liability

We encourage users to purchase authorized bound manuals, or to view electronic versions as designed and authored by Siemens Milltronics Process Instruments Inc. Siemens Milltronics Process Instruments Inc. will not be responsible for the contents of partial or whole reproductions of either bound or electronic versions.

While we have verified the contents of this manual for agreement with the instrumentation described, variations remain possible. Thus we cannot guarantee full agreement. The contents of this manual are regularly reviewed and corrections are included in subsequent editions. We welcome all suggestions for improvement.

Technical data subject to change.

MILLTRONICS is a registered trademark of Siemens Milltronics Process Instruments Inc.

Technical Support

Support is available 24 hours a day.

To find your local Siemens Automation Office address, phone number, and fax number, go to:

www.siemens.com/automation/partner:

- Click on the tab **Contacts by Product** then find your product group (**+Process Automation > +Process Instrumentation > +Level Measuring Instruments**).
- Select the team **Technical Support**. Click on **Next**.
- Click on a continent, then a country, followed by a city. Click on **Next**.

For on-line technical support go to: www.siemens.com/automation/support-request

- Enter the device name (SITRANS LR200) or order number, then click on **Search**, and select the appropriate product type. Click on **Next**.
- Enter a keyword describing your issue. Then either browse the relevant documentation, or click on **Next** to email a description of your issue to Siemens Technical Support staff.

Siemens A&D Technical Support Center:

phone +49 180 50 50 222

fax +49 180 50 50 223

Safety Guidelines

Warning notices must be observed to ensure personal safety as well as that of others, and to protect the product and the connected equipment. These warning notices are accompanied by a clarification of the level of caution to be observed.



WARNING: relates to a caution symbol on the product, and means that failure to observe the necessary precautions can result in death, serious injury, and/or considerable material damage.



WARNING¹⁾: means that failure to observe the necessary precautions can result in death, serious injury, and/or considerable material damage.

Note: means important information about the product or that part of the operating manual.

FCC Conformity

US Installations only: Federal Communications Commission (FCC) rules



WARNING: Changes or modifications not expressly approved by Siemens Milltronics could void the user's authority to operate the equipment.

Notes:

- This equipment has been tested and found to comply with the limits for a Class A digital device, pursuant to Part 15 of the FCC Rules. These limits are designed to provide reasonable protection against harmful interference when the equipment is operated in a commercial environment.
- This equipment generates, uses, and can radiate radio frequency energy and, if not installed and used in accordance with the instruction manual, may cause harmful interference to radio communications. Operation of this equipment in a residential area is likely to cause harmful interference to radio communications, in which case the user will be required to correct the interference at his own expense.

SITRANS LR200



WARNING: SITRANS LR200 is to be used only in the manner outlined in this manual, otherwise protection provided by the equipment may be impaired.

Note:

- This product is intended for use in industrial areas. Operation of this equipment in a residential area may cause interference to several frequency based communications.

SITRANS LR200 is a 2-wire 6 GHz pulse radar level transmitter for continuous monitoring of liquids and slurries in storage and process vessels including high temperature and pressure, to a range of 20 m (66ft).

The device consists of an electronic circuit coupled to the antenna and either a threaded or flange type process connection.

¹⁾ This symbol is used when there is no corresponding caution symbol on the product.

Communication is via HART¹⁾. Signals are processed using Process Intelligence.

Specifications

For a complete listing, see the SITRANS LR200 (HART) Instruction Manual. For Approvals information, please refer to the device nameplate and the process device tag.

Ambient/Operating Temperature

Notes:

- Process temperature and pressure capabilities are dependent upon information on the process device tag. The reference drawing listed on the tag can be downloaded from the Siemens website at: www.siemens.com/LR200.
- Maximum temperature is dependent on the process connection, antenna materials, and vessel pressure. See *Maximum Process Temperature Chart* on page 22, for more details. Process Pressure Temperature derating curves are available in the full manual.

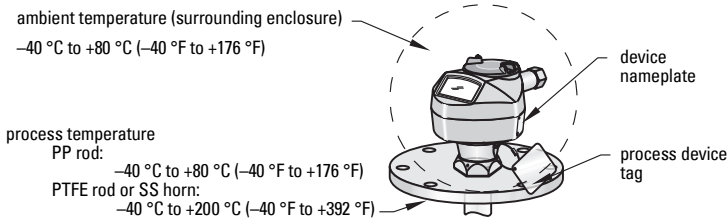

Power



General Purpose:
Non-incendive (FM/US only):
Intrinsically Safe:

Nominal 24 V DC at
max. 550 Ohm loop
resistance.



Flameproof:
Increased Safety:
Explosion-proof (FM/CSA US/Canada only):

Nominal 24 V DC at
max. 250 Ohm loop
resistance.

Approvals

- General CSA_{US/C}, FM, CE
- Radio Europe (R&TTE), FCC, Industry Canada

(continued on next page)

¹⁾ HART[®] is a registered trademark of HART Communication Foundation.

- Hazardous Flameproof (Europe)¹⁾ ATEX II 1/2 G, EEx dm ia IIC T4
 Increased Safety (Europe)²⁾ ATEX II 1/2 G, EEx em ia IIC T4
 Explosion proof (US/Canada)³⁾ FM/CSA: (barrier not required)
 Class I, Div. 1, Groups A, B, C, D
 Class II, Div. 1, Groups E, F, G
 Class III T4

Note: Use appropriate conduit seals to maintain IP or NEMA rating.

Approvals (continued)

- Hazardous
 - Non-incendive (US)⁴⁾ FM: (barrier not required)
 Class I, Div. 2, Groups A, B, C, D T5
 - Intrinsically Safe⁵⁾ ATEX II 1 G, EEx ia IIC T4
 (Europe)
 (US/Canada) FM/CSA: (barrier required)
 Class I, Div. 1, Groups A, B, C, D
 Class II, Div. 1, Groups E, F, G
 Class III T4
 - (Australia) ANZEX Ex ia IIC T4
 (Tamb = -40 to +80 °C) IP67
 - (International) IECEX TSA 04.0020X T4
- Marine Lloyd's Register of Shipping
 ABS Type Approval

Programmer (infrared keypad)

Siemens Milltronics Infrared IS (Intrinsically Safe) Hand Programmer for hazardous and all other locations (battery is non-replaceable with a life expectancy of 10 years in normal use).

- approval ATEX II 1 G, EEx ia IIC T4, certificate SIRA 01ATEX2147
- FM/CSA: Class I, Div. 1, Groups A, B, C, D
- ambient temperature -20 to 40 °C (-5 to 104 °F)
- interface proprietary infrared pulse signal
- power 3 V lithium battery
- weight 150 g (0.3 lb)
- color black
- Part Number 7ML1930-1BK

¹⁾ See *Flameproof wiring* on page 9.

²⁾ See *Increased safety wiring* on page 10.

³⁾ See *Explosion-proof wiring (FM/CSA US/Canada only)* on page 10.

⁴⁾ See *Non-incendive wiring (FM/US only)* on page 11.

⁵⁾ See *Intrinsically Safe wiring* on page 11.

Pressure Application



WARNINGS:

- **This product is designated as a Pressure Accessory per Directive 97 / 23 / EC, and is not intended for use as a safety device.**
- **Never attempt to loosen, remove, or disassemble process connection or instrument housing while vessel contents are under pressure.**
- **Improper installation may result in loss of process pressure.**

Installation



WARNINGS:

- **Installation shall only be performed by qualified personnel and in accordance with local governing regulations.**
- **Materials of construction are chosen based on their chemical compatibility (or inertness) for general purposes. For exposure to specific environments, check with chemical compatibility charts before installing.**

Notes:

- The Process Device Tag shall remain with the process pressure boundary assembly¹⁾. In the event the device package is replaced, the Process Device Tag shall be transferred to the replacement unit.
- SITRANS LR200 units are hydrostatically tested, meeting or exceeding the requirements of the ASME Boiler and Pressure Vessel Code and the European Pressure Equipment Directive.

Installation guidelines

- Provide easy access for viewing the display and programming via the hand programmer.
- Provide an environment suitable to the housing rating and materials of construction.
- Provide a sunshield if the device will be mounted in direct sunlight.

¹⁾ The process pressure boundary assembly comprises the components that act as a barrier against pressure loss from the process vessel: that is, the combination of process connection body and emitter, but normally excluding the electrical enclosure.

Nozzle design

Notes:

- For nozzles 100 mm (4") in length or shorter use the 100 mm (4") shield.
- For nozzles 250 mm (10") in length or shorter use the 250 mm (10") shield.
- For details on other applications, please see the full manual.

- The end of the shield section should protrude a minimum of 10 mm (0.4") to avoid false echoes being reflected from the nozzle.

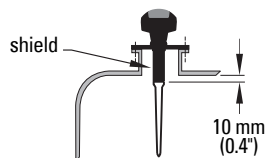

Location on a manhole cover

- A manhole cover is typically a covered nozzle with a diameter 610 mm (24") or greater.
- For optimum signal conditions, locate the antenna off-center, typically 100 mm (4") from the side.

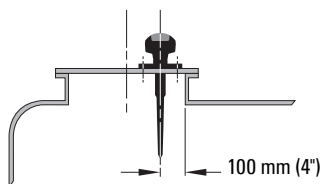

Nozzle location

! WARNING: For vessels with conical or parabolic tops, avoid mounting the instrument at the centre. (The concavity of the top can focus echoes into the centre, giving false readings.)

Note: Under certain circumstances, it may be acceptable to mount the device at the centre of a flat-topped tank. Please discuss this with your local Siemens representative.

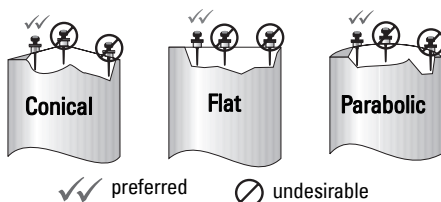

- Keep emission cone free of interference from ladders, pipes, I-beams or filling streams.
- Locate the antenna away from the side wall, to avoid interference from indirect echoes.
- Make allowance for the emission cone spreading, to avoid interference with vessel walls or obstructions.

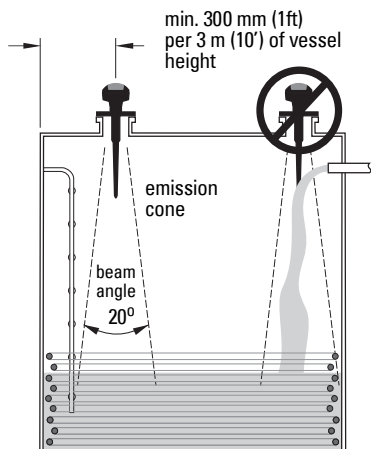

Installation instructions

Notes:

- There is no limit to the number of times the device can be rotated.
- Orient the front or back of the device towards the closest vessel wall.
- Do not rotate the enclosure after programming and device configuration (a polarity shift of the transmit pulse may cause an error).

Threaded Version

- 1) Before inserting the device into its mounting connection, check to ensure the threads are matching to avoid damaging them.
- 2) Screw the device into the process connection, and hand tighten. For pressure applications, use PTFE tape or other appropriate thread sealing compound, and tighten the process connection beyond hand-tight (max. torque 40 N·m (30 ft.lbs)).
- 3) To rotate the enclosure, first loosen the three set-screws securing the locking ring. After positioning the enclosure, retighten the screws.

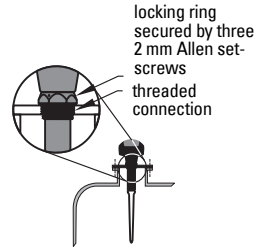

Flanged Version

! **WARNING: The user is responsible for the selection of bolting and gasket materials which will fall within the limits of the flange and its intended use, and which are suitable for the service conditions.**

Wiring Power

WARNINGS:



The DC input terminals shall be supplied from a source providing electrical isolation between the input and output, in order to meet the applicable safety requirements of IEC 61010-1.



All field wiring must have insulation suitable for rated voltages.

Connecting SITRANS LR200



WARNINGS:

- Check the device nameplate and process device tag, to verify the approval rating.
- Use appropriate conduit seals to maintain IP or NEMA rating.
- Read *Instructions specific to hazardous area installations* on page 13.

Notes:

- For detailed wiring instructions, please refer to the full Instruction Manual.
- Use twisted pair cable: AWG 22 to 14 (0.34 mm² to 2.5 mm²).
- Separate cables and conduits may be required to conform to standard instrumentation wiring practices, or electrical codes.

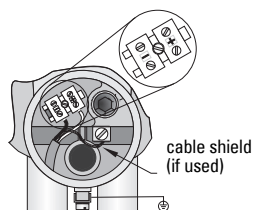
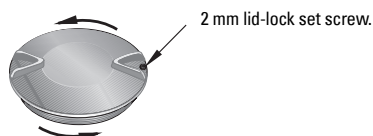

- 1) Use a 2 mm Allen key to loosen the lid-lock set screw then unscrew the cover.
- 2) Strip the cable jacket for approximately 70 mm (2.75") from the end of the cable, and thread the wires through the gland.
- 3) Connect the wires to the terminal as shown: the polarity is identified on the terminal block.
- 4) Ground the device according to local regulations.
- 5) Tighten the gland to form a good seal.
- 6) Close the lid and secure the locking ring before programming and device configuration. Do not rotate the device after it has been configured, as this may cause an error.

Connecting HART: typical PLC/mA configuration

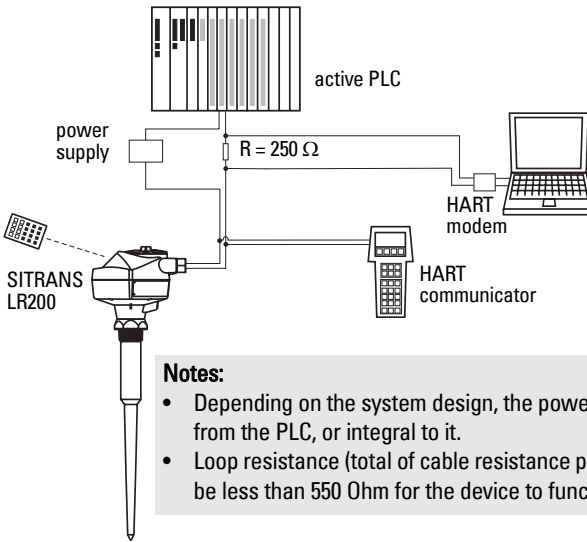

Notes:

- Depending on the system design, the power supply may be separate from the PLC, or integral to it.
- Loop resistance (total of cable resistance plus 250 Ohm [resistor]) must be less than 550 Ohm for the device to function properly.

Wiring setups for hazardous area installations

Note: ATEX certificates and connection drawings listed below can be downloaded from the product page of our website at: www.siemens.com/LR200.

There are five wiring options for hazardous area installations. In all cases, check the device nameplate and process device tag to verify the approval rating.





1. Flameproof wiring

SIEMENS			
SITRANS LR200		II 1/2 G	HART
7ML1234-56789-0ABC-D		EEx dmia IIC T4	<input type="checkbox"/>
Serial No: GYZ/S1034567		SIRA 05ATEX1001X	Um = 250V
Encl.: NEMA/TYPE 4X, 6, IP67, IP68		CE 0682	
Amb. Temp.: -40°C to 80°C		CE 0518	
Power Rating: 24V, --- Norm., 30V, --- Max., 4-20mA			
Siemens Milltronics Process Instruments Inc., Peterborough			
Made in Canada			

Approval Rating	Valid for:	Reference
ATEX II 1/2 G, EEx dm ia IIC T4	Europe	<i>Flameproof/Increased Safety: ATEX Certificate on page A-1.</i>

- For power demands see *Curve 2 (Flameproof, Increased Safety, Explosion-proof)* on page 23.
- For wiring requirements follow local regulations.
- See also *Instructions specific to hazardous area installations* on page 13 and the ATEX certificate listed above.



2. Increased safety wiring

SIEMENS	
SITRANS LR200 7ML1234-56789-0ABC-D Serial No: GYZ/S1034567 Encl.: NEMA/TYPEx, 6, IP67, IP68 Amb. Temp.: -40°C to 80°C Power Rating: 24V --- Nom. 30V --- Max. 4-20mA Siemens Milltronics Process Instruments Inc., Peterborough Made in Canada	 II 1/2 G EEx emia IIC T4 SIR A 05ATEX1001X 0682 0518  
	HART  Um = 250V

Approval Rating	Valid for:	Reference
ATEX II 1/2 G, EEx em ia IIC T4	Europe	<i>Flameproof/Increased Safety: ATEX Certificate on page A-1.</i>

- For power demands see *Curve 2 (Flameproof, Increased Safety, Explosion-proof)* on page 23.
- For wiring requirements follow local regulations.
- See also *Instructions specific to hazardous area installations* on page 13 and the ATEX certificate listed above.

3. Explosion-proof wiring (FM/CSA US/Canada only)

SIEMENS	
SITRANS LR200 7ML1234-56789-0ABC-D Serial No: GYZ/S1034567 Encl.: NEMA/TYPEx, 6, IP67, IP68 Amb. Temp.: -40°C to 80°C Power Rating: 24V --- Nom. 30V --- Max. 4-20mA Siemens Milltronics Process Instruments Inc., Peterborough Made in Canada	
Class I: Div 1; Group A, B, C, D Class II: Div 1; Group E, F, G Class III Temp. Code: T4 Per drawing: 23650597	 FCC ID: NJA-LR 200 CANADA: 267P-LR 200 HART  159134 WARNING: Do Not Remove Cover While Circuits Are Live

Approval Rating	Valid for:	Reference
FM/CSA: Class I, Div. 1, Groups A, B, C, D Class II, Div. 1, Groups E, F, G Class III T4	US/Canada	FM/CSA Explosion Proof Connection Drawing number 23650597

- For power demands see *Curve 2 (Flameproof, Increased Safety, Explosion-proof)* on page 23.
- For wiring requirements (North America only) see the connection drawing listed above, which can be downloaded from the product page of our website at www.siemens.com/LR200.

4. Non-incendive wiring (FM/US only)

SIEMENS	FM APPROVED	Class I, Div. 2, Group A, B, C, D Temp. Code: T5
7ML1234-56789-0ABC-D Serial No: GYZ / S1034567 Encl.: NEMA / TYPE 4X, 6, IP67 Amb. Temp.: -40 °C to 80 °C Power Rating: 24V \approx Nom., 30V \approx Max., 4-20mA	CANADA: 267P- FCC ID: NJA-LR200	
Siemens Milltronics Process Instruments Inc., Peterborough Made in Canada	This device complies with Part 15 of the FCC Rules. Operation is subject to the following two conditions 1) This device may not cause harmful interference and 2) This device must accept any interference received, including interference that may cause undesired operation	

Approval Rating	Valid for:	Reference
FM: Class I, Div. 2, Groups A, B, C, D T5	US	FM Non-Incendive Connection Drawing number 23650537

- For power demands, see *Curve 1 (General Purpose, Intrinsically Safe, Non-incendive)* on page 23.
- For wiring requirements (North America only) see the connection drawing listed above, which can be downloaded from the product page of our website at www.siemens.com/LR200.

5. Intrinsically Safe wiring

SIEMENS	FM APPROVED	Class I, Div 1, Group A, B, C, D Class II, Div 1, Group E, F, G Class III Temp. Code: T4 HART
SITRANS LR200 7ML1234-56789-0ABC-D Serial No: GYZ / S1034567 Encl.: NEMA / TYPE 4X, 6, IP67, IP68 Amb. Temp.: -40 °C to 80 °C Power Rating: 24V \approx Nom., 30V \approx Max., 4-20mA	Class I, Div 1, Group A, B, C, D Class II, Div 1, Group E, F, G Class III Temp. Code: T4 HART	Vmax = 30 V Imax = 120 mA Pmax = 0.8 W Ci = 15 nF Li = 0.1 mH
Siemens Milltronics Process Instruments Inc., Peterborough Made in Canada	CSA per drawing A5E01003039 IC: 267P-LR200 FM per drawing A5E01003040 FCC ID: NJA-LR200 WARNING: Possible Static Hazard, Do Not Rub Or Clean On Site	

SIEMENS	FM APPROVED	Class I, Div 1, Group A, B, C, D Class II, Div 1, Group E, F, G Class III Temp. Code: T4 HART
SITRANS LR200 7ML1234-56789-0ABC-D Serial No: GYZ / S1034567 Encl.: NEMA / TYPE 4X, 6, IP67, IP68 Amb. Temp.: -40 °C to 80 °C Power Rating: 24V \approx Nom., 30V \approx Max., 4-20mA	Class I, Div 1, Group A, B, C, D Class II, Div 1, Group E, F, G Class III Temp. Code: T4 HART	Vmax = 30 V Imax = 120 mA Pmax = 0.8 W Ci = 15 nF Li = 0.1 mH
Siemens Milltronics Process Instruments Inc., Peterborough Made in Canada	CSA per drawing A5E01003039 IC: 267P-LR200 FM per drawing A5E01003040 FCC ID: NJA-LR200 WARNING: Possible Static Hazard, Do Not Rub Or Clean On Site	

Approval Rating	Valid for:	Reference
FM/CSA: Class I, Div. 1, Groups A, B, C, D Class II, Div. 1, Groups E, F, G Class III	US/Canada	FM Intrinsically Safe Connection Drawing number A5E01003040 CSA Intrinsically Safe Connection Drawing number A5E01003039
ATEX II 1 G, EEx ia IIC T4	Europe	<i>Intrinsically Safe: ATEX Certificate on page A-5</i>
ANZEX Ex ia IIC T4 (Tamb = -40 to 80 °C) IP67	Australia	
IECEX TSA 04.0020X	International	

- For power demands see *Curve 1 (General Purpose, Intrinsically Safe, Non-incendive)* on page 23.

- For wiring requirements:
 - N. America: See the connection drawings listed above, which can be downloaded from the product page of our website at: www.siemens.com/LR200.
 - Europe: Follow local regulations.
 - Australia: Follow local regulations.
 - International: Follow local regulations.
- Use appropriate conduit seals to maintain IP or NEMA rating.
- Recommended intrinsically safe barriers are listed under *Passive Shunt Diode Barriers* on page 12.
- Refer to *Instructions specific to hazardous area installations* on page 13 and the ATEX certificate listed above.

Note: Selecting a suitable PLC input module, power supply, or barrier requires knowledge about Intrinsic Safety and the application. It is the responsibility of the installer to ensure that the intrinsically safe installation complies with both the apparatus approval requirements and the relevant national code of practice.

Passive Shunt Diode Barriers

Note: A well regulated supply voltage is required.

Manufacturer	Part Number
MTL	787SP+ (Dual Channel)
MTL	7787P+ (Dual Channel)
Stahl	9001/01-280-100-10 (Single Channel)
Stahl	9002/01-280-110-10 (Dual Channel)

How to select a passive barrier for SITRANS LR200

To make sure that the barrier safety description is suitable for the LR200 Intrinsically Safe (IS) input parameters, carry out the following calculations:

- Re-e = max. end-to-end resistance of the barrier
- Rloop = loop resistance (total of cable resistance plus e.g. sense resistance, displays, and/or PLC inputs)
- V_{barrier} = value of any non-linear voltage drops due to the barrier

- Determine the value for Re-e from the data sheet.
- Calculate the total value for Rloop: by adding, for example, sense resistance, displays, and/or PLC inputs.
- Calculate R_{working} = Re-e + Rloop.

- 4) Determine the value of V_{barrier} from the barrier data sheet (for example, voltage drops due to diodes).
- 5) Calculate $V_{\text{working}} = V_{\text{supply}} - V_{\text{barrier}}$.

Use the values for V_{working} and R_{working} to confirm that operation is within the shaded area of the graph *Curve 1 (General Purpose, Intrinsically Safe, Non-incendive)* on page 23.

Notes:

- The following list is not exhaustive: there are many IS power supplies and barriers on the market, which will work with the LR200.
- The PLC input modules and barriers listed below have all been tested and are functionally compatible with the LR200.

Active barriers (repeating barriers)

Manufacturer	Part Number
MTL	706
MTL	7206
Stahl	9001/51-280-110-14
Pepperl+Fuchs	KSD2-CI-S-Ex
Pepperl+Fuchs	KFD2-STC3-Ex1
MTL	E02009 - verify
MTL	E02010

Instructions specific to hazardous area installations (Reference European ATEX Directive 94/9/EC, Annex II, 1/0/6)

The following instructions apply to equipment covered by certificate numbers SIRA 06ATEX2378X, SIRA 05ATEX1001X:

- 1) For use and assembly, refer to the main instructions.
- 2) The equipment is certified for use as Category 1G equipment.
- 3) The equipment may be used with flammable gases and vapors with apparatus group IIC, IIB, and IIA, and temperature classes T1, T2, T3, and T4.
- 4) The equipment is certified for use in an ambient temperature range of $-40\text{ }^{\circ}\text{C}$ to $+80\text{ }^{\circ}\text{C}$.
- 5) The equipment has not been assessed as a safety related device (as referred to by Directive 94/9/EC Annex II, clause 1.5).
- 6) Installation and inspection of this equipment shall be carried out by suitably trained personnel in accordance with the applicable code of practice (EN 60079-14 and EN 60079-17 in Europe).

- 7) The equipment is non-repairable.
- 8) The certificate numbers have an 'X' suffix, which indicates that special conditions for safe use apply. Those installing or inspecting this equipment must have access to the certificates.
- 9) If the equipment is likely to come into contact with aggressive substances, then it is the responsibility of the user to take suitable precautions that prevent it from being adversely affected, thus ensuring that the type of protection is not compromised.

Aggressive substances: e.g. acidic liquids or gases that may attack metals, or solvents that may affect polymeric materials.

Suitable precautions: e.g. establishing from the material's data sheet that it is resistant to specific chemicals.

Activating SITRANS LR200

Power up the device. SITRANS LR200 automatically starts up in Measurement mode. (To change the language displayed see *Selecting a listed option (for example, selecting a language)* on page 17.)

The LCD Display

Measurement mode (normal operation)

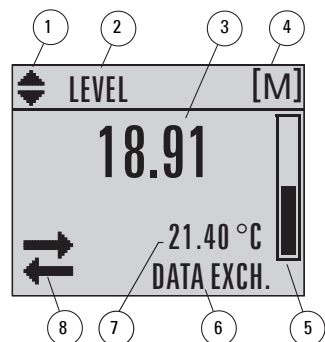

- 1 – toggle indicator for linear units or %
- 2 – selected operation: level, space, or distance
- 3 – measured value (level or volume, space, or distance)
- 4 – units
- 5 – bar graph indicates level
- 6 – secondary region indicates on request¹⁾ electronics temperature, echo confidence, loop current, or distance
- 7 – text area displays status messages
- 8 – device status indicator

Fault present



S: 0 LOE

- 7 – text area displays a fault code and an error message
- 8 – service required icon appears

PROGRAM mode

Navigation view

- A visible menu bar indicates the menu list is too long to display all items.
- A deeper item band represents a shorter menu list.

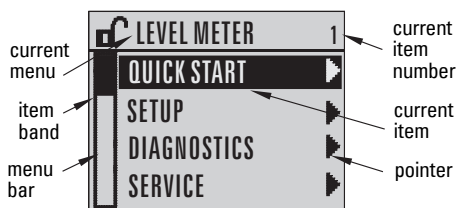

¹⁾ In response to a key press request: see *Key functions in Measurement mode* on page 15.

Parameter view

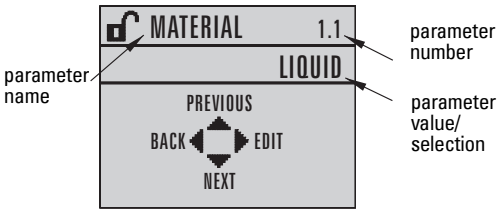

Edit view

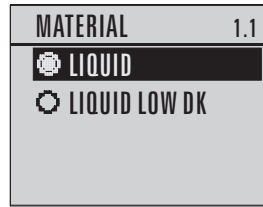

Handheld Programmer



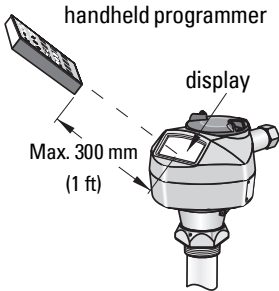

(Part No. 7ML1930-1BK)

The programmer is ordered separately.

- Point the programmer at the display (from a maximum distance of 300 mm [1 ft.]).
- Press  Mode to toggle between Measurement and PROGRAM mode.



Key functions in Measurement mode

Key	Function	Result
	Mode opens PRO-GRAM mode.	Opens the menu level last displayed in this power cycle, or menu level 1 if power has been cycled since exiting PRO-GRAM mode or more than 10 minutes have elapsed since PROGRAM mode was used.
	RIGHT arrow opens PROGRAM mode.	Opens menu level 1.
 	UP or DOWN arrow toggles between linear units and percent.	LCD displays measured value in either linear units or percent.

Key	Function	Result
5	Updates the loop current.	New value is displayed in LCD secondary region.
6	Updates internal enclosure temperature reading.	
8	Updates echo confidence value.	
	Updates distance measurement.	

Programming SITRANS LR200

Note: SITRANS LR200 automatically returns to Measurement mode after a period of inactivity in PROGRAM mode (between 15 seconds and 10 minutes, depending on the menu level).

Settings can be modified locally via the Local User Interface or remotely via SIMATIC PDM. The Local User Interface (LUI) consists of an LCD display and a handheld programmer.

- See *Quick Start Wizard via the handheld programmer* on page 18.
- See *Quick Start Wizard via SIMATIC PDM* on page 21.

Parameter menus

Note: For the complete list of parameters with instructions, see the full manual. It can be downloaded from the product page of our website at www.siemens.com/LR200.

Parameters are identified by name and organized into function groups, then arranged in a 5-level menu structure.







1. QUICK START
2. SETUP
3. DIAGNOSTICS
 - 3.14. MEAS. VALUES
 - 3.14.1. CURR. INTERN. TEMP.

Accessing parameters via the handheld programmer

1. Enter PROGRAM mode





- a) Point the programmer at the display from a maximum distance of 300 mm (1 ft).
- b) Press **RIGHT arrow**  to open menu level 1.

2. Navigating: key functions in Navigation mode

Key	Name	Menu level	Function
 	UP or DOWN arrow	menu or parameter	<ul style="list-style-type: none"> Scroll to previous or next menu or parameter.
	RIGHT arrow	menu	<ul style="list-style-type: none"> Go to first parameter in the selected menu or open next menu.
		parameter	<ul style="list-style-type: none"> Open Edit mode.
	LEFT arrow	menu or parameter	<ul style="list-style-type: none"> Open parent menu.
	Mode	menu or parameter	<ul style="list-style-type: none"> Change to MEASUREMENT mode.
	Home	menu or parameter	<ul style="list-style-type: none"> Open menu level 1.

3. Editing in PROGRAM mode

Selecting a listed option (for example, selecting a language)

- Navigate to **Language (7)**.
- Press **RIGHT arrow**  to open parameter view.
- Press **RIGHT arrow**  again to open **Edit** mode. The current selection is highlighted.
- Scroll to a new selection.
Press **RIGHT arrow**  to accept it. The LCD returns to parameter view and displays the new selection.
- Press **LEFT arrow**  to return to the menu.

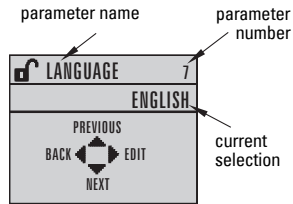

Changing a numeric value

- Navigate to the desired parameter.
- Press **RIGHT arrow**  to open parameter view. The current value is displayed.

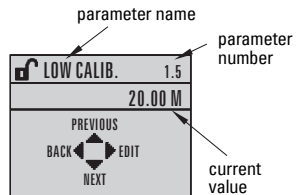



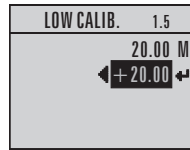





- c) Press **RIGHT arrow**  again to open **Edit** mode. The current value is highlighted.
- d) Key in a new value, and press **RIGHT arrow**  to accept it.



The LCD returns to parameter view and displays the new selection.



Key functions in Edit mode





Key	Name	Function	
 	UP or DOWN arrow	Selecting options	<ul style="list-style-type: none"> • Scrolls to item.
		Numeric editing	<ul style="list-style-type: none"> • Increments or decrements digits • Toggles plus/minus sign
	RIGHT arrow	Selecting options	<ul style="list-style-type: none"> • Accepts the data (writes the parameter) • Changes from Edit to Navigation mode
		Numeric editing	<ul style="list-style-type: none"> • Moves cursor one space to the right • or with cursor on Enter sign, accepts the data and changes from Edit to Navigation mode
	LEFT arrow	Selecting options	<ul style="list-style-type: none"> • Cancels Edit mode without changing the parameter
		Numeric editing	<ul style="list-style-type: none"> • Moves cursor to plus/minus sign if this is the first key pressed • or moves cursor one space to the left.
	Clear	Numeric editing	<ul style="list-style-type: none"> • Erases the display.
	Decimal point	Numeric editing	<ul style="list-style-type: none"> • Enters a decimal point.
	Plus/minus sign	Numeric editing	<ul style="list-style-type: none"> • Changes the sign of the entered value.
 to 	Numeral	Numeric editing	<ul style="list-style-type: none"> • Enters the corresponding character.

Quick Start Wizard via the handheld programmer

Note: Each time the Quick Start Wizard is initiated, the start-up settings are factory defaults. The Wizard will not recall previous user-defined settings.

1. Quick Start

- Point the programmer at the display (from a maximum distance of 300 mm [1 ft.]), then press **RIGHT arrow**  to activate PROGRAM mode and open menu level 1.
- Press **RIGHT arrow**  twice to navigate to menu item 1.1 and open parameter view.

- c) Press **RIGHT arrow**  to open **Edit** mode or **DOWN arrow**  to accept default values and move directly to the next item.
- d) To change a setting, scroll to the desired item or key in a new value.
- e) After modifying a value, press **RIGHT arrow**  to accept it and press **DOWN arrow**  to move to the next item.
- f) Quick Start settings take effect only after you select **Yes** to **Apply changes** in step 1.7.

1.1. Material

Options	LIQUID
	LIQUID LOW DK (low dielectric liquid)

1.2. Response Rate

Sets the reaction speed of the device to measurement changes in the target range.

Options	SLOW	0.1 m/minute
	MED	1.0 m/minute
	FAST	10.0 m/minute

Use a setting just faster than the maximum filling or emptying rate (whichever is greater).

1.3. Sensor Units

Selects the units for the Quick Start variables (high and low calibration point, and level, distance, or space).

Options	M, CM, MM, FT, IN
----------------	-------------------

1.4. Operation

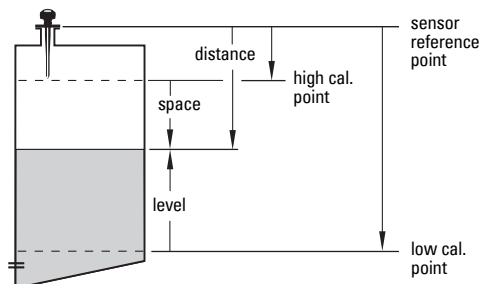

Operation types	NO SERVICE	The SITRANS LR200 stops updating measurements and associated loop current. Last valid measurement is displayed.
	LEVEL	Distance to material surface referenced from Low Calibration Point (process empty level).
	SPACE	Distance to material surface referenced from High Calibration Point (process full level).
	DISTANCE	Distance to material surface referenced from Sensor Reference Point.

1.5. Low Calibration Point

Distance from Sensor Reference to Low Calibration Point: usually process empty level.

Values	Range: 0.0000 to 20.000 m
---------------	---------------------------

1.6. High Calibration Point

Distance from Sensor Reference to High Calibration Point: usually process full level.

Values	Range: 0.0000 to 20.000 m
---------------	---------------------------

1.7. Apply? (Apply changes)





*In order to save the Quick Start settings it is necessary to select **Yes** to apply changes.*

Options	YES, NO
----------------	---------

Display shows **DONE** when Quick Start is successfully completed.

Press **Mode**  to return to Measurement mode. SITRANS LR200 is now ready to operate.

Requesting an Echo Profile

- 1) In PROGRAM mode, navigate to: **Level Meter > Diagnostics (3) > Echo Profile (3.1)**.
- 2) Press **RIGHT arrow**  to request a profile.
- 3) In the Profile screen, press **UP arrow**  to select the **Transmit** icon, and **RIGHT arrow**  to update the profile.
- 4) Press **DOWN arrow**  to select the **Exit** icon, then **RIGHT arrow**  to return to previous menu.

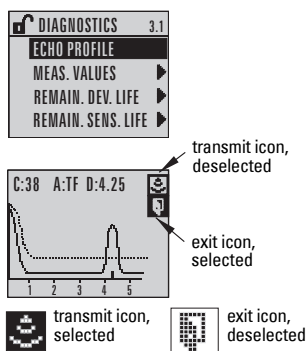

SITRANS LR200 Communications: HART

- You will need the full manual to acquire the list of applicable parameters.
- We recommend that you use SIMATIC Process Device Manager (PDM) to program your device.

SIMATIC PDM

Notes:

- SIMATIC PDM Rev. 6.0 SP3 or higher is recommended.
- SIMATIC PDM Rev. 5.2 SP1 is supported only for basic configuration and troubleshooting. For advanced features such as the Quick Start wizard, Revision 6.0 SP3 or higher is required.

SIMATIC PDM is a software package used to commission and maintain SITRANS LR200 and other process devices. Please consult the operating instructions or online help for details on using SIMATIC PDM. (You can find more information at: www.siemens.com/simatic-pdm. Go to **Products and Solutions > Products and Systems > Communications and Software > Process Device Manager.**)

Electronic Device Description (EDD)

- You can locate the EDD in Device Catalog, under **Sensors/Level/Echo/Siemens Milltronics/SITRANS LR200**.
- Check the product page of our website at: www.siemens.com/LR200, under **Downloads**, to make sure you have the latest version of SIMATIC PDM, the most recent Service Pack (SP) and the most recent hot fix (HF). If you need to install a new EDD see *Configuring a new device* below.

Configuring a new device

Note: Clicking on **Cancel** during an upload from device to SIMATIC PDM will result in some parameters being updated.

1. Check that you have the most recent EDD, and if necessary download it from the product page listed above. Save the files to your computer, and extract the zipped file to an easily accessed location. Launch **SIMATIC PDM – Manager Device Catalog**, browse to the unzipped EDD file and select it.
2. Launch SIMATIC PDM and create a new project for LR200. Application Guides for setting up HART devices with SIMATIC PDM can be downloaded from the product page of our website at: www.siemens.com/LR200.
3. Upload parameters to the PC/PG.
4. Configure the device via the Quick Start wizard (see below).

Quick Start Wizard via SIMATIC PDM

Notes:

- The Quick Start wizard settings are inter-related and changes apply only after you click on **Transfer** at the end of step 5.
- Each time the Quick Start Wizard is initiated, the start-up settings are factory defaults. The Wizard will not recall previous user-defined settings.
- Click on **BACK** to return and revise a setting or **Cancel** to exit the Quick Start.

Launch SIMATIC PDM, open the menu **Device – Quick Start**, and follow steps 1 to 5.

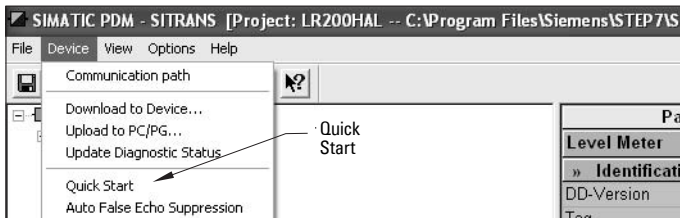

Maintenance

SITRANS LR200 requires no maintenance or cleaning under normal operating conditions. If cleaning becomes necessary under severe operating conditions:

1. Note the antenna material and the process medium, and select a cleaning solution that will not react adversely with either.
2. Remove the device from service and wipe the antenna clean using a cloth and suitable cleaning solution.

Unit Repair and Excluded Liability

For detailed information, please see the inside back cover.

Maximum Process Temperature Chart

! WARNING: Internal temperature must not exceed 80 °C (176 °F).

Maximum Flange and Process Temperatures versus allowable ambient for flange adapter versions of SITRANS LR200

- The chart is for guidance only.
- It does not represent every possible process connection arrangement. For example, it will NOT apply if SITRANS LR200 is mounted directly on a metallic vessel surface.
- It does not take into consideration heating from direct sunshine exposure.
- You can use parameter 3.14.1 to monitor the current internal temperature.

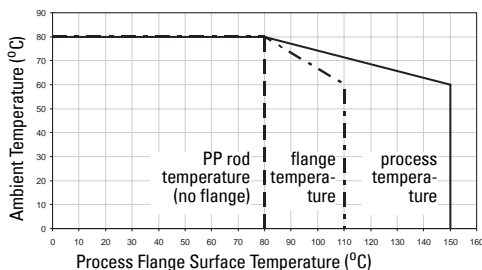

Loop power

Typical connection drawing

Note: Loop voltage is the voltage at the terminals of the power supply (not the voltage at the terminals of the device).

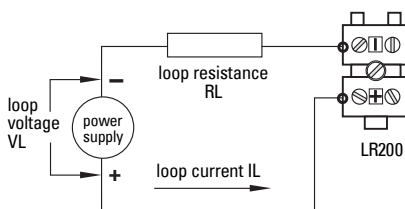

Allowable operating area

Curve 1 (General Purpose, Intrinsically Safe, Non-incendive)

Loop Voltage versus Loop Resistance

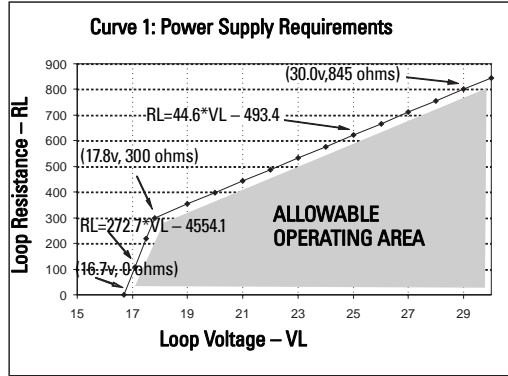

Curve 2 (Flameproof, Increased Safety, Explosion-proof)

Loop Voltage versus Loop Resistance

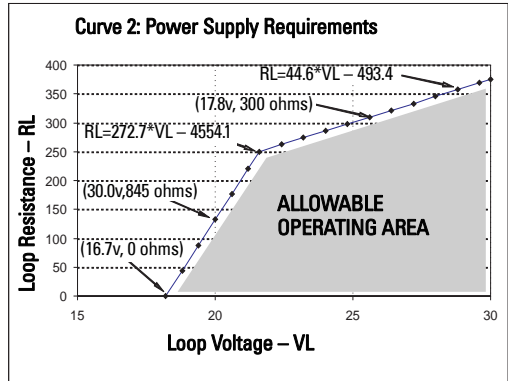

Startup Curve

Note: At startup, it can take anywhere from 25 to 55 seconds for the device to report the actual material level.

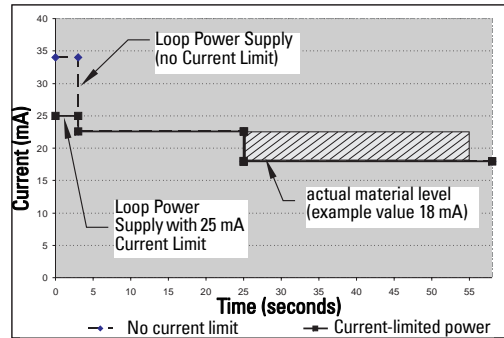

Notes

SITRANS LR200 (HART) med Siemens LBI Interface: Quick Start manual

Denne manual opridser de væsentligste karakteristika og funktioner af SITRANS LR200 (HART). Vi anbefaler Dem kraftigt at anskaffe den detaljerede version af denne manual, så De kan anvende apparatet fuldt ud. Den komplette manual kan downloades fra produktsiden for SITRANS LR200 på vores website: www.siemens.com/LR200. Den trykte manual kan fås hos Deres lokale Siemens Milltronics repræsentant.

Spørgsmål vedrørende indholdet af denne manual kan rettes til:

Siemens Milltronics Process Instruments Inc.
1954 Technology Drive, P.O. Box 4225
Peterborough, Ontario, Canada, K9J 7B1
E-mail: techpubs.smpi@siemens.com

Dansk

**Copyright Siemens Milltronics
Process Instruments Inc. 2008.
Alle rettigheder forbeholdes**

Ansvarsfragøelse

Vi opfordrer brugerne til at anskaffe de autoriserede, indbundne manualer eller læse de elektroniske versioner, der er udarbejdet og skrevet af Siemens Milltronics Process Instruments Inc. Siemens Milltronics Process Instruments Inc. påtager sig intet ansvar for indholdet af delvise eller fuldstændige gengivelser af indbundne eller elektroniske versioner.

Skønt vi har kontrolleret, at indholdet af denne manual stemmer overens med de beskrevne instrumenter, kan der stadig forekomme variationer. Vi kan derfor ikke garantere en fuldstændig overensstemmelse. Indholdet af denne manual revideres jævnligt, og eventuelle rettelser inkluderes i de efterfølgende udgaver. Vi modtager gerne forslag til forbedringer.

Retten til ændringer af de tekniske data forbeholdes.

MILLTRONICS er et registreret varemærke, der tilhører Siemens Milltronics Process Instruments Inc.

Teknisk Support

Support er tilgængelig 24 timer i døgnet.

Adresse, telefon- og faxnummer på Siemens Automations lokale kontor kan findes på:

www.siemens.com/automation/partner:

- Klik på fanebladet **Contacts by Product** (*Kontakter pr. produkt*) og find den relevante produktgruppe (**+Process Automation** (*Procesautomatisering*) > **+Process Instrumentation** (*Procesinstrumentering*) > **+Level Measuring Instruments** (*Niveaumålingsinstrumenter*)).
- Vælg teamet **Technical Support** (*Teknisk assistance*). Klik på **Next** (*Næste*).
- Klik på et kontinent, derefter et land og til slut en by. Klik på **Next**.

For on-line teknisk support, gå til: www.siemens.com/automation/support-request

- Indtast apparatets navn (SITRANS LR200) eller ordrenummeret, klik på **Search** (*Søg*) og vælg den relevante produkttype. Klik på **Next**.
- Indtast et nøgleord, der beskriver problemet. Gennemløb derefter den relevante dokumentation eller klik på **Next** for at e-maile en beskrivelse af problemet til personalet i Siemens Tekniske Support.

Siemens A&D Technical Support Center:

telefon +49 180 50 50 222

fax +49 180 50 50 223

Sikkerhedsvejledning

De anførte advarsler skal overholdes for at sikre egen og andres sikkerhed samt for at beskytte produktet og det tilknyttede udstyr. Advarslerne ledsages af en tydeliggørelse af graden af forsigtighed, der bør overholdes.



ADVARSEL: vedrører et advarselssymbol på produktet og betyder, at en manglende overholdelse af de nødvendige forholdsregler kan føre til død, alvorlig personskade og/eller omfattende materielle skader.



ADVARSEL¹⁾: betyder, at en manglende overholdelse af de nødvendige forholdsregler kan føre til død, alvorlig personskade og/eller omfattende materielle skader.

Bemærk: betyder vigtige oplysninger om produktet eller denne del af brugsvejledningen.

FCC-overensstemmelse

Kun for installationer i USA: Regler fra Federal Communications Commission (FCC)



ADVARSEL: Ændringer eller modifikationer, der ikke er udtrykkeligt godkendt af Siemens Milltronics, kan ophæve brugerens ret til at benytte udstyret.

Bemærkninger:

- Dette udstyr er blevet testet og fundet at overholde grænserne for et klasse A digitalt udstyr i henhold til Afsnit 15 i FCC-reglerne. Disse grænser er beregnet til at yde en rimelig beskyttelse mod skadelige interferenser, når udstyret anvendes i kommercielle omgivelser.
- Dette udstyr frembringer, bruger og kan udstråle radiofrekvent energi, og kan, såfremt det ikke installeres og bruges i overensstemmelse med instruktionsbogen, forårsage interferens, der kan virke forstyrrende for radiokommunikationen. Brugen af dette udstyr i et beboelsesområde vil sandsynligvis forårsage skadelig interferens med radiokommunikationer, som brugeren i givet fald vil være nødsaget til at udbedre for egen regning.

SITRANS LR200



ADVARSEL: SITRANS LR200 bør kun anvendes som beskrevet i denne manual, da den beskyttelse, udstyret yder, ellers kan forringes.

Bemærk: Dette produkt er beregnet til anvendelse i industriområder. Brugen af dette udstyr i et beboelsesområde kan forårsage interferens med forskellige frekvensbaserede kommunikationer.

SITRANS LR200 er en totråds 6 GHz pulsradarniveautransmitter til kontinuert overvågning af væsker og opslæmninger i lager- og processtanke, inklusive ved højt tryk og høj temperatur, i en afstand af op til 20 m (66 ft).

Dette apparat består af et elektronisk kredsløb, der er koblet til antennen, og en processtilslutning af enten gevind- eller flangetypen.

¹⁾ Dette symbol anvendes, når der ikke er noget tilsvarende advarselssymbol på produktet.

Kommunikationen foregår via HART.¹⁾ Signaler behandles ved hjælp af Process Intelligence.

Tekniske data

For en fuldstændig liste, se SITRANS LR200 (HART) Instruktionsbogen. For oplysninger om godkendelser henvises der til apparatets typeskilt og procesudstyrskilt.

Omgivende temperatur/Driftstemperatur

Bemærkninger:

- De tilladte procestemperaturer og –tryk afhænger af oplysningerne på procesudstyrskiltet. Referencetegningen, der er angivet på dette skilt, kan downloades fra Siemens' website på: www.siemens.com/LR200.
- Den maksimale temperatur afhænger af procestilslutningen, antennematerialerne og trykket i beholderen. Se *Diagram over maksimale procestemperaturer* på side 22 for yderligere detaljer. Kurver over procestryk- og temperaturreduktionen findes i den komplette manual.

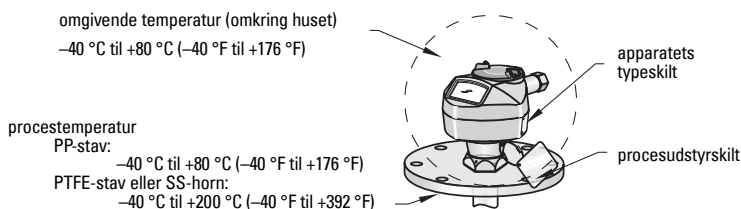

Strømforsyning



Almen brug:
Ikke-antændingsfarlig (kun FM/US):
Egensikker:



Flammesikker:
Forhøjet sikkerhed:
Eksplosionssikker (kun FM/CSA US/Canada):

Nominal 24 V dc med
max. 550 Ohm
sløjfemodstand.

Nominal 24 V dc med
max. 250 Ohm
sløjfemodstand.

Godkendelser

- Almen brug CSA_{US/C}, FM, CE
- Radio Europa (R&TTE), FCC, Industry Canada

(fortsættes på næste side)

¹⁾ HART[®] er et registreret varemærke, der tilhører HART Communication Foundation.

- Risikoområder Flammesikker (Europa)¹⁾ ATEX II 1/2 G, EEx dm ia IIC T4
 Forhøjet sikkerhed (Europa)²⁾ ATEX II 1/2 G, EEx em ia IIC T4
 Eksplosionssikker (USA/Canada)³⁾ FM/CSA: (barriere ikke påkrævet)
 Klasse I, Div. 1, Gruppe A, B, C, D
 Klasse II, Div. 1, Gruppe E, F, G
 Klasse III T4

Bemærk: Brug passende kabelrørstætninger for at bevare IP- eller NEMA-klassificeringen.

Godkendelser (fortsat)

- Risikoområder
 - Ikke-antændingsfarlig (USA)⁴⁾ FM: (barriere ikke påkrævet)
 Klasse I, Div. 2, Gruppe A, B, C, D T5
 - Egensikker⁵⁾
 - (Europa) ATEX II 1 G, EEx ia IIC T4
 - (USA/Canada) FM/CSA: (barriere påkrævet)
 Klasse I, Div. 1, Gruppe A, B, C, D
 Klasse II, Div. 1, Gruppe E, F, G
 Klasse III T4
 - (Australien) ANZEX Ex ia IIC T4
 (Tomg = -40 til +80 °C) IP67
 - (Internationalt) IECEx TSA 04.0020X T4
- Maritimt Lloyd's Skibsregister
 ABS Typegodkendelse

Programmeringsenhed (infrarødt tastatur)

Siemens Milltronics infrarøde IS (Intrinsically Safe - Egensikre) håndholdte programmeringsenhed til risikoområder og alle andre steder (batteriet kan ikke udskiftes men har en forventet levetid på 10 år ved normal brug).

- godkendelse ATEX II 1 G, EEx ia IIC T4, certifikat SIRA 01ATEX2147
 FM/CSA: Klasse I, Div. 1, Gruppe A, B, C, D
- omgivende temperatur -20 til 40 °C (-5 til 104 °F)
- interface proprietært infrarødt pulssignal
- strømforsyning 3 V lithiumbatteri
- vægt 150 g (0,3 lb)
- farve sort
- Del nummer 7ML1930-1BK

¹⁾ Se *Flammesikker elinstallation* på side 9.

²⁾ Se *Elinstallation med forhøjet sikkerhed* på side 10.

³⁾ Se *Eksplosionssikker elinstallation (kun FM/CSA US/Canada)* på side 10.

⁴⁾ Se *Ikke-antændingsfarlig elinstallation (kun FM/US)* på side 11.

⁵⁾ Se *Egensikker elinstallation* på side 11.

Anvendelser under tryk



- **ADVARSLER:**
- Dette produkt betegnes som trykbærende udstyr i henhold til direktivet 97 / 23 / EF og er ikke beregnet til brug som sikkerhedsanordning.
- Forsøg aldrig at løsne, afmontere eller adskille processtilslutningen eller instrumenthuset, mens indholdet er under tryk.
- Ukorrekt installation kan medføre tab af procestryk.

Installation



- **ADVARSLER:**
- Installationen må kun foretages af kvalificeret personale og under overholdelse af de lokalt gældende regler.
- Konstruktionsmaterialerne er valgt på basis af deres kemiske kompatibilitet (eller inert) ved almindelig brug. Hvis de skal udsættes for særlige omgivelser, bør foreneligheden kontrolleres i tabeller over kemisk kompatibilitet inden installationen.

Bemærkninger:

- Procesudstyrskiltet skal forblive sammen med grænsefladen til procestrykket¹⁾. Såfremt apparatpakken udskiftes, skal procesudstyrskiltet overføres til erstatningsenheden.
- SITRANS LR200 enhederne er hydrostatisk testet og opfylder eller er bedre end kravene i ASME Boiler and Pressure Vessel Code samt det europæiske Trykudstyrsdirektiv.

Installationsvejledning

- Sørg for en lettilgængelig adgang for aflæsning af displayet og programmering ved hjælp af den håndholdte programmeringsenhed.
- Sørg for, at omgivelserne svarer til instrumenthusets klassificering og konstruktionsmaterialer.
- Hvis apparatet skal monteres i direkte sollys, bør det forsynes med en solafskærmning.

¹⁾ Grænsefladen til procestrykket omfatter de komponenter, der fungerer som en barriere mod tryktab fra processtanken: det vil sige kombinationen af processtilslutningsdelen og emitteren, men normalt eksklusiv den elektriske indkapsling.

Mundstykkets udformning

Bemærkninger:

- For mundstykker, der er 100 mm (4") lange eller derunder, bruges 100 mm (4") afskærmningen.
- For mundstykker, der er 250 mm (10") lange eller derunder, bruges 250 mm (10") afskærmningen.
- For detaljer om andre anvendelser henvises der til den komplette manual.

- Enden af afskærmningsdelen skal rage mindst 10 mm (0,4") frem for at undgå, at falske ekko tilbagekastes fra mundstykket.

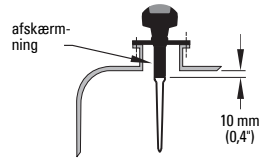

Placering på et mandehulsdæksel

- Et mandehulsdæksel er typisk et tildækket mundstykke med en diameter på 610 mm (24") eller derover.
- For optimale signalbetingelser bør antennen placeres decentreret, typisk 100 mm (4") fra kanten.

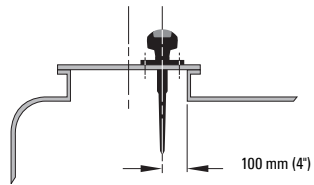

Mundstykkets placering

! ADVARSEL: For beholdere med konisk eller parabolisk top bør det undgås at montere instrumentet i centrum. (Toppens hvælning kan fokusere ekkoerne i centrum, hvilket kan føre til fejlagtige aflæsninger.)

Bemærk: Under visse betingelser kan det være acceptabelt at montere apparatet i centrum af en tank med flad top. Dette bør diskuteres med Deres lokale Siemens repræsentant.

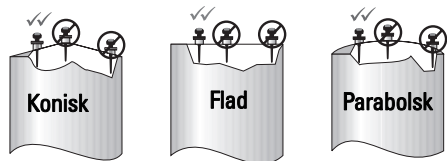

✓ foretrukket ⊘ uønskelig

- Emissionskeglen skal holdes fri for interferens fra stiger, rør, I-profiler eller påfyldningsstrømme.
- Anbring antennen i en vis afstand fra sidevæggene for at undgå indirekte ekko.
- Der skal tages højde for emissionskeglens spredning for at undgå interferens med tankens vægge eller forhindringer.

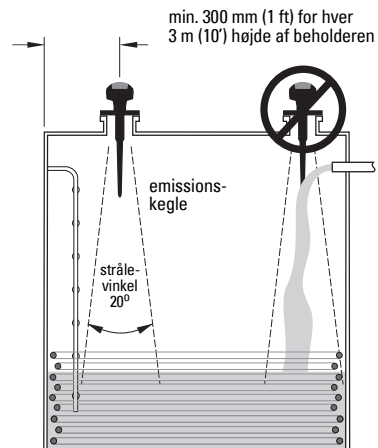

Installationsvejledning

Bemærkninger:

- Der er ingen begrænsning for antallet af gange, apparatet kan drejes.
- Apparatet kan vendes med for- eller bagsiden mod den nærmeste beholdervæg.
- Instrumenthuset bør ikke drejes, efter at apparatet er programmeret og konfigureret (en forskydning af sendeimpulsens polaritet kan føre til fejl).

Version med gevind

- 1) Inden apparatet indsættes i montagetilslutningen, skal det kontrolleres, at gevindene passer sammen, for at undgå at beskadige dem.
- 2) Apparatet skrues på procestilslutningen og strammes med håndkraft. For anvendelser under tryk skal der bruges PTFE-tape eller et andet passende middel til tætning af gevind, og procestilslutningen skal strammes mere end med håndkraft (max. moment 40 Nm (30 ft.lbs)).
- 3) For at dreje instrumenthuset skal de tre stopskruer, der holder låseringen, først løsnes. Når huset sidder rigtigt, strammes skruerne igen.



Version med flange



ADVARSEL: Brugeren er ansvarlig for at vælge sammenboltungs- og pakningsmaterialer, der ligger inden for flangens begrænsninger og dens påtænkte anvendelse, og som passer til anvendelsesforholdene.

Elektrisk installation

Strømforsyning

ADVARSLER:



DC-indgangsklemmerne skal forsynes fra en kilde, der yder elektrisk isolation mellem ind- og udgang, for at opfylde de gældende sikkerhedskrav i henhold til IEC 61010-1.



Alle felt-elinstallationer skal være forsynet med en passende isolering i forhold til de nominelle spændinger.

Tilslutning af SITRANS LR200



ADVARSLER:

- Tjek godkendelsesniveauet på instrumentets typeskilt og procesudstyrskiltet.
- Brug passende kabelrørstætninger for at bevare IP- eller NEMA-klassificeringen.
- Læs *Særlige anvisninger vedrørende installation i risikoområder* på side 13.

Bemærkninger:

- For detaljerede anvisninger om elinstallationen henvises der til den komplette instruktionsbog.
- Brug parsnoet kabel: trådtykkelse AWG 22 til 14 (0,34 mm² til 2,5 mm²).
- Separate kabler og kabelrør kan være nødvendige for at overholde standardmetoderne for elinstallation eller de elektriske normer.

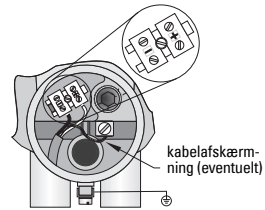
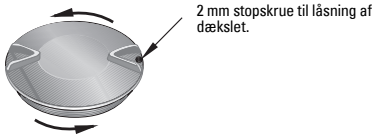

- 1) Brug en 2 mm unbrakonøgle til at løsne den stopskruer, der låser dækslet, og skru derefter dækslet af.
- 2) Afisolér kablet på ca. 70 mm (2,75") fra enden af kablet og før ledningerne gennem kabelafslutningen.
- 3) Forbind ledningerne med klemmen som vist: polariteten er angivet på klemrækken.
- 4) Jordforbind apparatet i henhold til de lokale bestemmelser.
- 5) Stram bøsningen for at opnå en god tætning.
- 6) Luk dækslet og fastgør låseringen inden programmering og konfiguration af apparatet. Undgå at dreje apparatet efter konfigurationen, da dette kan give anledning til fejl.

Tilslutning af HART: typisk PLC/mA konfiguration

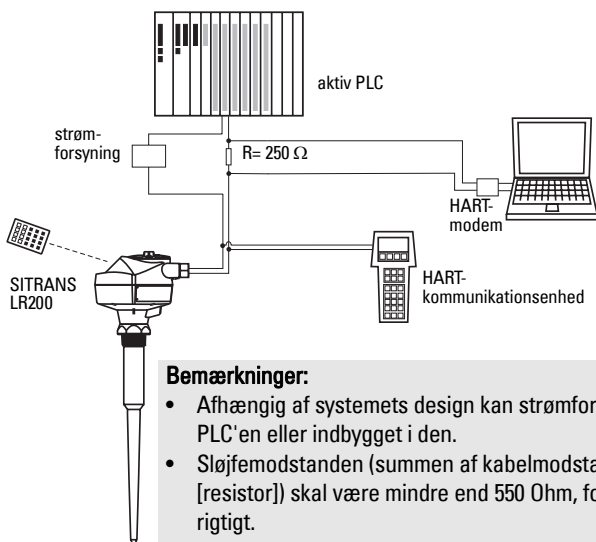

Elektriske opsætninger ved installationer i risikoområder

Bemærk: Nedenstående ATEX-certifikater og forbindelsesdiagrammer kan downloades fra produktsiden på vores website på: www.siemens.com/LR200.

Der findes fem muligheder for elinstallation i risikoområder. Tjek i alle tilfælde godkendelsesniveauet på instrumentets typeskilt og procesudstyrskiltet.



1. Flammesikker elinstallation

SIEMENS		II 1/2 G		HART	
SITRANS LR200		EEx dmia IIC T4		Um = 250V	
7ML1234-56789-0ABC-D		SIRA 05ATEX1001X		0682	
Serial No: GYZ/S1034567		0518		0518	
Encl.: NEMA/TYPE 4X, 6, IP67, IP68		CE		Ⓢ	
Amb. Temp.: -40°C to 80°C		⚠			
Power Rating: 24V --- Norm., 30V --- Max., 4-20mA					
Siemens Milltronics Process Instruments Inc., Peterborough					
Made in Canada					

Godkendelsesniveau	Gælder for:	Reference
ATEX II 1/2 G, EEx dm ia IIC T4	Europa	<i>Flameproof/Increased Safety: ATEX Certificate</i> på side A-1.

- For strømbehov, se *Kurve 2 (Flammesikker, Forhøjet sikkerhed, Eksplosionssikker)* på side 23.
- Mht. kravene til elinstallationen, følg de lokale bestemmelser.
- Se også *Særlige anvisninger vedrørende installation i risikoområder* på side 13 og ovenstående ATEX-certifikat.



2. Einstallation med forhøjet sikkerhed

SIEMENS					II 1/2 G EEx emia IIC T4	HART <input type="checkbox"/>
SITRANS LR200 7ML1234-56789-0ABC-D SerialNo: GYZ/S1034567 Encl.: NEMA/TYPEx 4X, 6, IP67, IP68 Amb. Temp.: -40°C to 80°C Power Rating: 24V --- Nom. 30V --- Max. 4-20mA Siemens Milltronics Process Instruments Inc., Peterborough Made in Canada					SIRA 05ATEX1001X	Um = 250V

Godkendelsesniveau	Gælder for:	Reference
ATEX II 1/2 G, EEx em ia IIC T4	Europa	<i>Flameproof/Increased Safety: ATEX Certificate</i> på side A-1.

- For strømbehov, se *Kurve 2 (Flammesikker, Forhøjet sikkerhed, Eksplosionssikker)* på side 23.
- Mht. kravene til elinstallationen, følg de lokale bestemmelser.
- Se også *Særlige anvisninger vedrørende installation i risikoområder* på side 13 og ovenstående ATEX-certifikat.

3. Eksplosionssikker elinstallation (kun FM/CSA US/Canada)

SIEMENS					Class I: Div 1; Group A, B, C, D Class II: Div 1; Group E, F, G Class III Temp. Code: T4 Per drawing: 23650597	FCC ID: NJA-LR 200 CANADA: 267P-LR 200 HART <input type="checkbox"/>
SITRANS LR200 7ML1234-56789-0ABC-D SerialNo: GYZ/S1034567 Encl.: NEMA/TYPEx 4X, 6, IP67, IP68 Amb. Temp.: -40°C to 80°C Power Rating: 24V --- Nom. 30V --- Max. 4-20mA Siemens Milltronics Process Instruments Inc., Peterborough Made in Canada					WARNING: Do Not Remove Cover While Circuits Are Live	

Godkendelsesniveau	Gælder for:	Reference
FM/CSA: Klasse I, Div. 1, Gruppe A, B, C, D Klasse II, Div. 1, Grupper E, F, G Klasse III T4	USA/Canada	FM/CSA eksplosionssikkert forbindelsesdiagram nummer 23650597

- For strømbehov, se *Kurve 2 (Flammesikker, Forhøjet sikkerhed, Eksplosionssikker)* på side 23.
- For kravene til elinstallationen (kun Nordamerika) se ovenstående forbindelsesdiagram, som kan downloades fra produktsiden på vores website på: www.siemens.com/LR200.

4. Ikke-antændingsfarlig elinstallation (kun FM/US)

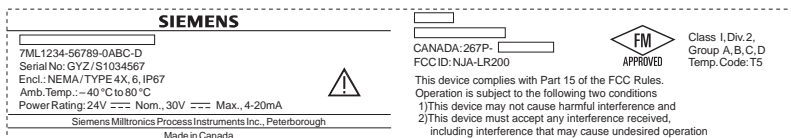

Godkendelsesniveau	Gælder for:	Reference
FM: Klasse I, Div. 2, Grupper A, B, C, D T5	USA	FM Ikke-antændingsfarligt forbindelsesdiagram nummer 23650537

- For strømbehov, se *Kurve 1 (Almen brug, Egensikker, Ikke-antændingsfarlig)* på side 23.
- For kravene til elinstallationen (kun Nordamerika) se ovenstående forbindelsesdiagram, som kan downloades fra produktsiden på vores website på: www.siemens.com/LR200.

5. Egensikker elinstallation

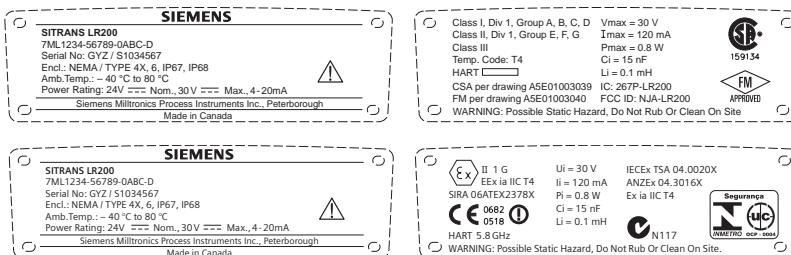

Godkendelsesniveau	Gælder for:	Reference
FM/CSA: Klasse I, Div. 1, Gruppe A, B, C, D Klasse II, Div. 1, Gruppe E, F, G Klasse III	USA/Canada	FM Egensikkert forbindelsesdiagram nummer A5E01003040 CSA Egensikkert forbindelsesdiagram nummer A5E01003039
ATEX II 1 G, EEx ia IIC T4	Europa	<i>Intrinsically Safe: ATEX Certificate</i> på side A-5
ANZEX Ex ia IIC T4 (Tomg = -40 til 80 °C) IP67	Australien	
IECEX TSA 04.0020X	Internationalt	

- For strømbehov, se *Kurve 1 (Almen brug, Egensikker, Ikke-antændingsfarlig)* på side 23.

- Mht. kravene til elinstallationen:
 - Nordamerika: Se ovenstående forbindelsesdiagrammer, der kan downloades fra produktsiden på vores website på: www.siemens.com/LR200.
 - Europa: Følge de lokale bestemmelser.
 - Australien: Følge de lokale bestemmelser.
 - Internationalt: Følge de lokale bestemmelser.
- Brug passende kabelrørstætninger for at bevare IP- eller NEMA-klassificeringen.
- Anbefalede egensikre barrierer er angivet under *Passive barrierer med shunt diode* på side 12.
- Se også *Særlige anvisninger vedrørende installation i risikoområder* på side 13 og ovenstående ATEX-certifikat.

Bemærk: Valget af egnet PLC-inputmodul, strømforsyning eller barriere kræver kendskab til egensikkerhed og applikationen. Det påhviler installatøren at sørge for, at den egensikre installation overholder både apparatets godkendelseskrav og de relevante nationale standarder.

Passive barrierer med shunt diode

Bemærk: Der kræves en velreguleret forsyningssspænding.

Fabrikant	Delnummer
MTL	787SP+ (Dobbelt kanal)
MTL	7787P+ (Dobbelt kanal)
Stahl	9001/01-280-100-10 (Enkelt kanal)
Stahl	9002/01-280-110-10 (Dobbelt kanal)

Hvordan vælges en passiv barriere for SITRANS LR200?

For at sikre sig, at barrierens sikkerhedsbeskrivelse passer til inputparametrene for LR200 Egensikker (IS), udføres følgende beregninger:

- Re-a = barrierens maksimale modstand fra ende til anden
- Rsløjfe = sløjfemodstand (summen af kabelmodstand plus f.eks. sense-modstand, displays og/eller PLC-inputs)
- Vbarriere = værdi af eventuelle ikke-lineære spændingsfald forårsaget af barrieren

- 1) Bestem værdien af Re-a ud fra databladet.
- 2) Beregn den totale værdi af Rsløjfe ved at addere for eksempel sense-modstand, displays og/eller PLC-inputs.
- 3) Beregn Rarbejde = Re-a + Rsløjfe.

- 4) Bestem værdien af Vbarriere ud fra barrierens datablad (for eksempel spændingsfald forårsaget af dioder).
- 5) Beregn Varbejde = Vforsyning – Vbarriere.

Brug værdierne af Varbejde og Rarbejde til at bekræfte, at driften ligger inden for det skraverede område på grafen *Kurve 1 (Almen brug, Egensikker, Ikke-antændingsfarlig)* på side 23.

Bemærkninger:

- Følgende liste er ikke udtømmende: der er mange IS strømforsyninger og barrierer på markedet, som virker sammen med LR200.
- De nedenfor opgivne PLC-inputmoduler og barrierer er alle blevet testet og er funktionelt kompatible med LR200.

Aktive barrierer (gentagende barrierer)

Fabrikant	Delnummer
MTL	706
MTL	7206
Stahl	9001/51-280-110-14
Pepperl+Fuchs	KSD2-CI-S-Ex
Pepperl+Fuchs	KFD2-STC3-Ex1
MTL	E02009 - tjek
MTL	E02010

Særlige anvisninger vedrørende installation i risikoområder

(Reference: det europæiske ATEX Direktiv 94/9/EF, Bilag II, 1/0/6)

Følgende anvisninger gælder for udstyr, der er dækket af certifikat nummer SIRA 06ATEX2378X, SIRA 05ATEX1001X:

- 1) Hvad angår brug og montage, henvises der til de generelle anvisninger.
- 2) Dette udstyr er godkendt til brug som Kategori 1G udstyr.
- 3) Dette udstyr kan anvendes med brændbare gasser og dampe sammen med apparater af gruppe IIC, IIB og IIA og temperaturklasserne T1, T2, T3 og T4.
- 4) Dette udstyr er godkendt til brug i et interval af omgivende temperatur fra -40 °C til +80 °C.
- 5) Dette udstyr vurderes ikke som en sikkerhedsanordning (ifølge direktivet 94/9/EF Bilag II, paragraf 1.5).
- 6) Installationen og inspektionen af dette udstyr skal udføres af tilstrækkeligt uddannet personale i henhold til de gældende normer (EN 60079-14 og EN 60079-17 i Europa).

- 7) Dette udstyr kan ikke repareres.
- 8) Certifikatnumrene ender på "X," hvilket angiver, at der gælder særlige betingelser for en sikker anvendelse. De personer, der skal installere eller inspicere dette udstyr, skal have adgang til certifikaterne.
- 9) Hvis det er sandsynligt, at udstyret vil komme i kontakt med aggressive stoffer, påhviler det brugeren at træffe egnede foranstaltninger for at undgå, at det påvirkes i skadelig retning, for således at sikre, at denne type beskyttelse ikke bringes i fare.

Aggressive stoffer: fx. væske- eller gasformige syrer, der kan angribe metaller, eller opløsningsmidler, der kan påvirke polymere materialer.

Egnede forholdsregler: fx. godtgørelse ud fra materialets datablad af, at det er modstandsdygtigt over for specifikke kemikalier.

Aktivering af SITRANS LR200

Tænd for apparatet. SITRANS LR200 starter automatisk i Målingsmode. (For at ændre displaysproget, se *Valg af en valgmulighed i en liste (for eksempel valg af sprog)* på side 17.)

LCD-display

Målingsmode (normal drift)

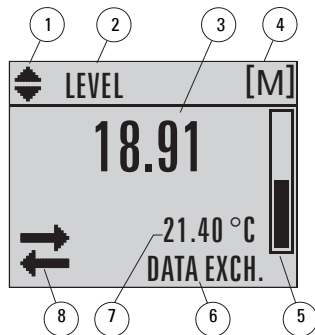

1 – indikator for skift mellem lineære enheder og %

2 – den valgte drift: level (*niveau*), space (*frirum*) eller distance (*afstand*)

3 – den målte værdi (niveau eller rumfang, frirum eller afstand)

4 – enheder

5 – søjlediagram, der angiver niveauet

6 – sekundær zone, der på forespørgsel¹⁾ angiver temperaturen af elektronikken, ekkokonfidensen, sløjfestrømmen eller afstanden

7 – tekstzone, der viser statusmeddelelser

8 – apparatets statusindikator

Ved fejl



S: 0 LOE

7 – tekstzone, der viser en fejlkode og en fejlmeddelelse

8 – ikon for "service påkrævet" vises

PROGRAM mode

Navigationsskærm

- En synlig menüsøjle er tegn på, at menulisten er for lang til, at alle punkterne kan vises.
- Et bredere bånd betyder en kortere menuliste.

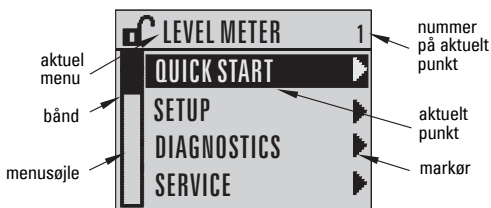

¹⁾ Som svar på en forespørgsel ved tryk på en tast: se *Tasternes funktioner i Målingsmode* på side 15.

Parameterskærm

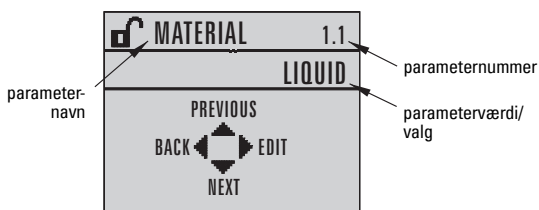

Redigeringskærm

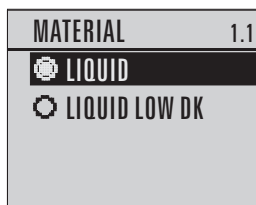

Håndholdt programmeringsenhed

(Del nr. 7ML1930-1BK)



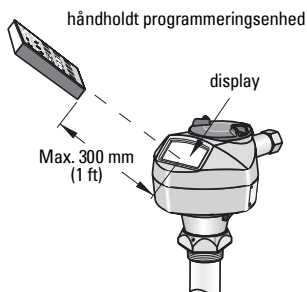

Programmeringsenheden bestilles separat.

- Ret programmeringsenheden mod displayet (fra en afstand af max. 300 mm [1 ft]).
- Tryk på Mode for at skifte mellem Målingsmode og PROGRAM mode.



Tasternes funktioner i Målingsmode

Tast	Funktion	Resultat
	Mode åbner PROGRAM mode.	Åbner det menuniveau, der senest er vist i indeværende tilslutningsperiode, eller menuniveau 1, hvis strømmen har været slået fra siden udgangen fra PROGRAM mode, eller der er gået mere end 10 minutter siden sidste anvendelse af PROGRAM mode.
	HØJRE pil åbner PROGRAM mode.	Åbner menuniveau 1.
 	OP eller NED pilen skifter mellem lineære enheder og procenter.	Displayet viser den målte værdi i lineære enheder eller procenter.

Tast	Funktion	Resultat
	Opdaterer sløjfestrømmen.	Den nye værdi vises i displayets sekundære zone.
	Opdaterer aflæsningen af den interne temperatur i huset.	
	Opdaterer værdien af ekkokonfidensen.	
	Opdaterer afstandsmålingen.	

Programmering af SITRANS LR200

Bemærk: SITRANS LR200 vender automatisk tilbage til Målingsmode efter en periode uden aktivitet i PROGRAM mode (mellem 15 sekunder og 10 minutter afhængigt af menuniveauet).

Indstillingerne kan ændres lokalt ved hjælp af det Lokale Bruger Interface eller ved fjernbetjening ved hjælp af SIMATIC PDM. Det Lokale BrugerInterface (LBI) består af et LCD-display og en håndholdt programmeringsenhed.

- Se *Quick Start guide via den håndholdte programmeringsenhed* på side 18.
- Se *Quick Start guide via SIMATIC PDM* på side 21.

Parametermenuer

Bemærk: For en fuldstændig liste over parametrene med instruktioner henvises der til den komplette manual. Den kan downloades fra produksiden på vores website på: www.siemens.com/LR200.

Parametrene identificeres ved deres navn og er organiseret i funktionsgrupper og derefter i en menustruktur med 5 niveauer.





1. QUICK START
2. SETUP
3. DIAGNOSTICS
 - 3.14. MEAS. VALUES
 - 3.14.1. CURR. INTERN. TEMP.

Adgang til parametre via den håndholdte programmeringsenhed

1. Åbning af PROGRAM mode.

- a) Ret programmeringsenheden mod displayet fra en afstand af max. 300 mm (1 ft).
- b) Tryk på **HØJRE pil**  for at åbne menuniveau 1.

2. Navigation: tasternes funktioner i Navigationsmode

Tast	Navn	Menuniveau	Funktion
	OP eller NED pil	menu eller parameter	<ul style="list-style-type: none"> Rul til forrige eller næste menu eller parameter.
	HØJRE pil	menu	<ul style="list-style-type: none"> Gå til første parameter i den valgte menu eller åbn næste menu.
		parameter	<ul style="list-style-type: none"> Åbn Redigeringsmode.
	VENSTRE pil	menu eller parameter	<ul style="list-style-type: none"> Åbn forældremenuen.
	Mode	menu eller parameter	<ul style="list-style-type: none"> Skifter til MÅLINGSMODE.
	Hjem	menu eller parameter	<ul style="list-style-type: none"> Åbner menuniveau 1.

3. Redigering i PROGRAM mode

Valg af en valgmulighed i en liste (for eksempel valg af sprog)

- a) Navigér hen til **Language (Sprog) (7)**.

- b) Tryk på **HØJRE pil**  for at åbne parameterskærmen.

- c) Tryk en gang til på **HØJRE pil**  for at åbne **Redigeringsmode**. Det aktuelle valg fremhæves.

- d) Rul hen til et nyt valg.

Tryk på **HØJRE pil**  for at acceptere værdien. Displayet vender tilbage til parameterskærmen og viser det nye valg.

- e) Tryk på **VENSTRE pil**  for at vende tilbage til menuen.

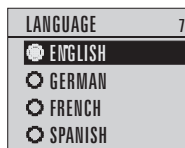
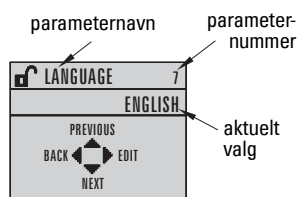



Ændring af en numerisk værdi

- a) Navigér hen til den ønskede parameter.

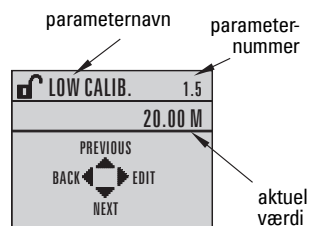



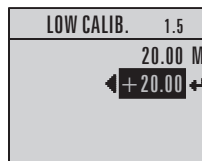

- b) Tryk på **HØJRE pil**  for at åbne parameterskærmen. Den aktuelle værdi vises.



- c) Tryk en gang til på **HØJRE pil**  for at åbne **Redigeringsmode**. Den aktuelle værdi fremhæves.
- d) Indtast den nye værdi og tryk på **HØJRE pil**  for at acceptere den.
- Displayet vender tilbage til parameterskærmen og viser det nye valg.





Tasternes funktioner i Redigeringsmode

Tast	Navn	Funktion	
	OP eller NED pil	Valg af valgmuligheder	<ul style="list-style-type: none"> Ruller hen til punkt
		Talredigering	<ul style="list-style-type: none"> Inkrementerer eller dekrementerer tal Skifter mellem plus- og minustegn
	HØJRE pil	Valg af valgmuligheder	<ul style="list-style-type: none"> Accepterer data (skriver til parameteren) Skifter fra Redigerings- til Navigationsmode
		Talredigering	<ul style="list-style-type: none"> Flytter cursoren én plads mod højre eller med cursoren på tegnet Enter, accepterer data og skifter fra Redigerings- til Navigationsmode
	VENSTRE pil	Valg af valgmuligheder	<ul style="list-style-type: none"> Annullerer Redigeringsmode uden at ændre parameteren
		Talredigering	<ul style="list-style-type: none"> Flytter cursoren til plus/minustegnet, hvis dette er den første nedtrykkede tast eller flytter cursoren én plads mod venstre
	Slet	Talredigering	<ul style="list-style-type: none"> Sletter displayet
	Decimalpunktum	Talredigering	<ul style="list-style-type: none"> Indtaster et decimalpunktum
	Plus/minustegn	Talredigering	<ul style="list-style-type: none"> Skifter fortegnet på den indtastede værdi
	Tal	Talredigering	<ul style="list-style-type: none"> Indtaster det tilsvarende tegn.

Quick Start guide via den håndholdte programmeringsenhed

Bemærk: Hver gang Quick Start guiden startes, er udgangsindstillingerne fabriksindstillingerne. Guiden kan ikke huske tidligere brugerdefinerede indstillinger.

1. Quick Start

- Ret programmeringsenheden mod displayet (fra en afstand af max. 300 mm [1 ft]), og tryk på **HØJRE pil**  for at aktivere PROGRAM mode og åbne menuniveau 1.
- Tryk to gange på **HØJRE pil**  for at navigere hen til menupunkt 1.1 og åbne parameterskærmen.

- c) Tryk på **HØJRE pil** ➡ for at åbne **Redigeringsmode** eller **NED pil** ▼ for at acceptere standardværdierne og gå direkte til næste punkt.
- d) For at ændre en indstilling, rul hen til det ønskede punkt eller indtast en ny værdi.
- e) Efter at have ændret en værdi, tryk på **HØJRE pil** ➡ for at acceptere den og tryk på **NED pil** ▼ for at gå til næste punkt.
- f) Quick Start indstillingerne træder først i kraft, når der vælges **Yes (Ja)** til **Apply changes (Udfør ændringer)** i trin 1.7.

1.1. Materiale

Valgmuligheder	LIQUID (VÆSKE)
	LIQUID LOW DK (væske m. lav dielektricitetskonstant)

1.2. Svarhastighed

Indstiller apparatets reaktionshastighed over for ændringer i målingerne inden for målområdet.

Valgmuligheder	SLOW (LANGSOM)	0,1 m/minut
	MED (MIDDEL)	1,0 m/minut
	FAST (HURTIG)	10,0 m/minut

Brug en indstilling, der lige netop er hurtigere end den maksimale fyldnings- eller tømningshastighed (den største af disse).

1.3. Følerenheder

Vælger enhederne for Quick Start variablerne (højt og lavt kalibreringspunkt og niveau, afstand eller frirum).

Valgmuligheder	M, CM, MM, FT, IN
-----------------------	-------------------

1.4. Drift

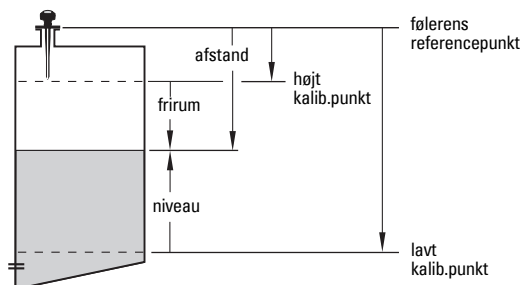

Driftstyper	NO SERVICE (IKKE I DRIFT)	SITRANS LR200 ophører med at opdatere målingerne og den tilhørende sløjfestrøm. Den sidste gyldige måling vises.
	LEVEL (NIVEAU)	Afstand til materialets overflade fra Lavt Kalibreringspunkt (proces tom-niveau).
	SPACE (FRIRUM)	Afstand til materialets overflade fra Højt Kalibreringspunkt (proces fuld-niveau).
	DISTANCE (AFSTAND)	Afstand til materialets overflade i forhold til Følerens referencepunkt.

1.5. Lavt Kalibreringspunkt

Afstand fra følerens reference til Lavt Kalibreringspunkt: normalt proces tom-niveau.

Værdier	Interval: fra 0,0000 til 20,000 m
----------------	-----------------------------------

1.6. Højt Kalibreringspunkt

Afstand fra følerens reference til Højt Kalibreringspunkt: normalt proces fuld-niveau.

Værdier	Interval: fra 0,0000 til 20,000 m
----------------	-----------------------------------

1.7. Apply? (Udfør ændringer)





For at gemme Quick Start indstillingerne er det nødvendigt at vælge **Yes (Ja)** for at udføre ændringerne.

Valgmuligheder	YES (JA), NO (NEJ)
-----------------------	--------------------

Displayet viser **DONE (Udført)**, når Quick Start er afsluttet med succes.

Tryk på **Mode**  for at vende tilbage til Målingsmode. SITRANS LR200 er nu klar til drift.

Forespørgsel om en Ekkoprofil

- 1) I PROGRAM mode, navigér hen til: **Level Meter (Niveaumåling)** > **Diagnostics (Diagnostik)** **(3)** > **Echo Profile (Ekkoprofil)** (3.1).
- 2) Tryk på **HØJRE pil**  for at bede om en profil.
- 3) I Profil-skærmen, tryk på **OP pilen**  for at vælge **Sende**-ikonet, og **HØJRE pil**  for at opdatere profilen.
- 4) Tryk på **NED pilen**  for at vælge **Exit**-ikonet, og derefter **HØJRE pil**  for at vende tilbage til den foregående menu.

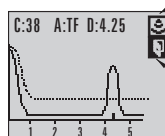
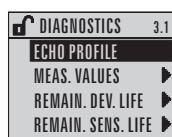

sende-ikon, ikke valgt

exit-ikon, valgt

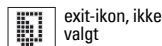

SITRANS LR200 Kommunikation: HART

- Det er nødvendigt at råde over den komplette manual for at have adgang til listen over mulige parametre.
- Vi anbefaler at bruge SIMATIC Process Device Manager (PDM) til at programmere apparatet.

SIMATIC PDM

Bemærkninger:

- Vi anbefaler brugen af SIMATIC PDM Rev. 6.0 SP3 eller højere.
- SIMATIC PDM Rev. 5.2 SP1 understøttes kun for grundlæggende konfiguration og problemløsning. For avancerede funktioner, såsom Quick Start guiden, kræves Revision 6.0 SP3 eller højere.

SIMATIC PDM er en softwarepakke, der bruges til at igangsætte og vedligeholde SITRANS LR200 og andre procesapparater. Læs venligst betjeningsvejledningen eller online-hjælpen for oplysninger om brugen af SIMATIC PDM. (Yderligere information kan findes på www.siemens.com/simatic-pdm). Gå til **Products and Solutions (Produkter og løsninger)** > **Products and Systems (Produkter og systemer)** > **Communications and Software (Kommunikation og software)** > **Process Device Manager (Procesapparatmanager)**.

Electronic Device Description (EDD - Elektronisk apparatbeskrivelse)

- EDD kan findes i Apparatkataloget (*Device Catalog*) under **Sensors/Level/Echo/Siemens Milltronics/SITRANS LR200**.
- Tjek produktsiden på vores website på: www.siemens.com/LR200 under **Downloads** for at sikre Dem, at De har den nyeste version af SIMATIC PDM, den seneste Service Pack (SP) og den seneste hot fix (HF). Hvis det er nødvendigt at installere en ny EDD, se *Konfiguration af et nyt apparat* herunder.

Konfiguration af et nyt apparat

Bemærk: Hvis der klikkes på **Cancel** (*Annullér*) i løbet af en uploading fra apparatet til SIMATIC PDM, vil nogle af parametrene blive opdateret.

1. Tjek, at De råder over den seneste EDD og download den om nødvendigt fra den ovenfor angivne produktside. Gem filerne på computeren og pak den zippede fil ud til en lettilgængelig placering. Start **SIMATIC PDM – Manager Device Catalog** (*SIMATIC PDM - Manager Apparatkatalog*), find den udpakkede EDD fil og vælg den.
2. Start SIMATIC PDM og opret et nyt projekt for LR200. Brugsanvisninger for opsætning af HART-apparater vha. SIMATIC PDM kan downloades på produktsiden på vores website på: www.siemens.com/LR200.
3. Upload parametrene til PC/PG.
4. Kalibrér apparatet vha. Quick Start guiden (se herunder).

Quick Start guide via SIMATIC PDM

Bemærkninger:

- Quick Start guidens indstillinger er indbyrdes forbundet og ændres først, når der klikkes på **Transfer** (*Overfør*) efter trin 5.
- Hver gang Quick Start guiden startes, er udgangsindstillingerne fabriksindstillingerne. Guiden kan ikke huske tidligere brugerdefinerede indstillinger.
- Klik på **BACK** (*Tilbage*) for at vende tilbage og ændre en indstilling eller **Cancel** (*Annullér*) for at forlade Quick Start.

Start SIMATIC PDM, åbn menuen **Device – Quick Start** (*Apparat - Quick Start*) og følg trin 1 til 5.

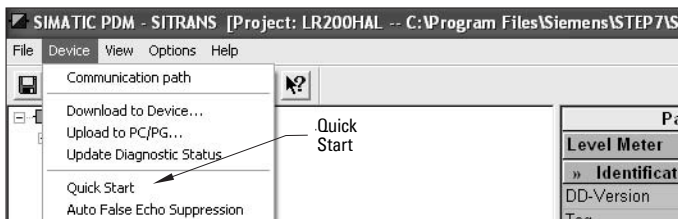

Vedligeholdelse

SITRANS LR200 kræver ingen vedligeholdelse eller rengøring under normale driftsbetingelser. Såfremt rengøring skulle blive nødvendig under hårde driftsbetingelser:

1. Kontrollér antennematerialet og procesmediet og vælg et rengøringsmiddel, der ikke reagerer u hensigtsmæssigt med det ene eller det andet.
2. Tag apparatet ud af drift og tør antennen ren ved hjælp af en klud og et egnet rengøringsmiddel.

Reparation af instrumentet og ansvarsbegrænsning

For yderligere oplysninger henvises der til indersiden af bagomslaget.

Diagram over maksimale procestemperaturer

! ADVARSEL: Den interne temperatur må ikke overskride 80 °C (176 °F).

Maksimale flange- og procestemperaturer som funktion af den tilladelige omgivelsestemperatur for versioner af SITRANS LR200 med flange-adapter

- Diagrammet er kun til orientering.
- Det dækker ikke ethvert muligt processtilslutningsarrangement. Det vil for eksempel IKKE gælde, hvis SITRANS LR200 monteres direkte på overfladen af en metallisk beholder.
- Det tager ikke højde for varme fra direkte sollys.
- Parameter 3.14.1 kan bruges til at overvåge den aktuelle interne temperatur.

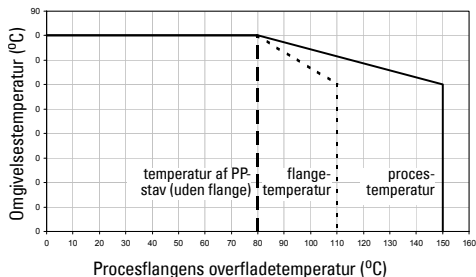

Sløjfeeffekt

Typisk forbindelsesdiagram

Bemærk: Sløjfespændingen er spændingen ved strømforsynings poler (ikke spændingen ved apparatets poler).

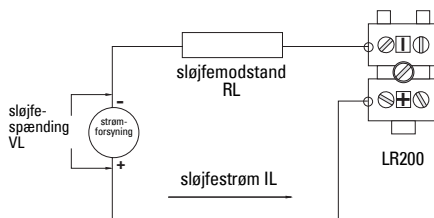

Tilladeligt driftsområde

Kurve 1 (Almen brug, Egensikker, Ikke-antændingsfarlig)

Sløjfespændingen som funktion af sløjfemodstanden

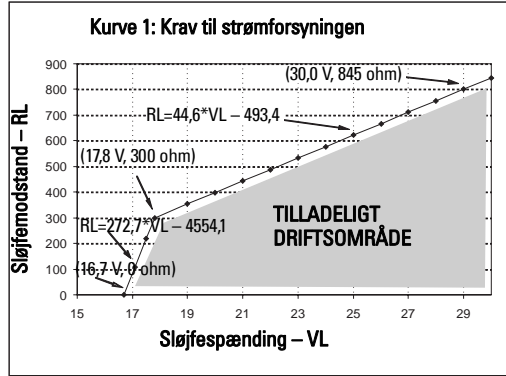

Kurve 2 (Flammesikker, Forhøjet sikkerhed, Eksplosionssikker)

Sløjfespændingen som funktion af sløjfemodstanden

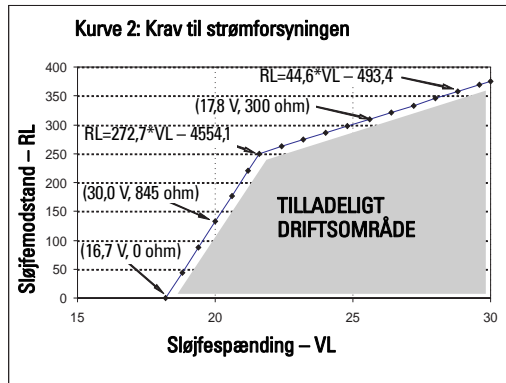

Opstartskurve

Bemærk: Ved opstart kan det tage mellem 25 og 55 sekunder, før apparatet viser det aktuelle materialniveau.

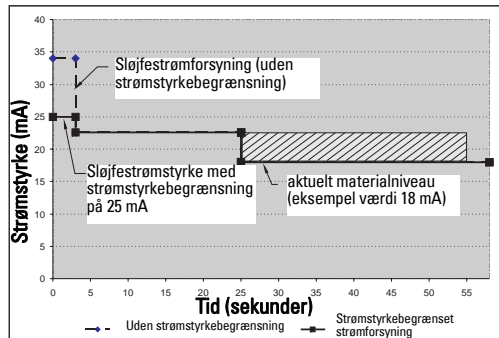

Dansk

Bemærkninger

Dansk

SITRANS LR200 (HART) mit Siemens LUI (lokale Benutzerschnittstelle): Kurzanleitung

Diese Betriebsanleitung ist eine Kurzfassung der wesentlichen Merkmale und Funktionen des SITRANS LR200 (HART). Es ist sehr empfehlenswert, die ausführliche Version der Anleitung zu erwerben, damit Sie Ihr Gerät optimal nutzen können. Die vollständige Betriebsanleitung kann von der SITRANS LR200 Produktseite auf unserer Website heruntergeladen werden: www.siemens.com/LR200. Ein gebundenes Exemplar können Sie von Ihrer örtlichen Siemens Milltronics Vertretung erhalten.

Wenn Sie Fragen haben, wenden Sie sich bitte an:

Siemens Milltronics Process Instruments Inc.
1954 Technology Drive, P.O. Box 4225
Peterborough, Ontario, Kanada, K9J 7B1
E-Mail: techpubs.smpi@siemens.com

**Copyright Siemens Milltronics
Process Instruments Inc. 2008.
All Rights Reserved**

Haftungsausschluss

Wir fordern Benutzer auf, genehmigte, gebundene Betriebsanleitungen zu erwerben oder die von Siemens Milltronics Process Instruments Inc. entworfenen und genehmigten elektronischen Ausführungen zu lesen. Siemens Milltronics Process Instruments Inc. ist für den Inhalt auszugsweiser oder vollständiger Wiedergaben gebundener oder elektronischer Ausführungen nicht verantwortlich.

Wir haben den Inhalt der Druckschrift auf Übereinstimmung mit dem beschriebenen Gerät geprüft. Dennoch können Abweichungen nicht ausgeschlossen werden, so dass wir für die vollständige Übereinstimmung keine Gewähr übernehmen. Die Angaben in dieser Druckschrift werden regelmäßig überprüft, und notwendige Korrekturen sind in den nachfolgenden Auflagen enthalten. Für Verbesserungsvorschläge sind wir dankbar. Technische Änderungen vorbehalten.

MILLTRONICS ist ein eingetragenes Warenzeichen der Siemens Milltronics Process Instruments Inc.

Technischer Support

Ein Support steht rund um die Uhr zur Verfügung.

Um die Adresse, Telefon- und Faxnummer Ihrer örtlichen Siemens Automation Geschäftsstelle zu finden, siehe:

www.siemens.com/automation/partner:

- Wählen Sie Deutsch als Sprache und klicken Sie auf **Partner für Produkte**; wählen Sie nun Ihre Produktgruppe (**+Prozessautomatisierung > +Prozessinstrumentierung > +Füllstandmessgeräte**).
- Wählen Sie den Bereich **Technischer Support**. Klicken Sie auf **Weiter**.
- Klicken Sie auf einen Kontinent, dann auf ein Land und eine Stadt. Klicken Sie auf **Weiter**.

Für technischen Support online, siehe: www.siemens.com/automation/support-request

- Wählen Sie Deutsch als Sprache und geben Sie den Produktnamen (SITRANS LR200) oder die Bestellnummer ein. Klicken Sie auf **Suchen** und treffen Sie die entsprechende Produktauswahl. Klicken Sie auf **Weiter**.
- Geben Sie ein Stichwort zur Beschreibung Ihres Problems ein. Suchen Sie entweder in den zugehörigen Dokumenten oder klicken Sie auf **Weiter**, um eine Beschreibung Ihres Problems an das Siemens Technical Support Team zu senden.

Siemens A&D Technical Support Center:

Tel. +49 180 50 50 222
Fax +49 180 50 50 223

Sicherheitstechnische Hinweise

Warnhinweise müssen zu Ihrer persönlichen Sicherheit sowie der Sicherheit Dritter und zur Vermeidung von Sachschäden beachtet werden. Zu jedem Warnhinweis wird der jeweilige Gefährungsgrad angegeben.



WARNUNG: bezieht sich auf ein Warnsymbol auf dem Produkt und bedeutet, dass bei Nicht-Einhalt der entsprechenden Vorsichtsmaßnahmen Tod, schwere Körperverletzung und/oder erheblicher Sachschaden eintreten können.



WARNUNG¹⁾: bedeutet, dass bei Nicht-Einhalt der entsprechenden Vorsichtsmaßnahmen Tod, schwere Körperverletzung und/oder erheblicher Sachschaden eintreten können.

Hinweis: steht für eine wichtige Information über das Produkt selbst oder den Teil der Betriebsanleitung, auf den besonders aufmerksam gemacht werden soll.

FCC Konformität

Nur für Installationen in den USA: Richtlinien der FCC (Federal Communications Commission)



WARNUNG: Änderungen oder Modifizierungen, die nicht ausdrücklich von Siemens Milltronics genehmigt wurden, können zum Entzug der Betriebsgenehmigung des Benutzers führen.

Hinweise:

- Dieses Gerät wurde getestet und mit den für ein Digitalgerät der Class A geltenden Grenzwerten, gemäß Teil 15 der FCC-Bestimmungen, für konform erklärt. Diese Grenzwerte sollen einen angemessenen Schutz vor Störungen gewährleisten, wenn das Gerät in einem Handlungsumfeld betrieben wird.
- Das Gerät erzeugt und verwendet Funkfrequenzen und kann sie ausstrahlen. Wenn es nicht gemäß der Betriebsanleitung installiert und betrieben wird, können Funkstörungen auftreten. Der Betrieb des Gerätes in einem Wohnbereich kann Störungen verursachen. In diesem Fall ist der Benutzer angehalten, die Störung auf eigene Kosten zu beheben.

SITRANS LR200



WARNUNG: Betriebssicherheit und Schutz des SITRANS LR200 sind nur gewährleistet, wenn das Gerät entsprechend dieser Betriebsanleitung betrieben wird.

Hinweis: Dieses Produkt ist vorgesehen zum Gebrauch in Industrieumgebungen. Bei Verwendung in Wohngebieten kann es zu Störungen von verschiedenen Funkanwendungen kommen.

SITRANS LR200 ist ein Zweileiter, 6 GHz Pulsradar-Füllstandmessumformer für Messbereiche bis 20 m (66ft). Er eignet sich für die kontinuierliche Überwachung von Flüssigkeiten und Schlämmen in Lager- und Prozessbehältern, auch bei hohen Temperaturen und Druck.

Das Gerät besteht aus einem Elektronikschaltkreis, der mit einer Antenne und entweder einem Gewinde- oder Flansch-Prozessanschluss verbunden ist.

¹⁾ Dieses Symbol wird verwendet, wenn sich kein entsprechendes Vorsichtssymbol auf dem Produkt befindet.

Die Kommunikation erfolgt über HART¹⁾. Zur Signalverarbeitung wird die Process Intelligence Software verwendet.

Technische Daten

Eine vollständige Liste finden Sie in der SITRANS LR200 (HART) Betriebsanleitung. Typen- und Prozessschild des Geräts liefern genaue Angaben zu den Zulassungen.

Umgebungs-/Betriebstemperatur

Hinweise:

- Prozesstemperatur und Druckwerte sind von den Angaben auf dem Prozessschild des Geräts abhängig. Die auf dem Schild angeführte Referenzzeichnung kann von der Siemens Webseite heruntergeladen werden: www.siemens.com/LR200.
- Die maximale Temperatur hängt von Prozessanschluss, Antennenwerkstoff und Behälterdruck ab. Nähere Angaben finden Sie unter *Kurve der maximalen Prozesstemperatur* auf Seite 22. Prozess Druck-/Temperaturkurven sind in der vollständigen Betriebsanleitung verfügbar.

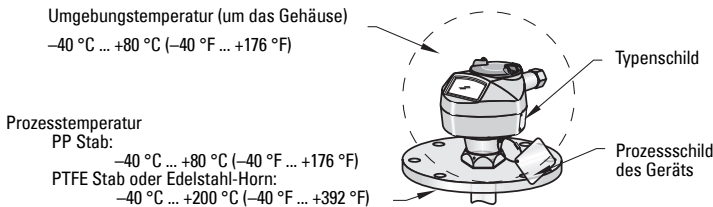

Hilfsenergie



Allgemeine Verwendung:
Betriebsmittel für Zone 2 (Non-incendive) (nur FM/US):
Eigensicher:

Nominal DC 24 V bei
max. 550 Ohm Schleifen-
widerstand.



Druckfest:
Erhöhte Sicherheit:
Druckfeste Kapselung (Explosion proof) (nur FM/CSA
US/Kanada):

Nominal DC 24 V bei
max. 250 Ohm Schleifen-
widerstand.

Zulassungen

- Allgemein CSA_{US/C}, FM, CE
- Funk Europa (R&TTE), FCC, Industry Canada

(Fortsetzung auf nächster Seite)

¹⁾ HART[®] ist ein eingetragenes Warenzeichen der HART Communications Foundation.

- Ex-Bereiche Druckfest (Europa)¹⁾ ATEX II 1/2 G, EEx dm ia IIC T4
- Erhöhte Sicherheit (Europa)²⁾ ATEX II 1/2 G, EEx em ia IIC T4
- Druckfeste Kapselung (US/Kanada)³⁾ FM/CSA: (Barriere nicht erforderlich)
Class I, Div. 1, Gruppen A, B, C, D
Class II, Div. 1, Gruppen E, F, G
Class III T4

Hinweis: Verwenden Sie geeignete Conduit- und Kabelverschraubungen, um die Schutzart IP oder NEMA zu gewährleisten.

Zulassungen (Fortsetzung)

- Ex-Bereiche Betriebsmittel für Zone 2 (Non-incendive) (US)⁴⁾ FM: (Barriere nicht erforderlich)
Class I, Div. 2, Gruppen A, B, C, D T5
- Eigensicher⁵⁾ (Europa) ATEX II 1 G, EEx ia IIC T4
- (US/Kanada) FM/CSA: (Barriere erforderlich)
Class I, Div. 1, Gruppen A, B, C, D
Class II, Div. 1, Gruppen E, F, G
Class III T4
- (Australien) ANZEX Ex ia IIC T4
(Tamb = -40 ... +80 °C) IP67
- (International) IECEX TSA 04.0020X T4
- Schiffsbauzulassung Lloyd's Register of Shipping
ABS Schiffbau-Zulassung

Programmiergerät (Infrarot-Tastatur)

Siemens Milltronics Infrarot Handprogrammiergerät (eigensicher) für explosionsgefährdete und alle anderen Bereiche (Batterie nicht austauschbar, voraussichtliche Lebensdauer von 10 Jahren bei normalem Gebrauch).

- Zulassung ATEX II 1 G, EEx ia IIC T4, Bescheinigung SIRA 01ATEX2147
FM/CSA: Class I, Div. 1, Gruppen A, B, C, D
- Umgebungstemperatur -20 ... 40 °C (-5 ... 104 °F)
- Schnittstelle patentiertes Infrarot-Impulssignal
- Hilfsenergie 3 V Lithium Batterie
- Gewicht 150 g (0.3 lb)
- Farbe schwarz
- Artikelnummer 7ML1930-1BK

¹⁾ Siehe *Anschlussmethode druckfest* auf Seite 9.

²⁾ Siehe *Anschlussmethode erhöhte Sicherheit* auf Seite 10.

³⁾ Siehe *Anschlussmethode druckfeste Kapselung (Explosion proof) (nur FM/CSA US/Kanada)* auf Seite 10.

⁴⁾ Siehe *Anschlussmethode Betriebsmittel für Zone 2 (Non-incendive) (nur FM/US):* auf Seite 11.

⁵⁾ Siehe *Anschlussmethode Eigensicher* auf Seite 11.

Applikationen mit Druck



- **WARNUNGEN:**
- **Dieses Produkt wird als druckhaltendes Ausrüstungsteil im Sinne der Richtlinie 97 / 23 / EG bezeichnet und ist nicht für den Einsatz als Sicherheitsvorrichtung bestimmt.**
- **Versuchen Sie niemals die Prozessdichtung oder das Gehäuse zu lockern, zu entfernen oder auseinanderzubauen, während der Inhalt des Behälters unter Druck steht.**
- **Eine unsachgemäße Installation kann zu Druckverlust im Prozess führen.**

Installation



- **WARNUNGEN:**
- **Die Installation darf nur durch qualifiziertes Personal und unter Beachtung der örtlichen, gesetzlichen Bestimmungen durchgeführt werden.**
- **Die Werkstoffe werden entsprechend ihrer chemischen Beständigkeit (oder Trägheit) für allgemeine Zwecke gewählt. Bei Einsatz in besonderen Umgebungen prüfen Sie vor Installation die chemische Beständigkeit anhand einschlägiger Tabellen.**

Hinweise:

- Das Prozessschild muss mit der Druckbaugruppe¹⁾ verbunden bleiben. Falls das Gerätegehäuse ausgetauscht werden soll, muss das Prozessschild auf das Austauschgerät übertragen werden.
- Jedes SITRANS LR200 Gerät ist hydrostatisch getestet. Es erfüllt oder übertrifft die Anforderungen des „ASME Boiler and Pressure Vessel Code“ und der Europäischen Druckgeräterichtlinie.

Installationsrichtlinien

- Sorgen Sie für einen einfachen Zugang zum Ablesen der Anzeige und zur Programmierung über das Handprogrammiergerät.
- Sorgen Sie für Umgebungsbedingungen, die mit den Nennwerten des Gehäuses und dem Werkstoff kompatibel sind.
- Verwenden Sie ein Sonnenschutzdach, wenn das Gerät direkter Sonneneinstrahlung ausgesetzt ist.

¹⁾ Die Druckbaugruppe besteht aus allen Bauteilen, die vor einem Druckverlust aus dem Prozessbehälter schützen, d. h. das Prozessanschlussgehäuse kombiniert mit dem Sender, normalerweise ohne das Elektronikgehäuse.

Design des Montagestutzens

Hinweise:

- Verwenden Sie den 100 mm (4") Schirm auf Stützen bis zu 100 mm (4") Länge.
- Verwenden Sie den 250 mm (10") Schirm auf Stützen bis zu 250 mm (10") Länge.
- Nähere Angaben zu anderen Anwendungen finden Sie in der Betriebsanleitung.

- Das Ende des abgeschirmten Teils muss mindestens 10 mm (0.4") in den Tank hineinragen, um Störechos, die vom Stutzen reflektiert werden, zu vermeiden.

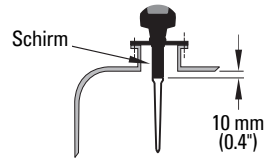

Einbauort auf einem Mannloch

- Ein solches Mannloch besitzt im Allgemeinen einen Montagestutzen mit einem Mindestdurchmesser von 610 mm (24") und einen Deckel.
- Für optimale Signalbedingungen ist die Antenne versetzt zu montieren. Im Allgemeinen gilt ein Abstand von 100 mm (4") von der Schachtseite.

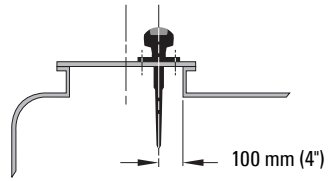

Anbringung des Montagestutzens

! WARNUNG: Bei Behältern mit konischer oder parabolförmiger Decke wird von einer mittigen Montage des Geräts abgeraten. (Durch die Wölbung der Decke kann es zu einer Konzentration der Echos auf die Mitte und dadurch zu falschen Messwerten kommen.)

Hinweis: Unter gewissen Umständen ist die mittige Montage des Geräts auf Behältern mit flacher Decke möglich. Bitte wenden Sie sich dazu an Ihre Siemens Vertretung.



✓✓ optimal ⚡ nicht empfohlen

- Der Radarkegel muss ohne Störung durch Leitern, Rohre, Doppel-T-Träger oder Befüllströme die Oberfläche des Messstoffs erreichen können.
- Bauen Sie die Antenne mit Abstand zur Tankwand ein und vermeiden Sie Störungen durch indirekte Echos.
- Achten Sie auf eine Zugabe für die Ausbreitung des Radarkegels, um eine Störung durch Behälterwände oder Einbauten zu vermeiden.

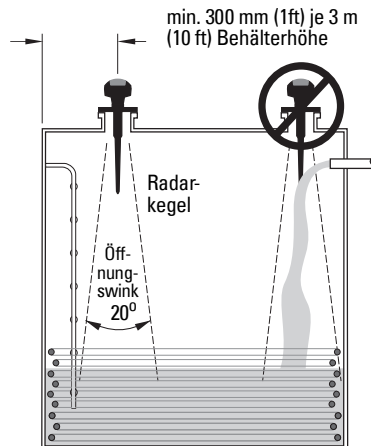

Einbauhinweise

Hinweise:

- Das Gerät kann beliebig oft gedreht werden.
- Richten Sie die Vorder- oder Rückseite des Gerätes zur nächsten Wand hin aus.
- Nach Programmierung und Gerätekonfiguration darf das Gehäuse nicht mehr gedreht werden (eine Polaritätsverlagerung des Sendepulses könnte einen Fehler verursachen).

Gewindeausführung

- 1) Vor Einbau des Gerätes ist es wichtig, die Übereinstimmung der Gewinde zu überprüfen, um eine Beschädigung zu vermeiden.
- 2) Schrauben Sie das Gerät in den Prozessanschluss und ziehen Sie es von Hand an. Für Druckbehälter verwenden Sie PTFE Band (oder anderen, geeigneten Dichtungsstoff); der Prozessanschluss ist stärker als von Hand anzuziehen (max. Drehkraft 40 N·m [30 ft.lbs]).
- 3) Um das Gehäuse zu drehen, lockern Sie zuerst die drei Gewindestifte, die den Sicherungsring befestigen. Nach der Positionierung des Gehäuses ziehen Sie die Stifte wieder an.

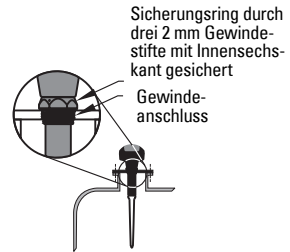

Flanschausführung



WARNUNG: Der Benutzer ist für die Auswahl von Schraub- und Dichtungsmaterial verantwortlich. Dieses muss den für den Flansch aufgestellten Bedingungen und dessen bestimmter Verwendung entsprechen und für die Betriebsbedingungen geeignet sein.

Anschluss Hilfsenergie

WARNUNGEN:



Um die Sicherheitsanforderungen der IEC 61010-1 zu erfüllen, sind die Gleichstrom-Eingangsklemmen von einer Quelle zu versorgen, die eine galvanische Trennung zwischen Ein- und Ausgang bewirkt.



Alle Feldanschlüsse müssen entsprechend der angelegten Spannung isoliert sein.

Anschluss des SITRANS LR200



! WARNUNGEN:

- Überprüfen Sie die Zulassungen auf dem Typen- und Prozessschild Ihres Gerätes.
- Verwenden Sie geeignete Conduit- und Kabelverschraubungen, um die Schutzart IP oder NEMA zu gewährleisten.
- Lesen Sie *Vorschriften bezüglich Installationen in Ex-Bereichen* auf Seite 13.

Hinweise:

- Für ausführliche Anweisungen zum Anschluss schlagen Sie bitte in der Betriebsanleitung nach.
- Verwenden Sie Kabel mit verdrehtem Aderpaar: Leitungsquerschnitt 0,34 mm² ... 2,5 mm² (AWG 22 ... 14).
- Eine getrennte Leitungsverlegung kann erforderlich sein, um Standardanforderungen an den Anschluss oder elektrische Richtlinien zu erfüllen.

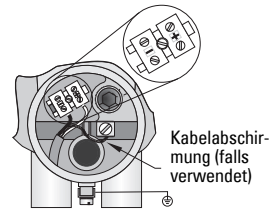
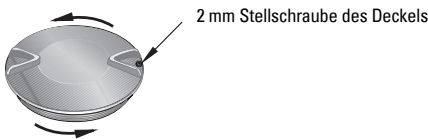

- 1) Die Stellschraube des Deckels mit einem 2 mm Inbusschlüssel lockern und dann den Deckel
- 2) Isolieren Sie den Kabelmantel ca. 70 mm (2,75") vom Ende des Kabels ab und führen Sie die Adern durch die Kabelverschraubung ein.
- 3) Anschluss der Drähte wie abgebildet: Die Polarität ist auf den Klemmen gekennzeichnet.
- 4) Nehmen Sie die Erdung des Geräts entsprechend lokaler Richtlinien vor.
- 5) Ziehen Sie die Verschraubung an, so dass sie gut abdichtet.
- 6) Den Deckel schließen und den Sicherungsring absichern, bevor die Programmierung und Gerätekonfiguration durchgeführt wird. Das Gerät nach der Konfiguration nicht mehr drehen; dies könnte Fehler verursachen.

Anschluss HART: typische SPS/mA Konfiguration

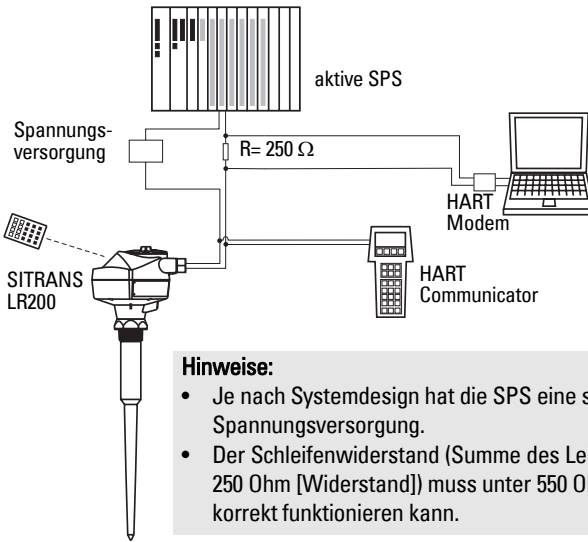

Hinweise:

- Je nach Systemdesign hat die SPS eine separate oder integrierte Spannungsversorgung.
- Der Schleifenwiderstand (Summe des Leitungswiderstands plus 250 Ohm [Widerstand]) muss unter 550 Ohm liegen, damit das Gerät korrekt funktionieren kann.

Anschlussmethoden bei Einbau in Ex-Bereichen

Hinweis: Die unten aufgeführten ATEX Zertifikate und Anschlusszeichnungen stehen auf der Produktseite im Internet zum Download zur Verfügung: www.siemens.com/LR200.

Für Installationen in explosionsgefährdeten Bereichen stehen fünf Anschlussoptionen zur Auswahl. Überprüfen Sie in allen Fällen die Zulassungen auf dem Typen- und Prozessschild Ihres Gerätes.

1. Anschlussmethode druckfest

SIEMENS			
SITRANS LR200 7ML1234-56789-0ABC-D Serial No: GYZ/S1034567 Endl.: NEMA/TYPX 4X, 6, IP67, IP68 Amb. Temp.: -40°C to 80°C Power Rating: 24V --- Nom., 30V --- Max., 4-20mA Siemens Milltronics Process Instruments Inc., Peterborough Made in Canada			
		 II 1/2 G EEx dmia IIC T4 SIRA 05ATEX1001X CE 0682 0518	HART Um=250V

Zulassung	Gültig für:	Referenz
ATEX II 1/2 G, EEx dm ia IIC T4	Europa	<i>Flameproof/Increased Safety: ATEX Certificate</i> auf Seite A-1.

- Angaben zum Strombedarf finden Sie unter *Kurve 2 (Druckfest, Erhöhte Sicherheit, Explosionssicher)* auf Seite 24.
- Für Anschlussanforderungen beachten Sie lokale Richtlinien.
- Siehe auch *Vorschriften bezüglich Installationen in Ex-Bereichen* auf Seite 13 und das oben aufgeführte ATEX Zertifikat.



2. Anschlussmethode erhöhte Sicherheit

SIEMENS					II 1/2 G	HART
SITRANS LR200 7ML1234-56789-0ABC-D Serial No.: GYZ/S1034567 Encl.: NEMA/TYP E 4X, 6, IP67, IP68 Amb. Temp.: -40 °C to 80 °C Power Rating: 24V $\frac{1}{2}$ Nom., 30V Max., 4-20mA Siemens Millitronics Process Instruments Inc., Peterborough Made in Canada					EEEx emia IIC T4	<input type="checkbox"/>
					05ATEX1001X	Um=250V
					0682	
					0518	

Zulassung	Gültig für:	Referenz
ATEX II 1/2 G, EEx em ia IIC T4	Europa	<i>Flameproof/Increased Safety: ATEX Certificate</i> auf Seite A-1.

- Angaben zum Strombedarf finden Sie unter *Kurve 2 (Druckfest, Erhöhte Sicherheit, Explosionssicher)* auf Seite 24.
- Für Anschlussanforderungen beachten Sie lokale Richtlinien.
- Siehe auch *Vorschriften bezüglich Installationen in Ex-Bereichen* auf Seite 13 und das oben aufgeführte ATEX Zertifikat.



3. Anschlussmethode druckfeste Kapselung (Explosion proof) (nur FM/CSA US/Kanada)

SIEMENS					Class I; Div 1; Group A, B, C, D	FCC ID: NJA-LR 200
SITRANS LR200 7ML1234-56789-0ABC-D Serial No.: GYZ/S1034567 Encl.: NEMA/TYP E 4X, 6, IP67, IP68 Amb. Temp.: -40 °C to 80 °C Power Rating: 24V $\frac{1}{2}$ Nom., 30V Max., 4-20mA Siemens Millitronics Process Instruments Inc., Peterborough Made in Canada					Class II; Div 1; Group E, F, G	CANADA: 267P-LR200
					Class III	HART
					Temp. Code: T4	<input type="checkbox"/>
					Per drawing: 23650597	
					159134	
					WARNING: Do Not Remove Cover While Circuits Are Live	

Zulassung	Gültig für:	Referenz
FM/CSA: Class I, Div. 1, Gruppen A, B, C, D Class II, Div. 1, Gruppen E, F, G Class IIIT4	US/Kanada	FM/CSA Druckfeste Kapselung Anschlusszeichnung-Nr. 23650597

- Angaben zum Strombedarf finden Sie unter *Kurve 2 (Druckfest, Erhöhte Sicherheit, Explosionssicher)* auf Seite 24.
- Angaben zu Anschlussanforderungen (nur Nordamerika) finden Sie in der oben aufgeführten Anschlusszeichnung, die auf der Produktseite unserer Webseite zum Download zur Verfügung steht: www.siemens.com/LR200.

4. Anschlussmethode Betriebsmittel für Zone 2 (Non-incendive) (nur FM/US):



SIEMENS	CANADA: 267P- FCC ID: NJA-LR200		Class I, Div. 2, Group A, B, C, D Temp. Code: T5
7ML1234-56789-0ABC-D Serial No: GYZ / S1034567 Encl.: NEMA / TYPE 4X, 6, IP67 Amb. Temp.: -40 °C to 80 °C Power Rating: 24V --- Nom., 30V --- Max., 4-20mA Siemens Millitronics Process Instruments Inc., Peterborough Made in Canada			
		This device complies with Part 15 of the FCC Rules. Operation is subject to the following two conditions 1) This device may not cause harmful interference and 2) This device must accept any interference received, including interference that may cause undesired operation	

Zulassung	Gültig für:	Referenz
FM: Class I, Div. 2, Gruppen A, B, C, D T5	USA	FM Betriebsmittel für Zone 2 (Non-Incendive) Anschlusszeichnung-Nr. 23650537

- Für Angaben zum Strombedarf siehe *Kurve 1 (Allg. Verwendung, Eigensicher, Non-incendive)* auf Seite 24.
- Angaben zu Anschlussanforderungen (nur Nordamerika) finden Sie in der oben aufgeführten Anschlusszeichnung, die auf der Produktseite unserer Webseite zum Download zur Verfügung steht: www.siemens.com/LR200.

5. Anschlussmethode Eigensicher

SIEMENS	
SITRANS LR200 7ML1234-56789-0ABC-D Serial No: GYZ / S1034567 Encl.: NEMA / TYPE 4X, 6, IP67, IP68 Amb. Temp.: -40 °C to 80 °C Power Rating: 24V --- Nom., 30V --- Max., 4-20mA Siemens Millitronics Process Instruments Inc., Peterborough Made in Canada	

Class I, Div 1, Group A, B, C, D Class II, Div 1, Group E, F, G Class III Temp. Code: T4 HART	Vmax = 30 V Imax = 120 mA Pmax = 0.8 W Ci = 15 nF Li = 0.1 mH CSA per drawing A5E01003039 IC: 267P-LR200 FM per drawing A5E01003040 FCC ID: NJA-LR200 WARNING: Possible Static Hazard, Do Not Rub Or Clean On Site	 159154 
---	---	--

SIEMENS	
SITRANS LR200 7ML1234-56789-0ABC-D Serial No: GYZ / S1034567 Encl.: NEMA / TYPE 4X, 6, IP67, IP68 Amb. Temp.: -40 °C to 80 °C Power Rating: 24V --- Nom., 30V --- Max., 4-20mA Siemens Millitronics Process Instruments Inc., Peterborough Made in Canada	

II 1 G EEx ia IIC T4 SIRA 06ATEX2378X CE 0682 QS 0518 HART 5.8 GHz	Ui = 30 V Ii = 120 mA Pi = 0.8 W Ci = 15 nF Li = 0.1 mH N117	IECEx TSA 04.0020X ANZEx 04.3016X Ex ia IIC T4 
---	---	---

Zulassung	Gültig für:	Referenz
FM/CSA: Class I, Div. 1, Gruppen A, B, C, D Class II, Div. 1, Gruppen E, F, G Class III	US/Kanada	FM Eigensicher Anschlusszeichnung-Nr. A5E01003040 CSA Eigensicher Anschlusszeichnung-Nr. A5E01003039
ATEX II 1 G, EEx ia IIC T4	Europa	<i>Intrinsically Safe: ATEX Certificate</i> auf Seite A-5
ANZEX Ex ia IIC T4 (Tamb = -40 ... 80 °C) IP67	Australien	
IECEX TSA 04.0020X	International	

- Angaben zum Strombedarf finden Sie unter *Kurve 1 (Allg. Verwendung, Eigensicher, Non-incendive)* auf Seite 24.

- Anschlussanforderungen:
 Nordamerika: Siehe oben aufgeführte Anschlusszeichnungen, die auf der Produktseite im Internet zum Download zur Verfügung stehen: www.siemens.com/LR200.
 Europa: Beachten Sie lokale Vorschriften.
 Australien: Beachten Sie lokale Vorschriften.
 International: Beachten Sie lokale Vorschriften.
- Verwenden Sie geeignete Conduit- und Kabelverschraubungen, um die Schutzart IP oder NEMA zu gewährleisten.
- Verwenden Sie ausschließlich eigensichere Zenerbarrieren gemäß der Liste unter *Passive Barrieren mit Shunt-Dioden* auf Seite 12.
- Siehe *Vorschriften bezüglich Installationen in Ex-Bereichen* auf Seite 13 und das oben aufgeführte ATEX Zertifikat.

Hinweis: Die Auswahl eines geeigneten SPS Eingangsmoduls (Spannungsversorgung) oder einer Barriere setzt Kenntnisse über die Eigensicherheit und die Applikation voraus. Die Verantwortung für die Übereinstimmung der eigensicheren Installation mit den Zulassungsanforderungen des Betriebsmittels und den relevanten, nationalen Verfahrensregeln liegt beim Installateur.

Passive Barrieren mit Shunt-Dioden

Hinweis: Eine gut geregelte Versorgungsspannung ist erforderlich.

Hersteller	Artikelnummer
MTL	787SP+ (zweikanalig)
MTL	7787P+ (zweikanalig)
Stahl	9001/01-280-100-10 (einkanalig)
Stahl	9002/01-280-110-10 (zweikanalig)

Auswahl einer passiven Barriere für SITRANS LR200

Um sicherzustellen, dass die Sicherheitsbeschreibung der Barriere für die Eingangsparameter Eigensicherheit (IS) des LR200 geeignet ist, führen Sie folgende Rechnung durch:

- Re-e = max. durchgehender Widerstand der Barriere
- R Schleife = Schleifenwiderstand (Summe des Leitungswiderstands plus z. B. Abtastwiderstand, Anzeigen und/oder SPS Eingänge)
- V Barriere = Wert aller unlinearen Spannungsabfälle aufgrund der Barriere

- 1) Bestimmen Sie den Wert für Re-e anhand des Datenblattes.
- 2) Berechnen Sie den Gesamtwert für R Schleife: z. B. durch Zugabe von Abtastwiderstand, Anzeigen und/oder SPS Eingängen.
- 3) Berechnen Sie R Betrieb = Re-e + R Schleife.

- 4) Bestimmen Sie den Wert für V Barriere anhand des Datenblattes (z. B. Spannungsabfälle durch Dioden).
- 5) Berechnen Sie $V_{\text{Betrieb}} = V_{\text{Versorgung}} - V_{\text{Barriere}}$.

Unter Verwendung der Werte von V_{Betrieb} und R_{Betrieb} ist zu bestätigen, dass der Betrieb innerhalb des schattierten Bereichs der *Kurve 1 (Allg. Verwendung, Eigensicher, Non-incendive)* auf Seite 24 liegt.

Hinweise:

- Folgende Liste ist unvollständig; es stehen zahlreiche IS Netzteile und Sicherheitsbarrieren für das LR200 zur Verfügung.
- Die unten aufgeführten SPS Eingangsmodule und Barrieren wurden alle getestet und sind funktionsgemäß mit dem LR200 kompatibel.

Aktive Barrieren

Hersteller	Artikelnummer
MTL	706
MTL	7206
Stahl	9001/51-280-110-14
Pepperl+Fuchs	KSD2-CI-S-Ex
Pepperl+Fuchs	KFD2-STC3-Ex1
MTL	E02009 - prüfen
MTL	E02010

**Vorschriften bezüglich Installationen in Ex-Bereichen
(Europäische ATEX Richtlinie 94/9/EG, Anhang II, 1/0/6)**

Folgende Vorschriften finden Anwendung auf die Geräte, die Gegenstand des Zertifikats Nr. SIRA 06ATEX2378X, SIRA 05ATEX1001X sind:

- 1) Angaben zu Verwendung und Zusammenbau finden Sie im Hauptteil der Vorschriften.
- 2) Das Gerät ist für den Einsatz als Betriebsmittel der Kategorie 1G zertifiziert.
- 3) Das Gerät kann mit brennbaren Gasen und Dämpfen mit Betriebsmitteln der Gruppen IIA, IIB und IIC und Temperaturklasse T1, T2, T3 und T4 eingesetzt werden.
- 4) Das Gerät ist für einen Einsatz bei Umgebungstemperaturen von -40 °C bis $+80\text{ °C}$ zugelassen.
- 5) Das Gerät wird nicht als Sicherheitseinrichtung (im Sinne der Richtlinie 94/9/EG Anhang II, Klausel 1,5) eingestuft.
- 6) Installation und Prüfung dieses Geräts dürfen nur durch entsprechend geschultes Personal in Übereinstimmung mit den geltenden Verfahrensregeln (EN 60079-14 und EN 60079-17 in Europa) durchgeführt werden.

Deutsch

- 7) Das Gerät ist nicht reparierbar.
- 8) Die Zertifizierungsnummer besitzt eine Endung 'X' zur Angabe, dass für die sichere Verwendung Sonderbedingungen gelten. Personen, die diese Betriebsmittel installieren oder warten, müssen Zugriff auf die Bescheinigung haben.
- 9) Es sind geeignete Maßnahmen zu treffen, um eine Beschädigung des Geräts im Falle eines Kontakts mit aggressiven Stoffen zu verhindern und die Schutzart zu gewährleisten.

Aggressive Stoffe: z. B. säurehaltige Flüssigkeiten oder Gase, die Metalle angreifen können, oder Lösungen, die polymerische Stoffe angreifen.

Geeignete Maßnahmen: z. B. Aufstellung der Beständigkeit gegen bestimmte Chemikalien anhand des Datenblatts des Materials.

Einschalten des SITRANS LR200

Gerät einschalten. SITRANS LR200 startet automatisch im Messmodus. (Um die angezeigte Sprache einzustellen, siehe: *Eine aufgelistete Option wählen (z. B. Auswahl einer Sprache)* auf Seite 17.)

Die Anzeige (LCD)

Messmodus (Normalbetrieb)

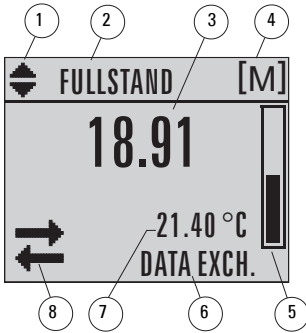

- 1 – Symbol Umschalten für lineare Einheiten oder %
- 2 – gewählte Betriebsart: Füllstand, Leerraum oder Abstand
- 3 – Messwert (Füllstand oder Volumen, Leerraum oder Abstand)
- 4 – Einheiten
- 5 – Balkenskala zur Füllstandanzeige
- 6 – Im Zusatz-Anzeigefeld erscheint auf Anfrage¹⁾ die Elektroniktemperatur, Echogüte, der Schleifenstrom oder Abstand
- 7 – Textbereich zur Anzeige von Statusmeldungen
- 8 – Symbol Gerätezustand

Anliegen eines Fehlers



S: 0 LOE

- 7 – Textbereich zur Anzeige eines Fehlercodes oder einer Fehlermeldung
- 8 – Anzeige des Symbols Service erforderlich

PROGRAMMIER-Modus

Navigationsansicht

- Eine sichtbare Menüleiste zeigt an, dass die Menüliste zu lang ist, um alle Einträge anzuzeigen.
- Je höher der Eintragsbalken, desto kürzer die Menüliste.

aktuelles Menü

Eintragsbalken

Menüleiste

aktuelle Eintragsnummer

aktueller Eintrag

Zeiger

¹⁾ Als Antwort auf eine Anfrage per Tastendruck; siehe *Tastenfunktion im Messmodus* auf Seite 15.

Parameteransicht

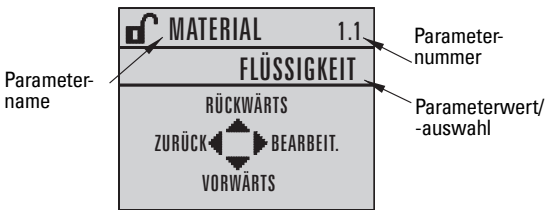

Bearbeitungsansicht



Handprogrammiergerät

(Artikelnr. 7ML1930-1BK)



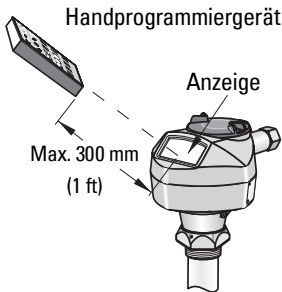

Das Programmiergerät ist separat zu bestellen.

- Richten Sie das Programmiergerät auf die Anzeige (aus maximal 300 mm [1 ft] Abstand).
- Drücken Sie Taste Modus zum Umschalten zwischen Mess- und PROGRAMMIER-Modus.



Tastenfunktion im Messmodus

Taste	Funktion	Ergebnis
	Modus öffnet den PROGRAMMIER-Modus.	Öffnet die zuletzt angezeigte Menü-Ebene, seitdem das Gerät zuletzt eingeschaltet wurde, oder Menü-Ebene 1, wenn das Gerät seit Verlassen des PROGRAMMIER-Modus ausgeschaltet wurde oder mehr als 10 Minuten vergangen sind, seit der PROGRAMMIER-Modus zuletzt aktiviert wurde.
	RECHTS-Pfeil öffnet den PROGRAMMIER-Modus.	Öffnet Menü-Ebene 1.
 	Pfeil nach OBEN oder UNTEN schaltet zwischen linearen Einheiten und Prozent um.	Der Messwert wird entweder in linearen Einheiten oder Prozent angezeigt.

Taste	Funktion	Ergebnis
	Aktualisiert den Schleifenstrom.	Anzeige des neuen Wertes im Zusatzfeld des LCD.
	Aktualisiert die Anzeige der Temperatur im Gehäuse.	
	Aktualisiert den Echogütwert.	
	Aktualisiert die Abstandsmessung.	

Programmierung des SITRANS LR200

Hinweis: SITRANS LR200 kehrt nach einer gewissen Ruhezeit im PROGRAMMIER-Modus (zwischen 15 Sekunden und 10 Minuten, je nach Menü-Ebene) automatisch in den Messmodus zurück.

Die Einstellungen können über die lokale Benutzeroberfläche oder entfernt über SIMATIC PDM geändert werden. Die lokale Benutzeroberfläche (LUI, local user interface) umfasst eine LCD Anzeige und ein Handprogrammiergerät.

- Siehe *Schnellstartassistent mit dem Handprogrammiergerät* auf Seite 18.
- Siehe *Schnellstartassistent über SIMATIC PDM* auf Seite 21.

Parametermenüs

Hinweis: Eine Liste aller Parameter mit Anweisungen finden Sie in der ausführlichen Betriebsanleitung. Diese steht auf der Produktseite unserer Webseite zum Download zur Verfügung: www.siemens.com/LR200.

Die Parameter sind durch Namen gekennzeichnet und in Funktionsgruppen gegliedert. Ihre Anordnung entspricht einer 5-stufigen Menüstruktur.







1. QUICK START
2. EINSTELLUNG
3. DIAGNOSE
 - 3.14. MESSWERTE
 - 3.14.1. AKT. INNENTEMP

Zugriff auf Parameter über Handprogrammiergerät

1. Aufruf PROGRAMMIER-Modus





- a) Richten Sie das Programmiergerät auf die Anzeige (aus maximal 300 mm [1 ft] Abstand).
- b) Drücken Sie den **RECHTS-Pfeil** , um Menü-Ebene 1 zu öffnen.

2. Navigation: Tastenfunktion im Navigationsmodus

Taste	Name	Menü-Ebene	Funktion
 	Pfeil nach OBEN oder UNTEN	Menü oder Parameter	<ul style="list-style-type: none"> Auf das vorige oder nächste Menü bzw. den vorigen oder nächsten Parameter blättern.
	RECHTS-Pfeil	Menü	<ul style="list-style-type: none"> Aufruf des ersten Parameters im gewählten Menü oder nächstes Menü öffnen.
		Parameter	<ul style="list-style-type: none"> Aufruf des Bearbeitungs-Modus.
	LINKS-Pfeil	Menü oder Parameter	<ul style="list-style-type: none"> Aufruf übergeordnetes Menü.
	Modus	Menü oder Parameter	<ul style="list-style-type: none"> Übergang auf MESS-Modus.
	Home	Menü oder Parameter	<ul style="list-style-type: none"> Öffnet Menü-Ebene 1.

3. Bearbeiten im PROGRAMMIER-Modus

Eine aufgelistete Option wählen (z. B. Auswahl einer Sprache)

- Aufruf von **Language (7)**.
- Drücken Sie den **RECHTS-Pfeil** , um die Parameteransicht zu öffnen.
- Drücken Sie erneut den **RECHTS-Pfeil** , um den Modus **Bearbeiten** zu starten. Die aktuelle Auswahl ist hervorgehoben.
- Blättern Sie auf eine neue Auswahl.
Drücken Sie den **RECHTS-Pfeil**  zur Bestätigung. Das LCD kehrt auf die Parameteransicht zurück und zeigt die neue Auswahl an.
- Der **LINKS-Pfeil**  erlaubt die Rückkehr aufs Menü.

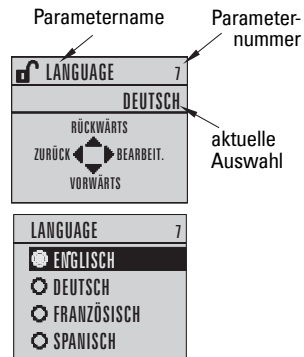

Einen numerischen Wert ändern

- Rufen Sie den gewünschten Parameter auf.
- Drücken Sie den **RECHTS-Pfeil** , um die Parameteransicht zu öffnen. Der aktuelle Wert wird angezeigt.

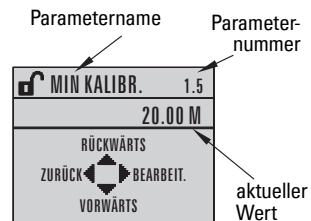

- c) Drücken Sie erneut den **RECHTS-Pfeil** , um den Modus **Bearbeiten** zu starten. Der aktuelle Wert wird hervorgehoben.











- d) Geben Sie einen neuen Wert ein und drücken Sie den

RECHTS-Pfeil  zur Bestätigung.

Das LCD kehrt auf die Parameteransicht zurück und zeigt die neue Auswahl an.



Tastenfunktionen im Modus Bearbeiten





Taste	Name	Funktion	
 	Pfeil nach OBEN oder UNTEN	Optionsauswahl	<ul style="list-style-type: none"> • Blättert auf den Eintrag.
		Numerische Bearbeitung	<ul style="list-style-type: none"> • Erhöht oder vermindert Zahlen • Schaltet das Vorzeichen um (plus/minus)
	RECHTS-Pfeil	Optionsauswahl	<ul style="list-style-type: none"> • Bestätigt Daten (schreibt den Parameter) • Modus wechselt von Bearbeiten auf Navigation
		Numerische Bearbeitung	<ul style="list-style-type: none"> • Bewegt den Cursor eine Stelle nach rechts • oder, wenn sich der Cursor auf dem Enter-Zeichen befindet: bestätigt Daten und setzt den Modus von Bearbeiten auf Navigation
	LINKS-Pfeil	Optionsauswahl	<ul style="list-style-type: none"> • Abbruch der Bearbeitung, ohne den Parameter geändert zu haben.
		Numerische Bearbeitung	<ul style="list-style-type: none"> • Bewegt den Cursor auf das Plus/Minus-Zeichen, wenn dies die erste Taste ist, die gedrückt wird • oder bewegt den Cursor eine Stelle nach links.
	Löschen	Numerische Bearbeitung	<ul style="list-style-type: none"> • Löscht die Anzeige.
	Dezimalstelle	Numerische Bearbeitung	<ul style="list-style-type: none"> • Eingabe eines Dezimalpunkts.
	Plus/Minus-Zeichen	Numerische Bearbeitung	<ul style="list-style-type: none"> • Ändert das Vorzeichen des eingegebenen Wertes.
 bis 	Ziffern	Numerische Bearbeitung	<ul style="list-style-type: none"> • Eingabe des entsprechenden Zeichens.

Schnellstartassistent mit dem Handprogrammiergerät

Hinweis: Bei jedem Aufruf des Schnellstartassistenten entsprechen die Anlauf-Einstellungen den Werkseinstellungen. Der Assistent ruft keine vorigen, benutzerdefinierten Einstellungen ab.

1. Schnellstart

- Richten Sie das Programmiergerät auf die Anzeige (aus maximal 300 mm [1 ft] Abstand); drücken Sie dann den **RECHTS-Pfeil**  zur Aktivierung der PROGRAMMIERUNG und öffnen Sie Menü-Ebene 1.
- Drücken Sie den **RECHTS-Pfeil**  zweimal, um Menüeintrag 1.1 aufzurufen und die Parameteransicht zu öffnen.

- c) Drücken Sie den **RECHTS-Pfeil** , um den Modus **Bearbeiten** zu öffnen, oder den **Pfeil nach UNTEN** , um die Vorgabewerte zu bestätigen und zum nächsten Eintrag zu gelangen.
- d) Zur Änderung einer Einstellung blättern Sie auf den gewünschten Eintrag oder geben Sie einen neuen Wert ein.
- e) Nachdem der Wert geändert wurde, drücken Sie den **RECHTS-Pfeil**  zur Bestätigung und den **Pfeil nach UNTEN** , um zum nächsten Eintrag zu gelangen.
- f) Schnellstarteinstellungen treten erst in Kraft, wenn **Ja** in **Änderungen durchführen** in Schritt 1.7 gewählt wurde.

1.1. Material

Optionen	FLÜSSIGKEIT
	FLÜSSIGK. NIED. (Flüssigkeit mit niedriger Dielektrizitätszahl)

1.2. Reaktionszeit

Einstellung der Geschwindigkeit, mit der das Gerät auf Änderungen im Zielbereich reagiert.

Optionen	LANGSAM	0,1 m/Minute
	MITTEL	1,0 m/Minute
	SCHNELL	10,0 m/Minute

Die Einstellung sollte die max. Geschwindigkeit beim Befüllen oder Entleeren (es gilt der größere Wert) gerade etwas übersteigen.

1.3. Sensoreinheiten

Auswahl der Einheiten für die Schnellstart-Variablen (Min und Max Kalibrierpunkt, Füllstand, Abstand oder Leerraum).

Optionen	M, CM, MM, FT, IN
-----------------	-------------------

1.4. Betrieb

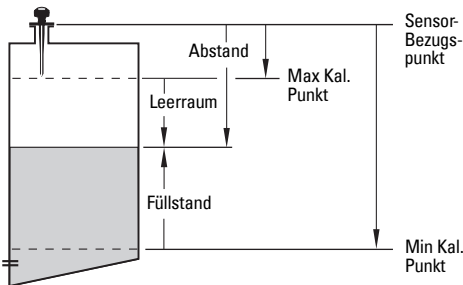

Betriebsarten	KEIN BETRIEB	Das SITRANS LR200 bricht die Aktualisierung der Messungen und des zugehörigen Schleifenstroms ab. Die zuletzt gültige Messung wird angezeigt.
	FÜLLSTAND	Abstand zur Materialoberfläche bezogen auf den Min Kalibrierpunkt (Nullpunkt des Prozesses).
	LEERRAUM	Abstand zur Materialoberfläche bezogen auf den Max Kalibrierpunkt (Vollpunkt des Prozesses).
	ABSTAND	Abstand zur Materialoberfläche bezogen auf den Sensor-Bezugspunkt.

1.5. Min Kalibrierpunkt

Abstand vom Sensor Bezugspunkt zum Min Kalibrierpunkt: entspricht in der Regel dem Nullpunkt des Prozesses.

Werte	Bereich: 0,0000 ... 20,000 m
--------------	------------------------------

1.6. Max Kalibrierpunkt

Abstand vom Sensor Bezugspunkt zum Max Kalibrierpunkt: entspricht in der Regel dem Vollpunkt des Prozesses.

Werte	Bereich: 0,0000 ... 20,000 m
--------------	------------------------------

1.7. Durchführen? (Änderungen durchführen)





Um die Schnellstart-Einstellungen zu speichern, wählen Sie **Ja** in Änderungen durchführen.

Optionen	JA, NEIN
-----------------	----------

Auf der Anzeige erscheint **ABGESCHL**, wenn der Schnellstart erfolgreich durchgeführt wurde.

Drücken Sie **Modus** , um in den Messmodus zurückzukehren. SITRANS LR200 ist nun betriebsbereit.

Anforderung eines Echoprofils

- 1) Im PROGRAMMIER-Modus, Aufruf von: **Füllstandmessgerät > Diagnose (3) > Echoprofil (3.1)**
- 2) Drücken Sie den **RECHTS-Pfeil** , um ein Profil anzufordern.
- 3) Im Profil-Bildschirm drücken Sie den **Pfeil nach OBEN**  zur Auswahl des Symbols **Übertragen** und den **RECHTS-Pfeil**  zur Aktualisierung des Profils.
- 4) Drücken Sie den **Pfeil nach UNTEN**  zur Auswahl des Symbols **Verlassen**, gefolgt vom **RECHTS-Pfeil**  zur Rückkehr auf das vorige Menü.

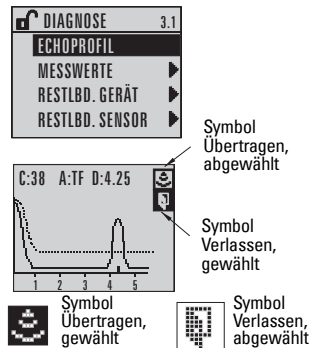

SITRANS LR200 Kommunikation: HART

- Eine Liste aller zutreffenden Parameter finden Sie in der ausführlichen Betriebsanleitung.
- Zur Programmierung Ihres Geräts empfehlen wir SIMATIC Process Device Manager (PDM).

SIMATIC PDM

Hinweise:

- Wir empfehlen die Verwendung von SIMATIC PDM ab Rev. 6.0 SP3.
- SIMATIC PDM Rev. 5.2 SP1 wird nur für eine grundlegende Konfiguration und Fehlersuche unterstützt. Erweiterte Funktionen, wie der Schnellstartassistent, erfordern die Revision 6.0 SP3 oder höher.

SIMATIC PDM ist ein Softwarepaket für die Inbetriebnahme und Wartung des SITRANS LR200 und anderer Prozessgeräte. Bitte ziehen Sie die Betriebsanweisungen oder Online Hilfe zur Verwendung von SIMATIC PDM zu Rate. (Nähere Informationen dazu finden Sie unter www.siemens.com/simatic-pdm. Gehen Sie zu **Products and Solutions > Products and Systems > Communications and Software > Process Device Manager**.)

Electronic Device Description (EDD)

- Sie finden die EDD im Gerätekatalog, unter **Sensors/Level/Echo/Siemens Milltronics/SITRANS LR200**.
- Gehen Sie zur Produktseite im Internet: www.siemens.com/LR200, unter **Downloads**, um sicherzustellen, dass Sie die neueste Version von SIMATIC PDM, das aktuellste Servicepaket (SP) und den aktuellsten Hotfix (HF) haben. Wenn Sie eine neue EDD installieren müssen, siehe *Konfiguration eines neuen Gerätes* unten.

Konfiguration eines neuen Gerätes

Hinweis: Das Anklicken von **Abbrechen** während eines Uploads vom Gerät auf SIMATIC PDM hat zur Folge, dass einige Parameter aktualisiert werden.

1. Überprüfen Sie, ob Sie die neueste EDD besitzen und laden Sie sie bei Bedarf von der oben aufgelisteten Produktseite herunter. Speichern Sie die Dateien auf Ihrem Computer und extrahieren Sie die komprimierte Datei in eine leicht erreichbare Stelle. Starten Sie **SIMATIC PDM – Manager Device Catalog**, blättern Sie bis zur entzippten EDD Datei und wählen Sie diese.
2. Starten Sie SIMATIC PDM und legen Sie ein neues Projekt für LR200 an. Anwendungsanleitungen zur Einstellung von HART Geräten mit SIMATIC PDM können von der Produktseite unserer Website unter folgender Adresse heruntergeladen werden: www.siemens.com/LR200.
3. Laden der Parameter in PC/PG.
4. Konfigurieren Sie das Gerät mit dem Schnellstartassistenten (siehe unten).

Schnellstartassistent über SIMATIC PDM

Hinweise:

- Die Einstellungen des Schnellstartassistenten sind zusammenhängend und Änderungen werden erst wirksam, wenn Sie am Ende von Schritt 5 auf **Übertragen** klicken.
- Bei jedem Aufruf des Schnellstartassistenten entsprechen die Anlauf-Einstellungen den Werkseinstellungen. Der Assistent ruft keine vorigen, benutzerdefinierten Einstellungen ab.
- Klicken Sie auf **RÜCKWÄRTS**, um zurückzukehren und die Einstellung zu überprüfen oder auf **Abbrechen**, um den Schnellstart zu verlassen.

Starten Sie SIMATIC PDM, öffnen Sie das Menü **Gerät – Quick Start** und folgen Sie den Schritten 1 bis 5.

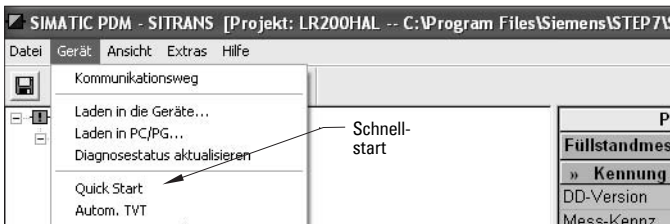

Wartung

Unter normalen Betriebsbedingungen erfordert SITRANS LR200 keine Wartung oder Reinigung. Bei sehr harten Betriebsbedingungen wird eine Reinigung jedoch erforderlich:

1. Berücksichtigen Sie das Antennenmaterial und das Prozessmedium und wählen Sie dementsprechend ein angemessenes Reinigungsmittel.
2. Bauen Sie das Gerät aus und wischen Sie die Antenne mit einem Tuch und einer geeigneten Reinigungslösung ab.

Gerätereparatur und Haftungsausschluss

Nähere Angaben finden Sie auf der hinteren Umschlaginnenseite.

Kurve der maximalen Prozesstemperatur

! WARNUNG: Die Innentemperatur darf 80 °C (176 °F) nicht überschreiten!

Max. Flansch-/Prozesstemperatur im Vgl. zur zulässigen Umgebungstemperatur für die Flanschadapter-Ausführung des SITRANS LR200

- Die Kurve dient nur der Veranschaulichung.
- Es werden nicht alle möglichen Prozessanschlüsse dargestellt. Es trifft beispielsweise NICHT zu, wenn das SITRANS LR200 direkt an einer Behälteroberfläche aus Metall montiert ist.
- Eine Erwärmung durch direkte Sonneneinstrahlung wird im Schaubild nicht berücksichtigt.
- Mit Parameter 3.14.1 kann die aktuelle Innentemperatur überwacht werden.

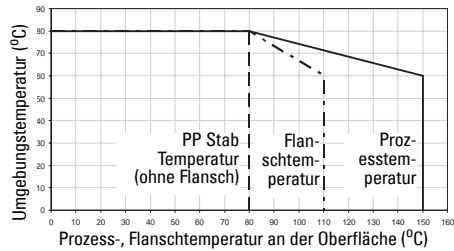

Schleifenstrom

Typische Anschlusszeichnung

Hinweis: Die Schleifenspannung entspricht der Spannung an den Klemmen der Spannungsversorgung (nicht der Spannung an den Klemmen des Geräts).

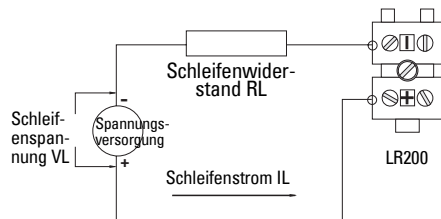

Zulässiger Betriebsbereich

Kurve 1 (Allg. Verwendung, Eigensicher, Non-incendive)

Schleifenspannung zu Schleifenwiderstand

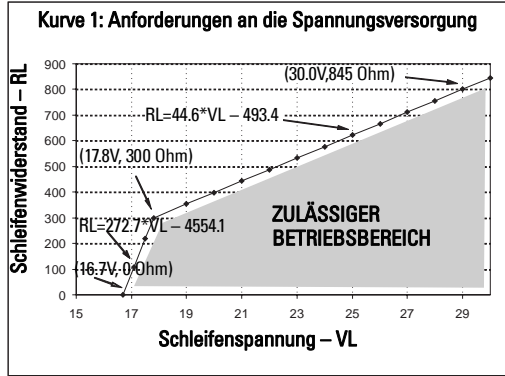

Kurve 2 (Druckfest, Erhöhte Sicherheit, Explosionssicher)

Schleifenspannung zu Schleifenwiderstand

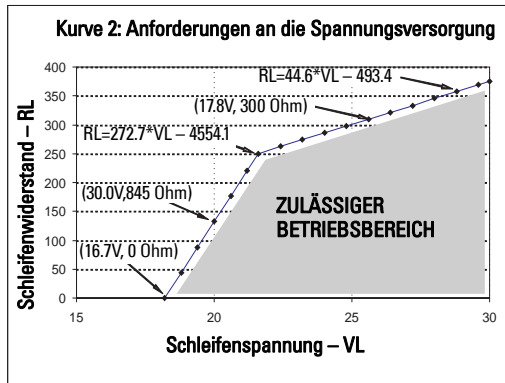

Anlaufkurve

Hinweis: Bei der Inbetriebnahme dauert es ca. 25 bis 55 Sekunden, bis das Gerät den Ist-Materialfüllstand anzeigt.

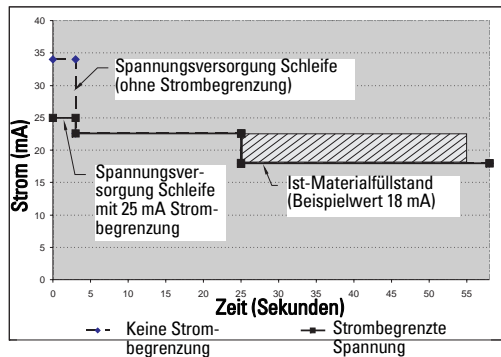

Deutsch

Notizen

SITRANS LR200 (HART) με διεπαφή LUI της Siemens: Περιληπτικό Εγχειρίδιο Οδηγιών

Το παρόν εγχειρίδιο περιγράφει τα βασικά χαρακτηριστικά και λειτουργίες του SITRANS LR200 (HART). Σας συνιστούμε να αποκτήσετε την πλήρη έκδοση του εγχειριδίου, ώστε να μπορείτε να αξιοποιήσετε όλες τις δυνατότητες της συσκευής σας. Μπορείτε να «κατεβάσετε» το πλήρες εγχειρίδιο από τη σελίδα προϊόντος του SITRANS LR200 της τοποθεσίας μας web στο Διαδίκτυο: www.siemens.com/LR200. Το εγχειρίδιο σε έντυπη μορφή διατίθεται από τον τοπικό αντιπρόσωπο της Siemens Milltronics.

Ερωτήσεις σχετικά με τα περιεχόμενα του εγχειριδίου αυτού μπορείτε να απευθύνετε προς τη:

Siemens Milltronics Process Instruments Inc.
1954 Technology Drive, P.O. Box 4225
Peterborough, Ontario, Canada, K9J 7B1
Email: techpubs.smpi@siemens.com

Πνευματικά δικαιώματα: Siemens Milltronics Process Instruments Inc. 2008. Δήλωση αποποίησης Με την επιφύλαξη παντός δικαιώματος

Παροτρύνουμε τους χρήστες να αγοράζουν εξουσιοδοτημένα έντυπα εγχειρίδια ή να ανατρέχουν σε ηλεκτρονικές εκδόσεις των εγχειριδίων που έχουν δημιουργηθεί και εγκριθεί από τη Siemens Milltronics Process Instruments Inc. Η Siemens Milltronics Process Instruments Inc. δεν φέρει ευθύνη για τα περιεχόμενα των αντιγράφων ολόκληρου ή μέρους του αναπαράχθεντος εγχειριδίου, ανεξάρτητα από το αν πρόκειται για ηλεκτρονική έκδοση ή εκτυπωμένο αντίγραφο.

Παρόλο που έχουμε ελέγξει ότι τα περιεχόμενα του παρόντος εγχειριδίου συμφωνούν με τα όργανα που περιγράφονται, τυχόν διαφοροποιήσεις είναι πιθανές. Επομένως, δεν μπορούν να εγγυηθούμε πλήρη συμφωνία μεταξύ των περιεχομένων του και της συσκευής που αγοράσατε. Τα περιεχόμενα του εγχειριδίου αυτού επανεξετάζονται σε τακτά χρονικά διαστήματα και οι διορθώσεις ενσωματώνονται στις νέες εκδόσεις του. Κάθε πρόταση για τυχόν βελτιώσεις είναι ευπρόσδεκτη.

Τα τεχνικά χαρακτηριστικά υπόκεινται σε τροποποιήσεις.

Το MILLTRONICS είναι σήμα κατατεθέν της Siemens Milltronics Process Instruments Inc.

Τεχνική Υποστήριξη

Υποστήριξη παρέχεται σε 24ωρη βάση.

Για να βρείτε τη διεύθυνση, τον αριθμό τηλεφώνου και τον αριθμό φαξ του τοπικού αντιπροσώπου της Siemens, επισκεφθείτε τη διεύθυνση:

www.siemens.com/automation/partner:

- Κάντε κλικ στην καρτέλα **Contacts by Product** (Στοιχεία επικοινωνίας με βάση το προϊόν) και μετά βρείτε τη σελίδα του προϊόντος σας (**+Process Automation (Αυτοματισμός διεργασίας)**) > **+Process Instrumentation (Όργανα διεργασίας)** > **+Level Measuring Instruments (Όργανα μέτρησης στάθμης)**.
- Επιλέξτε την ομάδα **Technical Support (Τεχνική Υποστήριξη)**. Κάντε κλικ στο **Next (Επόμενο)**.
- Κάντε κλικ σε μια ήπειρο, μετά σε μια χώρα και τέλος σε μια πόλη. Κάντε κλικ στο **Next**.

Για on-line τεχνική υποστήριξη επισκεφθείτε τη διεύθυνση:

www.siemens.com/automation/support-request

- Εισαγάγετε το όνομα της συσκευής (SITRANS LR200) ή τον αριθμό παραγγελίας, μετά κάντε κλικ στο **Search (Αναζήτηση)** και επιλέξτε τον κατάλληλο τύπο προϊόντος. Κάντε κλικ στο **Next**.
- Πληκτρολογήστε μια λέξη κλειδί που περιγράφει το θέμα σας. Στη συνέχεια, αναζητήστε την κατάλληλη τεκμηρίωση ή κάντε κλικ στο **Next** για να στείλετε με ηλεκτρονικό μήνυμα την περιγραφή του θέματός σας στο προσωπικό της Τεχνικής Υποστήριξης της Siemens.

Κέντρο Τεχνικής Υποστήριξης Siemens A&D : τηλέφωνο +49 180 50 50 222
φαξ +49 180 50 50 223

Οδηγίες ασφαλείας

Οι προειδοποιητικές υποδείξεις πρέπει να τηρούνται προκειμένου να διασφαλίζεται η προσωπική σας ασφάλεια και η ασφάλεια τρίτων καθώς και να προστατεύεται το προϊόν και ο συνδεδεμένος με αυτό εξοπλισμός. Οι προειδοποιητικές υποδείξεις συνοδεύονται από μια επεξήγηση σχετικά με το βαθμό της προφύλαξης που πρέπει να λαμβάνεται.



ΠΡΟΕΙΔΟΠΟΙΗΣΗ: σχετίζεται με ένα προειδοποιητικό σύμβολο πάνω στο προϊόν και σημαίνει ότι η μη τήρηση των απαιτούμενων προφυλάξεων μπορεί να προκαλέσει θάνατο, σοβαρό τραυματισμό και/ή σημαντικές υλικές ζημιές.



ΠΡΟΕΙΔΟΠΟΙΗΣΗ¹⁾: σημαίνει ότι η μη τήρηση των απαιτούμενων προφυλάξεων μπορεί να προκαλέσει θάνατο, σοβαρό τραυματισμό και/ή σημαντικές υλικές ζημιές.

Σημείωση: επισημαίνει σημαντικές πληροφορίες σχετικά με το προϊόν ή με το συγκεκριμένο τμήμα του εγχειριδίου χρήσης.

Συμμόρφωση FCC

Μόνο εγκαταστάσεις Η.Π.Α.: Κανόνες της Ομοσπονδιακής Επιτροπής για τις Επικοινωνίες (FCC)



ΠΡΟΕΙΔΟΠΟΙΗΣΗ: Αλλαγές ή τροποποιήσεις χωρίς ρητή έγκριση από τη Siemens Milltronics θα μπορούσαν να ακυρώσουν την άδεια του χρήστη να χρησιμοποιεί τον εξοπλισμό.

Σημειώσεις:

- Ο παρών εξοπλισμός ελέγχθηκε και βρέθηκε ότι συμμορφώνεται με τα όρια ψηφιακής συσκευής Κλάσης Α, σύμφωνα με το Μέρος 15 των κανόνων της επιτροπής FCC. Τα όρια αυτά έχουν οριστεί για να παρέχουν λογική προστασία από επιβλαβείς παρεμβολές, όταν ο εξοπλισμός λειτουργεί σε επιχείρηση.
- Ο παρών εξοπλισμός παράγει, χρησιμοποιεί και μπορεί να εκπέμπει ενέργεια σε ραδιοσυχνότητες και, σε περίπτωση που δεν εγκατασταθεί και χρησιμοποιηθεί σύμφωνα με το εγχειρίδιο οδηγιών, ενδέχεται να προκαλέσει επιβλαβείς παρεμβολές στις ραδιοεπικοινωνίες. Είναι πιθανόν η λειτουργία του παρόντος εξοπλισμού σε κατοικημένη περιοχή να προκαλέσει επιβλαβείς παρεμβολές στις ραδιοεπικοινωνίες, περίπτωση κατά την οποία απαιτείται από το χρήστη να διορθώσει τις παρεμβολές με δικό του κόστος.

SITRANS LR200



ΠΡΟΕΙΔΟΠΟΙΗΣΗ: Το SITRANS LR200 πρέπει να χρησιμοποιείται μόνο με τον τρόπο που περιγράφεται στο παρόν εγχειρίδιο, διαφορετικά ενδέχεται να διακυβευτεί η ασφάλεια που παρέχει ο εξοπλισμός.

Σημείωση: Το προϊόν αυτό προορίζεται για χρήση σε βιομηχανικό περιβάλλον. Η λειτουργία του παρόντος εξοπλισμού σε κατοικημένη περιοχή ενδέχεται να προκαλέσει παρεμβολές σε ορισμένες ραδιοεπικοινωνίες.

Το SITRANS LR200 είναι ένας παλμικός πομπός ραντάρ μέτρησης στάθμης 2 καλωδίων στα 6 GHz για τη συνεχή παρακολούθηση υγρών και κοινών σε δοχεία αποθήκευσης και διεργασίας υπό υψηλή πίεση και θερμοκρασία, για απόσταση έως 20 m (66 πόδια).

Η συσκευή αποτελείται από ένα ηλεκτρονικό κύκλωμα που συνδέεται στην κεραία και σε ένα σπειροτομημένο συνδετήρα διεργασίας ή συνδετήρα διεργασίας με φλάντζα.

¹⁾ Αυτό το σύμβολο χρησιμοποιείται όταν δεν υπάρχει αντίστοιχο προειδοποιητικό σύμβολο στο προϊόν.

Η επικοινωνία γίνεται μέσω του πρωτοκόλλου HART¹⁾. Η επεξεργασία των σημάτων πραγματοποιείται με χρήση της τεχνολογίας Process Intelligence.

Προδιαγραφές

Για τον πλήρη κατάλογο προδιαγραφών, ανατρέξτε στο Εγχειρίδιο Οδηγιών του SITRANS LR200 (HART). Σε ό,τι αφορά τις πληροφορίες για τις εγκρίσεις, ανατρέξτε στην πινακίδα ονόματος της συσκευής και στην ετικέτα της συσκευής διεργασίας.

Θερμοκρασία περιβάλλοντος/λειτουργίας

Σημειώσεις:

- Τα όρια θερμοκρασίας και πίεσης της διεργασίας εξαρτώνται από τις πληροφορίες στην ετικέτα της συσκευής διεργασίας. Το διάγραμμα αναφοράς που αναφέρεται στην ετικέτα μπορείτε να το «κατεβάσετε» από την τοποθεσία web της Siemens: www.siemens.com/LR200.
- Η μέγιστη θερμοκρασία εξαρτάται από τη σύνδεση διεργασίας, τα υλικά κατασκευής της κεραίας και την πίεση του δοχείου. Βλέπε *Διάγραμμα μέγιστης τιμής θερμοκρασίας διεργασίας* όδες *αάββää 22* για περισσότερες λεπτομέρειες. Οι καμπύλες μείωσης ονομαστικών τιμών για αυξημένη θερμοκρασία-πίεση διεργασίας διατίθενται στο πλήρες εγχειρίδιο.

θερμοκρασία περιβάλλοντος (γύρω από το περιβλημα)
-40° C έως +80° C (-40° F έως +176° F)

θερμοκρασία διεργασίας
ραβδοειδής κεραία PP:
-40° C έως +80° C (-40° F έως +176° F)
ραβδοειδής κεραία PTFE ή χροανοειδής κεραία SS:
-40° C έως +200° C (-40° F έως +392° F)



πινακίδα ονόματος
συσκευής

ετικέτα συσκευής διεργασίας

Τροφοδοσία



Γενικής χρήσης:
Μη εμπρηστική (FM/Η.Π.Α. μόνο):
Ενδογενώς ασφαλής:

Ονομαστική τάση 24 V DC
με μέγ. αντίσταση
βρόχου 550 Ohm.



Πυρίμαχη:
Αυξημένης ασφάλειας:
Αντικεκρηκτική (FM/CSA, Η.Π.Α./Καναδάς μόνο):

Ονομαστική τάση 24 V DC
με μέγ. αντίσταση
βρόχου 250 Ohm.

Εγκρίσεις

- Γενική CSA_{US/C}, FM, CE
- Ραδιοσυχνότητα Ευρώπη (R&TTE), FCC, Industry Canada

(συνέχεια στην επόμενη σελίδα)

¹⁾ Το HART[®] είναι σήμα κατατεθέν του HART Communication Foundation.

- Επικινδυνότητας Πυρίμαχη (Ευρώπη)¹⁾ ATEX II 1/2 G, EEx dm ia IIC T4
 Αυξημένης ασφάλειας (Ευρώπη)²⁾ ATEX II 1/2 G, EEx em ia IIC T4
 Αντικερκτική (Η.Π.Α./Καναδάς)³⁾ FM/CSA: (δεν απαιτείται φράγμα)
 Κλάση I, Τμ. 1, Ομάδες A, B, C, D
 Κλάση II, Τμ. 1, Ομάδες E, F, G
 Κλάση III T4

Σημείωση: Χρησιμοποιήστε κατάλληλα στεγανοποιητικά αγωγών για τη διατήρηση της ταξινόμησης IP ή NEMA.

Εγκρίσεις (συνέχεια)

- Επικινδυνότητας
 Μη εμπρηστική (Η.Π.Α)⁴⁾ FM: (δεν απαιτείται φράγμα)
 Κλάση I, Τμ. 2, Ομάδες A, B, C, D T5
 Ενδογενώς ασφαλής⁵⁾
 (Ευρώπη) ATEX II 1 G, EEx ia IIC T4
 (Η.Π.Α./Καναδάς) FM/CSA: (απαιτείται φράγμα)
 Κλάση I, Τμ. 1, Ομάδες A, B, C, D
 Κλάση II, Τμ. 1, Ομάδες E, F, G
 Κλάση III T4
 (Αυστραλία) ANZEX Ex ia IIC T4
 (Θεπρ. = -40 έως +80° C) IP67
 (Διεθνής) IECEx TSA 04.0020X T4
- Ναυτική Νηογνώμων Lloyds
 Έγκριση τύπου ABS

Προγραμματιστής (πληκτρολόγιο υπερύθρων)

Φορητός προγραμματιστής υπερύθρων IS (Ενδογενώς Ασφαλής) της Siemens Milltronics για επικίνδυνους και όλους τους άλλους χώρους (η μπαταρία δεν αντικαθίσταται και έχει διάρκεια ζωής 10 χρόνια σε συνθήκες κανονικής χρήσης).

- έγκριση ATEX II 1 G, EEx ia IIC T4, πιστοποιητικό SIRA 01ATEX2147
 FM/CSA: Κλάση I, Τμ. 1, Ομάδες A, B, C, D
- θερμοκρασία περιβάλλοντος -20 έως 40° C (-5 έως 104° F)
- διεπαφή παλμικό σήμα υπερύθρων κατασκευαστή
- τροφοδοσία μπαταρία λιθίου 3 V
- βάρος 150 g (0,3 lb)
- χρώμα μαύρο
- κωδικός είδους 7ML1930-1BK

1) Βλέπε *Πυρίμαχη καλωδίωση* στη σελίδα 9.

2) Βλέπε *Καλωδίωση αυξημένης ασφάλειας* στη σελίδα 10.

3) Βλέπε *Αντικερκτική καλωδίωση (FM/CSA, Η.Π.Α./Καναδάς μόνο)* στη σελίδα 10.

4) Βλέπε *Μη εμπρηστική καλωδίωση (FM/Η.Π.Α. μόνο)* στη σελίδα 11.

5) Βλέπε *Ενδογενώς ασφαλής καλωδίωση:* στη σελίδα 11.

Συσκευή υπό πίεση



ΠΡΟΕΙΔΟΠΟΙΗΣΕΙΣ:

- Το παρόν προϊόν χαρακτηρίζεται ως Εξάρτημα Υπό Πίεση, όπως ορίζεται από την Οδηγία 97 / 23 / ΕΚ, και **δεν** προορίζεται για χρήση ως συσκευή ασφαλείας.
- Μην επιχειρήσετε να χαλαρώσετε, να αφαιρέσετε ή να αποσυναρμολογήσετε το συνδετήρα διεργασίας ή το περίβλημα του οργάνου, ενώ τα περιεχόμενα του δοχείου βρίσκονται υπό πίεση.
- Η μη ενδεδειγμένη εγκατάσταση μπορεί να έχει ως αποτέλεσμα την απώλεια της πίεσης διεργασίας.

Εγκατάσταση



ΠΡΟΕΙΔΟΠΟΙΗΣΕΙΣ:

- Η εγκατάσταση πρέπει να πραγματοποιείται από εξειδικευμένο προσωπικό και σύμφωνα με τους κατά τόπους ισχύοντες κανονισμούς.
- Τα υλικά κατασκευής έχουν επιλεγεί με βάση τη χημική τους συμβατότητα (ή αδράνεια) για γενική χρήση. Σε ό,τι αφορά την έκθεση σε συγκεκριμένο περιβάλλον, αντιπαραβάλετε με τους πίνακες χημικής συμβατότητας, πριν προχωρήσετε στην εγκατάσταση.

Σημειώσεις:

- Η Ετικέτα Συσκευής Διεργασίας πρέπει να παραμένει στο διαχωριστικό συγκρότημα πίεσης διεργασίας¹⁾. Σε περίπτωση που η συσκευασία της συσκευής αντικατασταθεί, η Ετικέτα Συσκευής Διεργασίας πρέπει να μεταφέρεται στη μονάδα αντικατάστασης.
- Οι μονάδες SITRANS LR200 έχουν υποβληθεί σε υδροστατικούς ελέγχους και ικανοποιούν ή υπερβαίνουν τις απαιτήσεις του Κώδικα ASME για λέβητες και δοχεία πίεσης καθώς και της Ευρωπαϊκής Οδηγίας περί εξοπλισμού υπό πίεση.

Οδηγίες εγκατάστασης

- Εξασφαλίστε εύκολη πρόσβαση για παρακολούθηση της οθόνης και προγραμματισμό μέσω του φορητού προγραμματιστή.
- Δημιουργήστε κατάλληλο περιβάλλον ανάλογα με τα ονομαστικά χαρακτηριστικά του περιβλήματος και τα υλικά κατασκευής.
- Χρησιμοποιήστε σκίαστρο, αν η συσκευή πρόκειται να είναι εκτεθειμένη στο φως του ήλιου.

¹⁾ Το διαχωριστικό συγκρότημα πίεσης διεργασίας περιλαμβάνει τα εξαρτήματα που ενεργούν ως φράγμα κατά της απώλειας πίεσης από το δοχείο διεργασίας: δηλ. το συνδυασμό του σώματος σύνδεσης διεργασίας και του πομπού, αλλά κανονικά χωρίς να περιλαμβάνει το ηλεκτρικό περίβλημα.

Σχεδιασμός ακροφυσίου

Σημειώσεις:

- Για ακροφύσια με μήκος 100 mm (4") ή μικρότερο μήκος, χρησιμοποιήστε τη θωράκιση 100 mm (4").
- Για ακροφύσια με μήκος 250 mm (10") ή μικρότερο μήκος, χρησιμοποιήστε τη θωράκιση 250 mm (10").
- Για λεπτομέρειες σχετικά με άλλες εφαρμογές, ανατρέξτε στο πλήρες εγχειρίδιο.

- Το άκρο του τμήματος της θωράκισης θα πρέπει να προεξέχει τουλάχιστον 10 mm (0.4"), ώστε να αποφεύγεται η ανάκλαση παρασιτικής ηχούς από το ακροφύσιο.

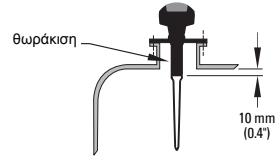

Θέση σε καπάκι φρεατίου επίσκεψης

- Ένα καπάκι φρεατίου επίσκεψης είναι συνήθως ένα καλυμμένο ακροφύσιο με διάμετρο 610 mm (24") ή μεγαλύτερη διάμετρο.
- Για βέλτιστες συνθήκες σήματος, τοποθετήστε την κεραία μη κεντρικά, συνήθως 100 mm (4") από την πλευρά.

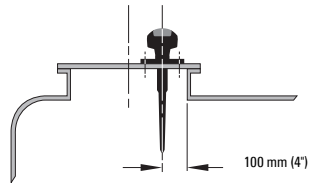

Θέση ακροφυσίου

- ! **ΠΡΟΕΙΔΟΠΟΙΗΣΗ:** Σε δοχεία με κωνικές ή παραβολικές κορυφές, αποφύγετε την τοποθέτηση του οργάνου στο κέντρο. (Η κοίλη επιφάνεια της κορυφής μπορεί να συγκεντρώσει ηχώ στο κέντρο, παρέχοντας εσφαλμένες ενδείξεις.)

Σημείωση: Σε ορισμένες περιπτώσεις, ενδέχεται να είναι αποδεκτή η τοποθέτηση της συσκευής στο κέντρο ενός δοχείου με επίπεδη κορυφή. Συζητήστε το θέμα αυτό με τον τοπικό αντιπρόσωπο της Siemens.

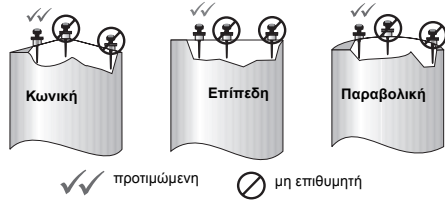

- Διατηρήστε τον κώνο εκπομπής απαλλαγμένο από παρεμβολές που μπορεί να προέρχονται από σκάλες, σωλήνες, δοκούς διατομής σχήματος I ή ροές πλήρωσης.
- Τοποθετήστε την κεραία μακριά από το πλευρικό τοίχωμα, ώστε να αποφευχθούν τυχόν παρεμβολές από έμμεση ηχώ.
- Λάβετε υπόψη το άνοιγμα του κώνου εκπομπής, για την αποφυγή παρεμβολών από τα τοιχώματα του δοχείου ή τυχόν εμπόδια.

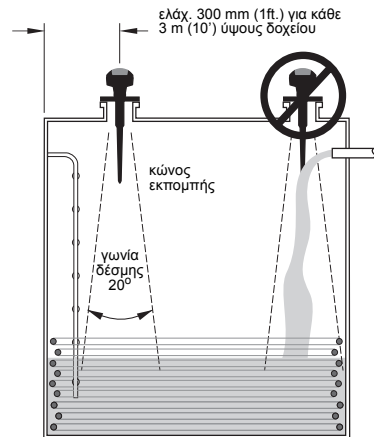

Οδηγίες εγκατάστασης

Σημειώσεις:

- Δεν υπάρχει όριο ως προς το πόσες φορές που μπορεί να περιστραφεί η συσκευή.
- Προσανατολίστε το μπροστινό ή το πίσω μέρος της συσκευής προς το κοντινότερο τοίχωμα του δοχείου.
- Μην περιστρέψετε το περίβλημα μετά τον προγραμματισμό και τη ρύθμιση των παραμέτρων της συσκευής (η αλλαγή της πολικότητας του παλμού εκπομπής μπορεί να προκαλέσει σφάλμα).

Σπειροτομημένη έκδοση

- 1) Πριν εισαγάγετε τη συσκευή στο συνδετήρα τοποθέτησης, βεβαιωθείτε ότι τα σπειρώματα ταιριάζουν, προκειμένου να αποφευχθεί ενδεχόμενη καταστροφή τους.
- 2) Βιδώστε τη συσκευή στο συνδετήρα διεργασίας και σφίξτε την με το χέρι. Σε συσκευές υπό πίεση, χρησιμοποιήστε ταινία PTFE ή άλλο κατάλληλο υλικό στεγανοποίησης σπειρωμάτων και σφίξτε περαιτέρω το συνδετήρα διεργασίας, αφού πρώτα τον σφίξετε με το χέρι σας (μέγ. ροπή 40 Nm (30 ft.lbs)).
- 3) Για να περιστρέψετε το περίβλημα, χαλαρώστε πρώτα τις τρεις ρυθμιζόμενες βίδες ασφάλισης του δακτυλίου ασφάλισης. Αφότου τοποθετήσετε το περίβλημα, ξανασφίξτε τις βίδες.



Έκδοση με φλάντζα



ΠΡΟΕΙΔΟΠΟΙΗΣΗ: Ο χρήστης είναι υπεύθυνος για την επιλογή των υλικών πάκτωσης και των παρεμβυσμάτων, ώστε να εμπίπτουν στα όρια της φλάντζας και της προβλεπόμενης χρήσης της, και τα οποία να είναι κατάλληλα για τις συνθήκες λειτουργίας.

Καλωδίωση

Τροφοδοσία

ΠΡΟΕΙΔΟΠΟΙΗΣΕΙΣ:



Οι ακροδέκτες εισόδου DC πρέπει να παρέχονται από πηγή που παρέχει ηλεκτρική μόνωση μεταξύ της εισόδου και της εξόδου, προκειμένου να ικανοποιούνται οι ισχύουσες απαιτήσεις ασφάλειας του IEC 61010-1.



Όλα τα καλώδια της εγκατάστασης πρέπει να είναι κατάλληλα μονωμένα, ανάλογα με την ονομαστική τάση.

Σύνδεση του SITRANS LR200



ΠΡΟΕΙΔΟΠΟΙΗΣΕΙΣ:

- Ελέγξτε την πινακίδα ονόματος της συσκευής και την ετικέτα συσκευής διεργασίας, για να βεβαιωθείτε για το είδος της έγκρισης.
- Χρησιμοποιήστε κατάλληλα στεγανοποιητικά αγωγών για τη διατήρηση της ταξινόμησης IP ή NEMA.
- Διαβάστε τις *Οδηγίες ειδικά για εγκαταστάσεις σε επικίνδυνες περιοχές* στη σελίδα 13.

Σημειώσεις:

- Για λεπτομερείς οδηγίες καλωδίωσης, ανατρέξτε στο πλήρες Εγχειρίδιο Οδηγιών.
- Χρησιμοποιήστε συνεστραμμένο ζεύγος καλωδίων: AWG 22 έως 14 (0,34 mm² έως 2,5 mm²).
- Μπορεί να χρειαστούν ξεχωριστά καλώδια και αγωγοί για συμμόρφωση με τις πρότυπες πρακτικές καλωδίωσης οργάνων ή τους ηλεκτρικούς κώδικες.

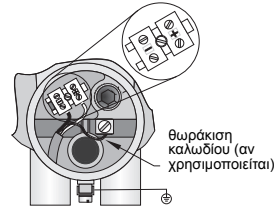

- 1) Χρησιμοποιήστε ένα κλειδί Allen 2 mm για να χαλαρώσετε τη βίδα ρύθμισης της ασφάλειας καπακιού και μετά ξεβιδώστε το καπάκι.
- 2) Απογυμνώστε το μανδύα του καλωδίου για 70 mm (2,75") περίπου από το άκρο του καλωδίου και περάστε με σπειροτόμηση τα καλώδια μέσα από το στυπιοθλίπτη.
- 3) Συνδέστε τα καλώδια στον ακροδέκτη, όπως φαίνεται στο σχήμα: η πολικότητα επισημαίνεται στο μπλοκ ακροδεκτών.
- 4) Γειώστε τη συσκευή σύμφωνα με τους τοπικούς κανονισμούς.
- 5) Σφίξτε το στυπιοθλίπτη για να πετύχετε καλή στεγάνωση.
- 6) Κλείστε το καπάκι και ασφαλίστε το δακτύλιο ασφάλισης, πριν ξεκινήσετε τον προγραμματισμό και τη ρύθμιση των παραμέτρων της συσκευής. Μην περιστρέψετε τη συσκευή αφού ρυθμίσετε τις παραμέτρους της, διότι μπορεί να προκληθεί σφάλμα.

Σύνδεση HART: τυπική διαμόρφωση PLC/mA

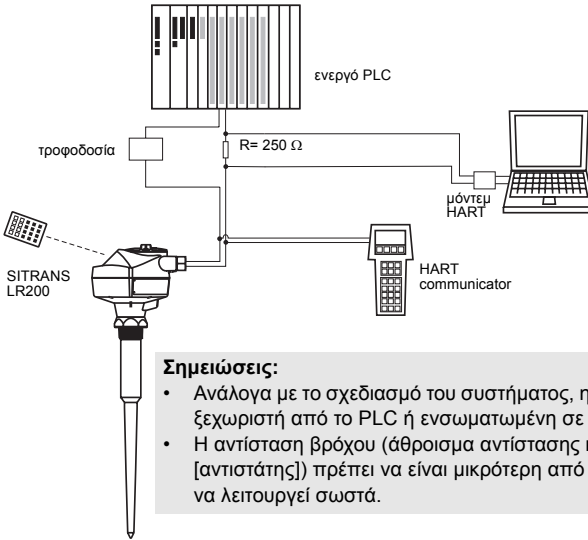

Καλωδιώσεις για εγκαταστάσεις σε επικίνδυνες περιοχές

Σημείωση: Τα πιστοποιητικά ATEX και τα διαγράμματα συνδέσεων που παρατίθενται πιο κάτω μπορούν να ληφθούν από τη σελίδα προϊόντων της τοποθεσίας μας web στο Διαδίκτυο: www.siemens.com/LR200.

Υπάρχουν πέντε επιλογές καλωδίωσης για εγκαταστάσεις σε επικίνδυνες περιοχές. Σε κάθε περίπτωση, ελέγξτε την πινακίδα ονόματος της συσκευής και την ετικέτα της συσκευής διεργασίας, για να βεβαιωθείτε για το είδος της έγκρισης.

1. Πυρίμαχη καλωδίωση



SIEMENS				
SITRANS LR200 7ML1234-56789-0ABC-D Serial No: GYZ/S1034567 Encl.: NEMA/TYPER 4X, 6, IP67, IP68 Amb. Temp.: -40°C to 80°C Power Rating: 24V $\overline{=}$ Norm., 30V $\overline{=}$ Max., 4-20mA Siemens Milltronics Process Instruments Inc., Peterborough Made in Canada			II 1/2 G EEx dmia IIC T4 SIRA 05ATEX1001X CE 0682 0518	HART Um = 250V

Είδος έγκρισης	Έγκυρο για:	Αναφορά
ATEX II 1/2 G, EEx dm ia IIC T4	Ευρώπη	Flameproof/Increased Safety: ATEX Certificate στη σελίδα A-1.

- Για τις απαιτήσεις ισχύος, βλέπε Καμπύλη 2 (Πυρίμαχη, Αυξημένης ασφάλειας, Αντικρηκτική) στη σελίδα 23.
- Για τις απαιτήσεις καλωδίωσης, ακολουθείτε τους τοπικούς κανονισμούς.
- Βλέπε επίσης Οδηγίες ειδικά για εγκαταστάσεις σε επικίνδυνες περιοχές στη σελίδα 13 και το πιστοποιητικό ATEX που παρατίθεται πιο πάνω.

Ελληνικά



2. Καλωδίωση αυξημένης ασφάλειας

SIEMENS			 II 1/2 G EEx emia IIC T4 SIRA 05ATEX1001X 0682 0518	 HART Um=250V
SITRANS LR200 7ML1234-56789-0ABC-D SerialNo: GYZ/S1034567 Encl.: NEMA/TYPE 4X, 6, IP67, IP68 Amb. Temp.: -40°C to 80°C Power Rating: 24V --- Nom., 30V --- Max., 4-20mA Siemens Milltronics Process Instruments Inc., Peterborough Made in Canada				

Είδος έγκρισης	Έγκυρο για:	Αναφορά
ATEX II 1/2 G, EEx em ia IIC T4	Ευρώπη	Flameproof/Increased Safety: ATEX Certificate στη σελίδα A-1.

- Για τις απαιτήσεις ισχύος, βλέπε *Καμπύλη 2 (Πυρίμαχη, Αυξημένης ασφάλειας, Αντιεκρηκτική)* στη σελίδα 23.
- Για τις απαιτήσεις καλωδίωσης, ακολουθείτε τους τοπικούς κανονισμούς.
- Βλέπε επίσης *Οδηγίες ειδικά για εγκαταστάσεις σε επικίνδυνες περιοχές* στη σελίδα 13 και το πιστοποιητικό ATEX που παρατίθεται πιο πάνω.

3. Αντιεκρηκτική καλωδίωση (FM/CSA, Η.Π.Α./Καναδάς μόνο)

SIEMENS			 FCC ID: NJA-LR 200 CANADA: 267P-LR 200 HART  159134
SITRANS LR200 7ML1234-56789-0ABC-D SerialNo: GYZ/S1034567 Encl.: NEMA/TYPE 4X, 6, IP67, IP68 Amb. Temp.: -40°C to 80°C Power Rating: 24V --- Nom., 30V --- Max., 4-20mA Siemens Milltronics Process Instruments Inc., Peterborough Made in Canada			

Είδος έγκρισης	Έγκυρο για:	Αναφορά
FM/CSA: Κλάση I, Τμ. 1, Ομάδες A, B, C, D Κλάση II, Τμ. 1, Ομάδες E, F, G Κλάση III T4	Η.Π.Α./ Καναδάς	Αντιεκρηκτική FM/CSA, αριθμός διαγράμματος συνδέσεων 23650597

- Για τις απαιτήσεις ισχύος, βλέπε *Καμπύλη 2 (Πυρίμαχη, Αυξημένης ασφάλειας, Αντιεκρηκτική)* στη σελίδα 23.
- Για τις απαιτήσεις καλωδίωσης (Βόρειος Αμερική μόνο), ανατρέξτε στο διάγραμμα συνδέσεων που παρατίθεται πιο πάνω, που μπορεί να ληφθεί από τη σελίδα προϊόντων της τοποθεσίας μας web στο Διαδίκτυο: www.siemens.com/LR200.

4. Μη εμπρηστική καλωδίωση (FM/Η.Π.Α. μόνο)

SIEMENS	FM APPROVED	Class I, Div. 2, Group A, B, C, D Temp. Code: T5
7ML1234-56789-0ABC-D Serial No: GYZ/S1034567 Encl.: NEMA / TYPE 4X, 6, IP67 Amb. Temp.: -40 °C to 80 °C Power Rating: 24V ~~~ Nom., 30V ~~~ Max., 4-20mA	CANADA: 267P- FCC ID: NJA-LR200	
Siemens Milltronics Process Instruments Inc., Peterborough Made in Canada	This device complies with Part 15 of the FCC Rules. Operation is subject to the following two conditions 1) This device may not cause harmful interference and 2) This device must accept any interference received, including interference that may cause undesired operation	

Είδος έγκρισης	Έγκυρο για:	Αναφορά
FM: Κλάση I, Τμ. 2, Ομάδες A, B, C, D T5	US	Μη εμπρηστική FM, αριθμός διαγράμματος συνδέσεων 23650537

- Για τις απαιτήσεις ισχύος, βλέπε *Καμπύλη 1 (Γενικής χρήσης, Ενδογενώς ασφαλής, Μη εμπρηστική)* στη σελίδα 23.
- Για τις απαιτήσεις καλωδίωσης (Βόρειος Αμερική μόνο), ανατρέξτε στο διάγραμμα συνδέσεων που παρατίθεται πιο πάνω, που μπορεί να ληφθεί από τη σελίδα προϊόντων της τοποθεσίας μας web στο Διαδίκτυο: www.siemens.com/LR200.

5. Ενδογενώς ασφαλής καλωδίωση:

SIEMENS	Class I, Div 1, Group A, B, C, D Class II, Div 1, Group E, F, G Class III Temp. Code: T4 HART	Vmax = 30 V Imax = 120 mA Pmax = 0.9 W Ci = 15 nF Li = 0.1 mH	159134 FM APPROVED
SITRANS LR200 7ML1234-56789-0ABC-D Serial No: GYZ/S1034567 Encl.: NEMA / TYPE 4X, 6, IP67, IP68 Amb. Temp.: -40 °C to 80 °C Power Rating: 24V ~~~ Nom., 30V ~~~ Max., 4-20mA	Siemens Milltronics Process Instruments Inc., Peterborough Made in Canada	CSA per drawing A5E01003039 FM per drawing A5E01003040 WARNING: Possible Static Hazard, Do Not Rub Or Clean On Site	
SIEMENS	II 1 G, EEx ia IIC T4 SIRA 06ATEX2378X 9892 9516 HART 5.8 GHz	Ui = 30 V Ii = 120 mA Pi = 0.8 W Ci = 15 nF Li = 0.1 mH	IECEx TSA 04.0020X ANZEx 04.3016X Ex ia IIC T4 N117
SITRANS LR200 7ML1234-56789-0ABC-D Serial No: GYZ/S1034567 Encl.: NEMA / TYPE 4X, 6, IP67, IP68 Amb. Temp.: -40 °C to 80 °C Power Rating: 24V ~~~ Nom., 30V ~~~ Max., 4-20mA	Siemens Milltronics Process Instruments Inc., Peterborough Made in Canada	WARNING: Possible Static Hazard, Do Not Rub Or Clean On Site.	Significance N117

Είδος έγκρισης	Έγκυρο για:	Αναφορά
FM/CSA: Κλάση I, Τμ. 1, Ομάδες A, B, C, D Κλάση II, Τμ. 1, Ομάδες E, F, G Κλάση III	Η.Π.Α./Καναδάς	Ενδογενώς ασφαλής FM, αριθμός διαγράμματος συνδέσεων A5E01003040 Ενδογενώς ασφαλής CSA, αριθμός διαγράμματος συνδέσεων A5E01003039
ATEX II 1 G, EEx ia IIC T4	Ευρώπη	<i>Intrinsically Safe: ATEX Certificate</i> στη σελίδα A-5
ANZEX Ex ia IIC T4 (Θπερ. = -40 έως 80 °C) IP67	Αυστραλία	
IECEX TSA 04.0020X	Διεθνής	

- Για τις απαιτήσεις ισχύος, βλέπε *Καμπύλη 1 (Γενικής χρήσης, Ενδογενώς ασφαλής, Μη εμπρηστική)* στη σελίδα 23.

ΕΛΛΗΝΙΚΑ

- Για τις απαιτήσεις καλωδίωσης:
 - Β. Αμερική: Ανατρέξτε στα διαγράμματα συνδέσεων που παρατίθενται πιο πάνω, που μπορούν να ληφθούν από τη σελίδα προϊόντων της τοποθεσίας μας web στο Διαδίκτυο: www.siemens.com/LR200.
 - Ευρώπη: Ακολουθείτε τους τοπικούς κανονισμούς.
 - Αυστραλία: Ακολουθείτε τους τοπικούς κανονισμούς.
 - Διεθνώς: Ακολουθείτε τους τοπικούς κανονισμούς.
- Χρησιμοποιήστε κατάλληλα στεγανοποιητικά αγωγών για τη διατήρηση της ταξινόμησης IP ή NEMA.
- Συνιστώμενα ενδογενώς ασφαλή φράγματα παρατίθενται στην παράγραφο **Παθητικά φράγματα (διατάξεις προστασίας) με δίοδο διακλάδωσης** στη σελίδα 12.
- Ανατρέξτε επίσης στις **Οδηγίες ειδικά για εγκαταστάσεις σε επικίνδυνες περιοχές** στη σελίδα 13 και στο πιστοποιητικό ATEX που παρατίθεται πιο πάνω.

Σημείωση: Η επιλογή κατάλληλης μονάδας εισόδου PLC, τροφοδοτικού ή φράγματος απαιτεί γνώσεις για την Ενδογενή Ασφάλεια και την εφαρμογή. Αποτελεί ευθύνη του τεχνικού εγκατάστασης να εξασφαλίσει ότι η ενδογενώς ασφαλής εγκατάσταση συμμορφώνεται τόσο με τις απαιτήσεις έγκρισης της συσκευής όσο και με το σχετικό εθνικό κώδικα πρακτικής.

Παθητικά φράγματα (διατάξεις προστασίας) με δίοδο διακλάδωσης

Σημείωση: Απαιτείται καλά ρυθμιζόμενη τάση τροφοδοσίας.

Κατασκευαστής	Κωδικός είδους
MTL	787SP+ (διπλό κανάλι)
MTL	7787P+ (διπλό κανάλι)
Stahl	9001/01-280-100-10 (μονό κανάλι)
Stahl	9002/01-280-110-10 (διπλό κανάλι)

Πώς να επιλέξετε ένα παθητικό φράγμα για το SITRANS LR200

Για να βεβαιωθείτε ότι η περιγραφή της ασφάλειας φράγματος είναι κατάλληλη για τις παραμέτρους εισόδου Ενδογενώς Ασφαλούς (IS) LR200, κάντε τους εξής υπολογισμούς:

- Rτερμ. = μέγ. θερματική αντίσταση του φράγματος
- Rβρ. = αντίσταση βρόχου (άθροισμα αντίστασης καλωδίου συν π.χ. αντίσταση ανίχνευσης, οθόνες και/ή εισοδοί PLC)
- Vφρ. = τιμή οποιασδήποτε μη γραμμικής πτώσης τάσης εξαιτίας του φράγματος

- 1) Προσδιορίστε την τιμή της Rτερμ. από το φύλλο δεδομένων.
- 2) Υπολογίστε την ολική τιμή της Rβρ.: προσθέτοντας για παράδειγμα, την αντίσταση ανίχνευσης, τις οθόνες και/ή εισόδους PLC.
- 3) Υπολογίστε την Rεργασίας = Rτερμ. + Rβρ.

- 4) Προσδιορίστε την τιμή της Vφρ. από το φύλλο δεδομένων φραγμάτων (για παράδειγμα, πτώσεις τάσης στις διόδους).
- 5) Υπολογίστε την Vεργασίας = Vτροφ. – Vφρ.

Χρησιμοποιήστε τις τιμές για την Vεργασίας και την Vεργασίας για να βεβαιωθείτε ότι η συσκευή λειτουργεί εντός της γραμμοσκιασμένης περιοχής της γραφικής παράστασης *Καμπύλη 1 (Γενικής χρήσης, Ενδογενώς ασφαλής, Μη εμπρηστική)* στη σελίδα 23.

Σημειώσεις:

- Η παρακάτω λίστα δεν είναι πλήρης: υπάρχουν πολλά τροφοδοτικά και φράγματα IS στην αγορά που λειτουργούν με το LR200.
- Οι μονάδες εισόδου PLC και τα φράγματα που παρατίθενται παρακάτω έχουν ελεγχθεί και είναι συμβατά, από άποψη λειτουργίας, με το LR200.

Ενεργά φράγματα (επαναληπτικά φράγματα)

Κατασκευαστής	Κωδικός είδους
MTL	706
MTL	7206
Stahl	9001/51-280-110-14
Pepperl+Fuchs	KSD2-CI-S-Ex
Pepperl+Fuchs	KFD2-STC3-Ex1
MTL	E02009 - επαλήθευση
MTL	E02010

Οδηγίες ειδικά για εγκαταστάσεις σε επικίνδυνες περιοχές

(Κωδικός Ευρωπαϊκής Οδηγίας ATEX 94/9/ΕΚ, Παράρτημα II, 1/0/6)

Οι οδηγίες που ακολουθούν ισχύουν για εξοπλισμό που καλύπτεται από τους αριθμούς πιστοποιητικών SIRA 06ATEX2378X, SIRA 05ATEX1001X:

- 1) Για τη χρήση και τη συναρμολόγηση, ανατρέξτε στις βασικές οδηγίες.
- 2) Ο εξοπλισμός έχει πιστοποιηθεί για χρήση ως εξοπλισμός κατηγορίας 1G.
- 3) Ο εξοπλισμός μπορεί να χρησιμοποιηθεί με εύφλεκτα αέρια και ατμούς με συσκευές των ομάδων IIC, IIB και IIA και κατηγορίες θερμοκρασιών T1, T2, T3 και T4.
- 4) Ο εξοπλισμός έχει πιστοποιηθεί για χρήση σε περιοχή θερμοκρασιών περιβάλλοντος από –40° C έως +80° C.
- 5) Ο εξοπλισμός δεν έχει αξιολογηθεί ως συσκευή που σχετίζεται με την ασφάλεια (όπως αναφέρεται στην Οδηγία 94/9/ΕΚ, Παράρτημα II, παράγραφος 1.5).
- 6) Η εγκατάσταση και η επιθεώρηση του παρόντος εξοπλισμού θα πρέπει να πραγματοποιείται από κατάλληλα εκπαιδευμένο προσωπικό, σύμφωνα με τον εφαρμοστέο κώδικα πρακτικής (EN 60079-14 και EN 60079-17 στην Ευρώπη).

- 7) Ο εξοπλισμός δεν επιδέχεται επισκευή.
- 8) Οι αριθμοί πιστοποιητικών φέρουν το πρόθεμα «X», το οποίο υποδηλώνει ότι ισχύουν ειδικές συνθήκες ασφαλούς λειτουργίας. Τα άτομα που εγκαθιστούν ή επιθεωρούν τον εξοπλισμό αυτόν πρέπει να έχουν πρόσβαση στα πιστοποιητικά.
- 9) Αν είναι πιθανόν να έλθει ο εξοπλισμός σε επαφή με διαβρωτικές ουσίες, τότε συνιστά ευθύνη του χρήστη να λάβει τις κατάλληλες προφυλάξεις για να αποφευχθεί τυχόν ανεπανόρθωτη βλάβη του, διασφαλίζοντας κατ' αυτόν τον τρόπο ότι δεν διακυβεύεται ο τύπος προστασίας.

Διαβρωτικές ουσίες: π.χ. όξινα υγρά ή αέρια που μπορεί να διαβρώσουν μέταλλα ή διαλύτες που ενδέχεται να επιδράσουν σε πολυμερή υλικά.

Κατάλληλες προφυλάξεις: για παράδειγμα, εξακριβώστε από το φύλλο δεδομένων υλικών ότι παρουσιάζουν αντοχή σε συγκεκριμένες χημικές ουσίες.

Ενεργοποίηση του SITRANS LR200

Τροφοδοτήστε τη συσκευή με ρεύμα. Το SITRANS LR200 ξεκινά αυτόματα στη λειτουργία Measurement (Μέτρηση). (Για να αλλάξετε τη γλώσσα της οθόνης, ανατρέξτε στην παράγραφο *Πραγματοποίηση επιλογής (για παράδειγμα, επιλογή γλώσσας)* στη σελίδα 17.)

Η οθόνη LCD

Λειτουργία Measurement (Μέτρηση) (κανονική λειτουργία)

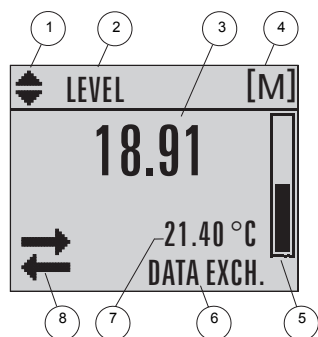

- 1 – ενδεικτικό εναλλαγής για γραμμικές μονάδες ή %
- 2 – επιλεγμένη λειτουργία: level (στάθμη), space (κενός χώρος) ή distance (απόσταση)
- 3 – τιμή μέτρησης (στάθμη ή όγκος, κενός χώρος ή απόσταση)
- 4 – μονάδες
- 5 – το ραβδόγραμμα υποδεικνύει τη στάθμη
- 6 – η δευτερεύουσα περιοχή υποδεικνύει, κατόπιν αίτησης¹⁾, τη θερμοκρασία των ηλεκτρονικών, την αξιοπιστία της ηχούς, το ρεύμα βρόχου ή την απόσταση
- 7 – η περιοχή κειμένου εμφανίζει μηνύματα κατάστασης
- 8 – ενδεικτικό κατάστασης συσκευής

Υπάρχει βλάβη



S: 0 LOE

- 7 – η περιοχή κειμένου εμφανίζει έναν κωδικό βλάβης και ένα μήνυμα σφάλματος
- 8 – εμφανίζεται το εικονίδιο αναγκαιότητας σέρβις

Λειτουργία PROGRAM

Προβολή Navigation (Πλοήγηση)

- Μια ορατή ενδεικτική στήλη μενού υποδεικνύει ότι η λίστα μενού είναι πολύ μακριά, ώστε να είναι δυνατή η εμφάνιση όλων των στοιχείων.
- Βαθύτερο στοιχείο μενού αναπαριστά μικρότερη λίστα μενού.

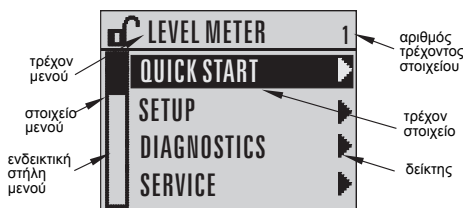

¹⁾ Ύστερα από κατάλληλο πάτημα πλήκτρου: βλέπε *Λειτουργίες πλήκτρων στη λειτουργία Measurement (Μέτρηση)* στη σελίδα 15.

Προβολή παραμέτρου

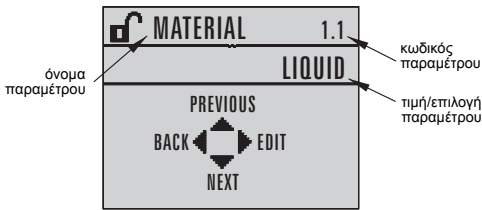

Προβολή Edit (Επεξεργασία)

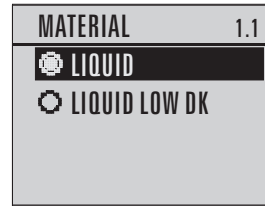

Φορητός προγραμματιστής





(Κωδ. είδους. 7ML1930-1BK)

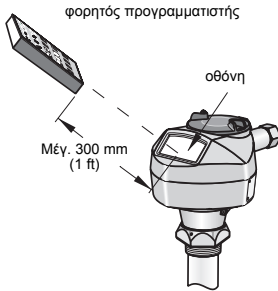



Ο προγραμματιστής παραγγέλνεται ξεχωριστά.

- Στρέψτε τον προγραμματιστή προς την οθόνη (από μέγιστη απόσταση 300 mm [1 ft.]).
- Πίεστε  Mode (Τρόπος λειτουργίας) για εναλλαγή μεταξύ των λειτουργιών Measurement (Μέτρηση) και PROGRAM.



Λειτουργίες πλήκτρων στη λειτουργία Measurement (Μέτρηση)

Πλήκτρο	Λειτουργία	Αποτέλεσμα
	Το πλήκτρο Mode ανοίγει τη λειτουργία PROGRAM.	Ανοίγει το επίπεδο μενού που εμφανίστηκε τελευταίο σε αυτόν τον κύκλο τροφοδοσίας ή το 1ο επίπεδο μενού, εκτός αν η τροφοδοσία διακόπηκε και επαναφέρθηκε μετά την έξοδο από τη λειτουργία PROGRAM ή αν έχουν παρέλθει πάνω από 10 λεπτά από τη χρήση της λειτουργίας PROGRAM.
	Το ΔΕΞΙ βέλος ανοίγει τη λειτουργία PROGRAM.	Ανοίγει το 1ο επίπεδο μενού.
 	Το ΠΑΝΩ ή ΚΑΤΩ βέλος εκτελεί εναλλαγή μεταξύ των γραμμικών μονάδων και του εκατοστιαίου ποσοστού.	Η οθόνη LCD απεικονίζει τη μετρηθείσα τιμή είτε σε γραμμικές μονάδες είτε σε εκατοστιαίο ποσοστό.

Πλήκτρο	Λειτουργία	Αποτέλεσμα
	Ενημερώνει το ρεύμα βρόχου.	Νέα τιμή εμφανίζεται στη δευτερεύουσα περιοχή της LCD.
	Ενημερώνει την ένδειξη της εσωτερικής θερμοκρασίας περιβλήματος.	
	Ενημερώνει την τιμή αξιοπιστίας της ηχούς.	
	Ενημερώνει τη μέτρηση της απόστασης.	

Προγραμματισμός του SITRANS LR200

Σημείωση: Το SITRANS LR200 επιστρέφει αυτόματα στη λειτουργία Measurement (Μέτρηση) ύστερα από κάποια περίοδο αδράνειας στη λειτουργία PROGRAM (μεταξύ 15 δευτερολέπτων και 10 λεπτών, ανάλογα με το επίπεδο του μενού).

Οι ρυθμίσεις μπορούν να τροποποιηθούν τοπικά μέσω της τοπικής διεπαφής χρήστη ή εξ αποστάσεως μέσω του SIMATIC PDM. Η τοπική διεπαφή χρήστη (LUI) αποτελείται από μια οθόνη LCD και από ένα φορητό προγραμματιστή.

- Βλέπε *Οδηγός Γρήγορης Έναρξης μέσω του φορητού προγραμματιστή* στη σελίδα 18.
- Βλέπε *Οδηγός Γρήγορης Έναρξης μέσω SIMATIC PDM* στη σελίδα 21.

Μενού παραμέτρων

Σημείωση: Για την πλήρη λίστα παραμέτρων με οδηγίες, ανατρέξτε στο πλήρες εγχειρίδιο. Μπορεί να ληφθεί από τη σελίδα προϊόντων της τοποθεσίας μας web στο Διαδίκτυο: www.siemens.com/LR200.

Οι παράμετροι αναγνωρίζονται με βάση το όνομα και οργανώνονται σε ομάδες λειτουργίας και, στη συνέχεια, διευθετούνται σε μια δομή μενού 5 επιπέδων.

1. QUICK START

2. SETUP

3. DIAGNOSTICS

3.14. MEAS. VALUES

3.14.1. CURR. INTERN. TEMP.

Προσπέλαση παραμέτρων μέσω του φορητού προγραμματιστή

1. Μετάβαση στη λειτουργία PROGRAM

- Στρέψτε τον προγραμματιστή προς την οθόνη από μέγιστη απόσταση 300 mm (1 ft).
- Πατήστε το **ΔΕΞΙ βέλος**  για να ανοίξει το 1ο επίπεδο μενού.

2. Πλοήγηση: λειτουργίες πλήκτρων στη λειτουργία Πλοήγηση

Πλήκτρο	Όνομα	Επίπεδο μενού	Λειτουργία
	ΠΑΝΩ ή ΚΑΤΩ βέλος	μενού ή παράμετρος	• Μετάβαση στο προηγούμενο ή στο επόμενο μενού ή παράμετρο.
	ΔΕΞΙ βέλος	μενού	• Μετάβαση στην πρώτη παράμετρο του επιλεγμένου μενού
		παράμετρος	• ή άνοιγμα του επόμενου μενού.
	ΑΡΙΣΤΕΡΟ βέλος	μενού ή παράμετρος	• Άνοιγμα μενού ανώτερου επιπέδου.
	Mode (<i>Τρόπος λειτουργίας</i>)	μενού ή παράμετρος	• Μετάβαση στη λειτουργία MEASUREMENT (ΜΕΤΡΗΣΗ) .
	Home	μενού ή παράμετρος	• Άνοιγμα του 1ου επιπέδου μενού.

3. Επεξεργασία στη λειτουργία PROGRAM

Πραγματοποίηση επιλογής (για παράδειγμα, επιλογή γλώσσας)

a) Μεταβείτε στο **Language (Γλώσσα) (7)**.

b) Πατήστε το **ΔΕΞΙ βέλος** για να ανοίξει η προβολή παραμέτρου.

c) Πατήστε ξανά το **ΔΕΞΙ βέλος** για να ανοίξει η λειτουργία **Edit (Επεξεργασία)**. Φωτίζεται η τρέχουσα επιλογή.

d) Μεταβείτε σε νέα επιλογή.

Πατήστε το **ΔΕΞΙ βέλος** για να την αποδεχθείτε. Η οθόνη LCD επιστρέφει στην προβολή παραμέτρου και εμφανίζει τη νέα επιλογή.

e) Πατήστε το **ΑΡΙΣΤΕΡΟ βέλος** για να επιστρέψετε στο μενού.

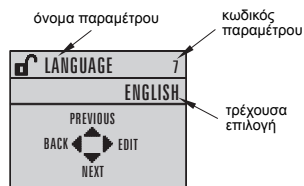



Αλλαγή αριθμητικής τιμής

a) Μεταβείτε στην επιθυμητή παράμετρο.

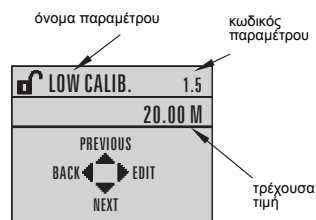
b) Πατήστε το **ΔΕΞΙ βέλος** για να ανοίξει η προβολή παραμέτρου. Εμφανίζεται η τρέχουσα τιμή.







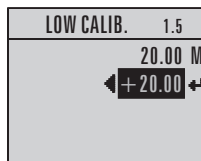

- c) Πατήστε ξανά το **ΔΕΞΙ βέλος**  για να ανοίξει η λειτουργία **Edit (Επεξεργασία)**. Φωτίζεται η τρέχουσα τιμή.
- d) Πληκτρολογήστε νέα τιμή και πατήστε το **ΔΕΞΙ**

βέλος  για να την αποδεχθείτε.

Η οθόνη LCD επιστρέφει στην προβολή παραμέτρου και εμφανίζει τη νέα επιλογή.





Λειτουργίες πλήκτρων στη λειτουργία Edit (Επεξεργασία)





Πλήκτρο	Όνομα	Λειτουργία
	ΠΑΝΩ ή ΚΑΤΩ βέλος	Πραγματοποίηση επιλογών <ul style="list-style-type: none"> Εκτελεί μετάβαση σε κάποιο στοιχείο.
		Επεξεργασία αριθμητικών τιμών <ul style="list-style-type: none"> Εκτελεί βηματική αύξηση ή μείωση ψηφίων Εκτελεί εναλλαγή μεταξύ θετικού/αρνητικού πρόσημου
	ΔΕΞΙ βέλος	Πραγματοποίηση επιλογών <ul style="list-style-type: none"> Αποδέχεται τα δεδομένα (εγγράφει την παράμετρο) Εκτελεί μετάβαση από τη λειτουργία Επεξεργασία στη λειτουργία Πλοήγηση
		Επεξεργασία αριθμητικών τιμών <ul style="list-style-type: none"> Μετακινεί το δρομέα ένα διάστημα προς τα δεξιά ή με το δρομέα στο σύμβολο Enter αποδέχεται τα δεδομένα και εκτελεί μετάβαση από τη λειτουργία Επεξεργασία στη λειτουργία Πλοήγηση
	ΑΡΙΣΤΕΡΟ βέλος	Πραγματοποίηση επιλογών <ul style="list-style-type: none"> Ακυρώνει τη λειτουργία Επεξεργασία χωρίς αλλαγή της παραμέτρου
		Επεξεργασία αριθμητικών τιμών <ul style="list-style-type: none"> Μετακινεί το δρομέα στο θετικό/αρνητικό πρόσημο, αν αυτό το πλήκτρο πατηθεί πρώτο ή μετακινεί το δρομέα ένα διάστημα προς τα αριστερά.
	Απαλοιφή	Επεξεργασία αριθμητικών τιμών <ul style="list-style-type: none"> Σβήνει την οθόνη.
	Υποδιαστολή	Επεξεργασία αριθμητικών τιμών <ul style="list-style-type: none"> Εισάγει μια υποδιαστολή.
	Θετικό/αρνητικό πρόσημο	Επεξεργασία αριθμητικών τιμών <ul style="list-style-type: none"> Αλλάζει το πρόσημο της καταχωρημένης τιμής.
	Αριθμητικός	Επεξεργασία αριθμητικών τιμών <ul style="list-style-type: none"> Εισάγει τον αντίστοιχο χαρακτήρα.

Οδηγός Γρήγορης Έναρξης μέσω του φορητού προγραμματιστή

Σημείωση: Κάθε φορά που ξεκινά ο Οδηγός Γρήγορης Έναρξης, οι ρυθμίσεις εκκίνησης είναι οι εργοστασιακά προεπιλεγμένες τιμές. Ο Οδηγός δεν ανακαλεί από τη μνήμη τις προηγούμενες, καθορισμένες από το χρήστη ρυθμίσεις.

1. Γρήγορη Έναρξη

- Στρέψτε τον προγραμματιστή προς την οθόνη (από μέγιστη απόσταση 300 mm [1 ft.]), μετά πατήστε το **ΔΕΞΙ βέλος**  για να ενεργοποιήσετε τη λειτουργία PROGRAM και να ανοίξετε το 1ο επίπεδο μενού.
- Πατήστε το **ΔΕΞΙ βέλος**  δύο φορές για να μεταβείτε στο στοιχείο μενού 1.1 και να ανοίξετε την προβολή παραμέτρου.

- c) Πατήστε το **ΔΕΞΙ βέλος**  για να ανοίξετε τη λειτουργία **Επεξεργασία** ή το **ΚΑΤΩ βέλος**  για να αποδεχθείτε τις προεπιλεγμένες τιμές και να μεταβείτε απευθείας στο επόμενο στοιχείο.
- d) Για να αλλάξετε κάποια ρύθμιση, μεταβείτε στο επιθυμητό στοιχείο ή πληκτρολογήστε μια νέα τιμή.
- e) Αφού αλλάξετε κάποια τιμή, πατήστε το **ΔΕΞΙ βέλος**  για να την αποδεχθείτε και το **ΚΑΤΩ βέλος**  για να μεταβείτε στο επόμενο στοιχείο.
- f) Οι ρυθμίσεις Γρήγορης Έναρξης τίθενται σε ισχύ μόνο εφόσον επιλέξετε **Yes (Ναι)** στο **Apply changes (Εφαρμογή αλλαγών)** στο βήμα 1.7.

1.1. Υλικό

Επιλογές	LIQUID (ΥΓΡΟ)
	LIQUID LOW DK (υγρό μικρής διηλεκτρικής σταθεράς)

1.2. Ρυθμός απόκρισης

Ρυθμίζει την ταχύτητα απόκρισης της συσκευής στις μεταβολές μέτρησης εντός της προγραμματισμένης περιοχής τιμών μέτρησης.

Επιλογές	SLOW (ΑΡΓΟΣ)	0,1 m/min
	MED (ΜΕΣΑΙΟΣ)	1,0 m/min
	FAST (ΓΡΗΓΟΡΟΣ)	10,0 m/min

Χρησιμοποιήστε μια ρύθμιση λίγο υψηλότερη από το μέγιστο ρυθμό πλήρωσης ή κένωσης (όποιος από τους δύο είναι μεγαλύτερος).

1.3. Μονάδες αισθητήρα

Επιλέγει τις μονάδες για τις μεταβλητές της Γρήγορης Έναρξης (άνω και κάτω σημείο βαθμονόμησης καθώς και στάθμη, απόσταση ή κενός χώρος).

Επιλογές	M, CM, MM, FT, IN
----------	-------------------

1.4. Λειτουργία

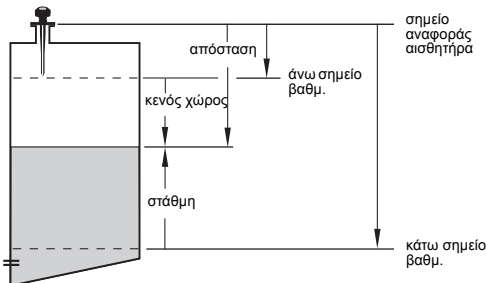

Τρόποι λειτουργίας	NO SERVICE (ΠΑΓΩΜΑ ΛΕΙΤΟΥΡΓΙΑΣ)	Το SITRANS LR200 σταματά την ενημέρωση των μετρήσεων και του σχετικού ρεύματος βρόχου. Απεικονίζεται η τελευταία έγκυρη μέτρηση.
	LEVEL (ΣΤΑΘΜΗ)	Απόσταση έως την επιφάνεια του υλικού με σημείο αναφοράς το Κάτω Σημείο Βαθμονόμησης (μηδενική στάθμη διεργασίας).
	SPACE (ΚΕΝΟΣ ΧΩΡΟΣ)	Απόσταση έως την επιφάνεια του υλικού με σημείο αναφοράς το Άνω Σημείο Βαθμονόμησης (πλήρη στάθμη διεργασίας).
	DISTANCE (ΑΠΟΣΤΑΣΗ)	Απόσταση έως την επιφάνεια του υλικού με σημείο αναφοράς το Σημείο Αναφοράς Αισθητήρα.

1.5. Κάτω Σημείο Βαθμονόμησης

Απόσταση από το Σημείο Αναφοράς Αισθητήρα έως το Κάτω Σημείο Βαθμονόμησης: συνήθως είναι η μηδενική στάθμη διεργασίας.

Τιμές	Εμβέλεια: 0,0000 έως 20.000 m
-------	-------------------------------

1.6. Άνω Σημείο Βαθμονόμησης

Απόσταση από το Σημείο Αναφοράς Αισθητήρα έως το Άνω Σημείο Βαθμονόμησης: συνήθως είναι η μέγιστη στάθμη διεργασίας.

Τιμές	Εμβέλεια: 0,0000 έως 20.000 m
-------	-------------------------------

1.7. Apply? (Εφαρμογή αλλαγών)

Για να αποθηκεύσετε τις ρυθμίσεις Γρήγορης Έναρξης, πρέπει να επιλέξετε **Yes** (Ναι) για εφαρμογή των αλλαγών.

Επιλογές	YES (ΝΑΙ), NO (ΟΧΙ)
----------	---------------------



Η οθόνη δείχνει **DONE** (ΕΚΤΕΛΕΣΤΗΚΕ) όταν η Γρήγορη Έναρξη ολοκληρωθεί με επιτυχία.



Πατήστε το πλήκτρο **Mode**  για να επιστρέψετε στη λειτουργία Measurement (Μέτρηση). Το SITRANS LR200 είναι πλέον έτοιμο να λειτουργήσει.

Αίτηση προφίλ ηχούς

1) Ενώ βρίσκεστε στη λειτουργία PROGRAM, μεταβείτε στο: **Level Meter** (Μετρητής στάθμης) > **Diagnostics** (Διαγνωστικός έλεγχος) (3) > **Echo Profile** (Προφίλ ηχούς) (3.1).

2) Πατήστε το **ΔΕΞΙ βέλος**  για να ζητήσετε ένα προφίλ.

3) Στην οθόνη Profile (Προφίλ), πατήστε το **ΠΑΝΩ βέλος**  για να επιλέξετε το εικονίδιο **Transmit** (Εκπομπή) και το **ΔΕΞΙ βέλος**  για να ενημερώσετε το προφίλ.

4) Πατήστε το **ΚΑΤΩ βέλος**  για να επιλέξετε το εικονίδιο **Exit** (Εξόδος) και μετά το **ΔΕΞΙ βέλος**  για να επιστρέψετε στο προηγούμενο μενού.

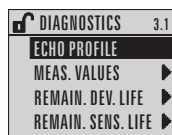

εικονίδιο εκπομπής, αποεπιλεγμένο

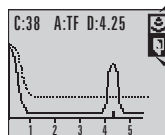

εικονίδιο εξόδου, επιλεγμένο



εικονίδιο εκπομπής, επιλεγμένο

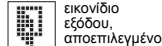

εικονίδιο εξόδου, αποεπιλεγμένο

Επικοινωνίες του SITRANS LR200 HART

- Θα χρειαστείτε το πλήρες εγχειρίδιο για να δείτε τον κατάλογο όλων των παραμέτρων.
- Σας συνιστούμε να χρησιμοποιήσετε το SIMATIC Process Device Manager (PDM) για να προγραμματίσετε τη συσκευή σας.

SIMATIC PDM

Σημειώσεις:

- Σας συνιστούμε να χρησιμοποιήσετε την αναθεωρημένη έκδοση 6.0 SP3 του SIMATIC PDM ή ανώτερη έκδοση.
- Η αναθεωρημένη έκδοση 5.2 SP1 του SIMATIC PDM υποστηρίζεται μόνο για τις βασικές ρυθμίσεις παραμέτρων και την επίλυση προβλημάτων. Για προηγμένες λειτουργίες, όπως ο Οδηγός Γρήγορης Έναρξης, απαιτείται η αναθεωρημένη έκδοση 6.0 SP3 ή ανώτερη έκδοση.

Το SIMATIC PDM είναι ένα πακέτο λογισμικού που χρησιμοποιείται για να θέσει σε λειτουργία και να διαχειριστεί τη συσκευή SITRANS LR200 και λοιπές συσκευές διεργασίας. Για λεπτομέρειες σχετικά με τη χρήση του SIMATIC PDM, συμβουλευθείτε τις οδηγίες λειτουργίας ή την ηλεκτρονική βοήθεια. (Περισσότερες πληροφορίες μπορείτε να βρείτε στην ιστοσελίδα www.siemens.com/simatic-pdm. Μεταβείτε στο **Products and Solutions** (Προϊόντα και λύσεις) > **Products and Systems** (Προϊόντα και συστήματα) > **Communications and Software** (Επικοινωνίες και λογισμικό) > **Process Device Manager** (Διαχείριση συσκευών διεργασίας)).

Περιγραφή ηλεκτρονικής συσκευής (EDD)

- Μπορείτε να εντοπίσετε την EDD στο Device Catalog (*Κατάλογος συσκευών*), στο **Sensors/Level/Echo/Siemens Milltronics/SITRANS LR200**.
- Ελέγξτε στη σελίδα προϊόντων της τοποθεσίας μας web στο Διαδίκτυο: www.siemens.com/LR200 στο **Downloads** (*Λήψεις*), για να βεβαιωθείτε ότι έχετε την πιο πρόσφατη έκδοση του SIMATIC PDM, το πιο πρόσφατο Service Pack (SP) και το πιο πρόσφατο hot fix (HF). Αν χρειαστεί να εγκαταστήσετε νέα EDD, ανατρέξτε στην παράγραφο *Ρύθμιση παραμέτρων νέας συσκευής* πιο κάτω.

Ρύθμιση παραμέτρων νέας συσκευής

Σημείωση: Αν κάνετε κλικ στο **Cancel** (*Ακυρο*) κατά τη διάρκεια μιας αποστολής από τη συσκευή στο SIMATIC PDM, το αποτέλεσμα θα είναι να ενημερωθούν ορισμένες παράμετροι.

1. Βεβαιωθείτε ότι έχετε την πιο πρόσφατη EDD και, αν χρειαστεί, κατεβάστε την από τη σελίδα προϊόντος που παρατίθεται παραπάνω. Αποθηκεύστε τα αρχεία στον υπολογιστή σας και αποσυμπίεστε το συμπιεσμένο αρχείο σε μια θέση του υπολογιστή με εύκολη πρόσβαση. Εκτελέστε το **SIMATIC PDM – Manager Device Catalog** (*Διαχείριση Καταλόγου Συσκευών*), βρείτε το αποσυμπίεσμένο αρχείο EDD και επιλέξτε το.
2. Εκτελέστε το SIMATIC PDM και δημιουργήστε ένα νέο έργο για το LR200. Οι Οδηγοί Εφαρμογής σχετικά με τη ρύθμιση συσκευών HART με SIMATIC PDM μπορούν να ληφθούν από τη σελίδα προϊόντων της τοποθεσίας μας web στο Διαδίκτυο: www.siemens.com/LR200.
3. Φορτώστε τις παραμέτρους στο PC/PG.
4. Ρυθμίστε τις παραμέτρους της συσκευής με τον Οδηγό Γρήγορης Έναρξης (βλέπε πιο κάτω).

Οδηγός Γρήγορης Έναρξης μέσω SIMATIC PDM

Σημειώσεις:

- Οι ρυθμίσεις του Οδηγού Γρήγορης Έναρξης είναι αλληλοσχετιζόμενες και οι αλλαγές ενεργοποιούνται μόνον αφότου κάνετε κλικ στο **Transfer** (*Μεταφορά*) στο τέλος του βήματος 5.
- Κάθε φορά που ξεκινά ο Οδηγός Γρήγορης Έναρξης, οι ρυθμίσεις εκκίνησης είναι οι εργοστασιακά προεπιλεγμένες τιμές. Ο Οδηγός δεν ανακαλεί από τη μνήμη τις προηγούμενες, καθορισμένες από το χρήστη ρυθμίσεις.
- Κάντε κλικ στο **BACK** (*ΕΠΙΣΤΡΟΦΗ*) για επιστροφή και επανεξέταση μιας ρύθμισης ή στο **Cancel** (*Ακυρο*) για έξοδο από τη Γρήγορη Έναρξη.

Εκτελέστε το SIMATIC PDM, ανοίξτε το μενού **Device – Quick Start** (*Συσκευή – Γρήγορη Έναρξη*) και εκτελέστε τα βήματα 1 έως 5.

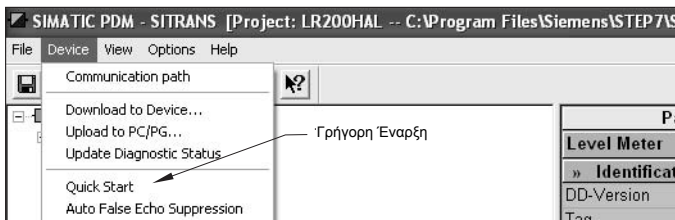

Συντήρηση

Το SITRANS LR200 δεν χρειάζεται συντήρηση ή καθαρισμό υπό κανονικές συνθήκες λειτουργίας. Αν ο καθαρισμός θεωρηθεί απαραίτητος υπό αντίξοες συνθήκες λειτουργίας:

1. Σημειώστε το υλικό κατασκευής της κεραίας και το μέσο της διεργασίας, και επιλέξτε ένα διάλυμα καθαρισμού που δεν θα έχει αρνητική επίδραση σε κάποιο από αυτά.
2. Θέστε τη συσκευή εκτός λειτουργίας και σκουπίστε την κεραία με πανί και κατάλληλο διάλυμα καθαρισμού.

Επισκευή μονάδας και αποκλειόμενη ευθύνη

Για περισσότερες πληροφορίες, ανατρέξτε στην εσωτερική σελίδα του οπισθοφύλλου.

Διάγραμμα μέγιστης τιμής θερμοκρασίας διεργασίας

! ΠΡΟΕΙΔΟΠΟΙΗΣΗ: Η εσωτερική θερμοκρασία δεν πρέπει να υπερβεί τους 80° C (176° F).

Μέγιστες θερμοκρασίες διεργασίας και φλάντζας σε σχέση με την επιτρεπτή θερμοκρασία περιβάλλοντος για εκδόσεις φλαντζωτού προσαρμογέα του SITRANS LR200

- Το διάγραμμα έχει μόνο ενδεικτικό χαρακτήρα.
- Δεν αντιπροσωπεύει κάθε δυνατή διεύθυνση των συνδέσεων διεργασίας. Για παράδειγμα, ΔΕΝ ισχύει αν τοποθετήσετε το SITRANS LR200 απευθείας πάνω στην επιφάνεια ενός μεταλλικού δοχείου.
- Δεν λαμβάνει υπόψη τη θέρμανση από την έκθεση στην άμεση ηλιακή ακτινοβολία.
- Μπορείτε να χρησιμοποιήσετε την παράμετρο 3.14.1 για να παρακολουθείτε την τρέχουσα εσωτερική θερμοκρασία.

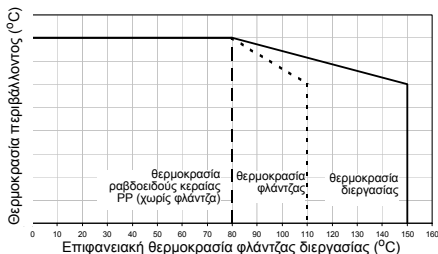

Τροφοδοσία βρόχου

Διάγραμμα τυπικών συνδέσεων

Σημείωση: Η τάση βρόχου είναι η τάση στους ακροδέκτες του τροφοδοτικού (όχι η τάση στους ακροδέκτες της συσκευής).

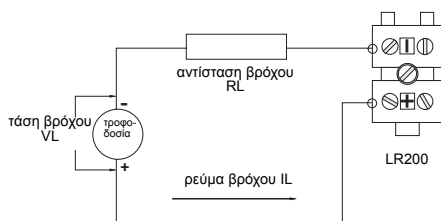

Επιτρεπτή περιοχή λειτουργίας

Καμπύλη 1 (Γενικής χρήσης, Ενδογενώς ασφαλής, Μη εμπρηστική)

Τάση βρόχου – Αντίσταση βρόχου

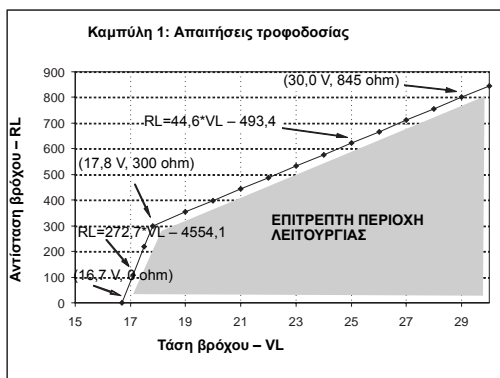

Καμπύλη 2 (Πυρίμαχη, Αυξημένης ασφάλειας, Αντιεκρηκτική)

Τάση βρόχου – Αντίσταση βρόχου

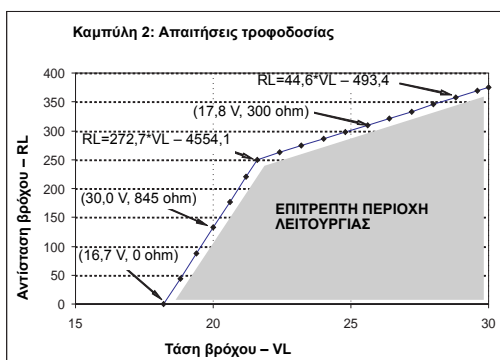

Καμπύλη εκκίνησης

Σημείωση: Κατά την εκκίνηση, μπορεί να χρειαστεί να παρέλθουν από 25 έως 55 δευτερόλεπτα για να αναφέρει η συσκευή την τρέχουσα στάθμη υλικού.

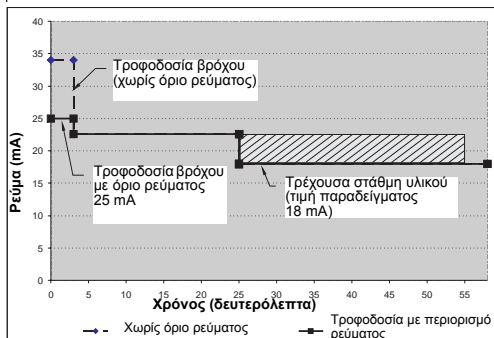

Σημειώσεις

Arranque rápido SITRANS LR200 (HART) con interfaz local LUI Siemens

Este manual contiene indicaciones importantes y condiciones para la utilización del SITRANS LR200 (HART). Le recomendamos encarecidamente que obtenga la versión completa del manual de instrucciones para beneficiarse de todas las funciones del dispositivo. Puede descargar la versión completa del manual de la página SITRANS LR200 de nuestro sitio web: www.siemens.com/LR200. Los manuales también están disponibles en versión impresa - contacte a su representante Siemens Milltronics.

Para más informaciones acerca de este manual contacte:

Siemens Milltronics Process Instruments Inc.
1954 Technology Drive, P.O. Box 4225
Peterborough, Ontario, Canadá, K9J 7B1
E-mail: techpubs.smpi@siemens.com

**Copyright Siemens Milltronics
Process Instruments Inc. 2008.
Todos los derechos reservados**

Exención de responsabilidad

Recomendamos a nuestros usuarios obtengan copias impresas de la documentación o consulten las versiones digitales diseñadas y comprobadas por Siemens Milltronics Process Instruments Inc. En ningún caso será Siemens Milltronics Process Instruments Inc. responsable de reproducciones totales o parciales de la documentación, ya sea de versiones impresas o electrónicas.

Nosotros hacemos todo lo necesario para garantizar la conformidad del contenido de este manual con el equipo proporcionado. Sin embargo, estas informaciones quedan sujetas a cambios. SMPI no asume responsabilidad alguna por omisiones o diferencias. Examinamos y corregimos el contenido de este manual regularmente y nos esforzamos en proporcionar publicaciones cada vez más completas. No dude en contactarnos si tiene preguntas o comentarios.

Las especificaciones están sujetas a cambios.

MILLTRONICS es una marca registrada de Siemens Milltronics Process Instruments Inc.

Soporte Técnico

El soporte está disponible las 24 horas al día. Para encontrar los interlocutores de Siemens Automation en todo el mundo (oficinas, infolines y fax), consulte:

www.siemens.com/automation/partner:

- Haga clic en **Contacts by Product (Interlocutor para productos)** y seleccione un ramo (**+Process Automation > +Process Instrumentation > +Level Measuring Instruments**).
- Seleccione el sector **Technical Support (Soporte técnico)**. Haga clic en **Next (Seguir)**.
- Seleccione el continente, el país y la ciudad. Haga clic en **Next (Seguir)**.

Para soporte online, consulte: www.siemens.com/automation/support-request

- Introduzca el aparato (SITRANS LR200) o el número de pedido, haga clic en **Search (Buscar)**, y seleccione el tipo de producto correspondiente. Haga clic en **Next (Seguir)**.
- Búsqueda por palabra clave: introduzca la palabra. Acceda a la documentación relacionada con el producto o haga clic en **Next (Seguir)** para enviar un mensaje a los servicios de soporte técnico Siemens.

Servicio de soporte técnico Siemens A&D:

Teléfono +49 180 50 50 222

Fax +49 180 50 50 223

Indicaciones de seguridad

Es imprescindible respetar las indicaciones de seguridad para una utilización sin peligro alguno para el usuario, el personal, el producto y los equipos conectados a éste. Por motivos de claridad expositiva en los textos de indicación y de precaución se destaca el nivel de precaución necesario para cada intervención.



ADVERTENCIA: información que se refiere a un marcado colocado en el producto. Significa que al no observar las precauciones de seguridad se puede producir la muerte, lesiones corporales graves o daños materiales considerables.



ADVERTENCIA¹⁾: significa que al no observar las precauciones de seguridad se puede producir la muerte, lesiones corporales graves o daños materiales considerables.

Nota: es una información importante acerca del producto mismo o de la parte respectiva del manual, al cual se debe atender especialmente.

Conformidad FCC

Sólo para EE.UU.: Reglas FCC (Federal Communications Commission)



ADVERTENCIA: Los cambios o modificaciones efectuados sin autorización previa de Siemens Milltronics pueden provocar la anulación de la autorización del usuario a utilizar este aparato.

Indicaciones:

- El instrumento se ha comprobado para garantizar su conformidad con los límites aplicables a los aparatos digitales tipo Clase A, de acuerdo con la Sección 15 de la reglamentación FCC. Estos límites están diseñados para proporcionar una protección razonable contra interferencias perjudiciales cuando el equipo se usa en zonas residenciales.
- Este equipo genera, utiliza y puede radiar energía de frecuencia de radio. Al no observar las indicaciones para la instalación proporcionadas en este manual el equipo puede provocar interferencias dañosas en la comunicación radio. El funcionamiento de este instrumento en entornos residenciales puede provocar interferencias radio perjudiciales. El usuario es el único responsable de corregir las interferencias.

SITRANS LR200



ADVERTENCIA: El SITRANS LR200 debe funcionar únicamente de la manera como se especifica en éste manual. La realización técnica de estas condiciones es la condición para una utilización sin peligro alguno.

Importante: Este aparato se ha diseñado para el uso en ámbito industrial. El uso de este aparato en instalaciones residenciales puede causar interferencias a las comunicaciones por radio.

Transmisor por radar pulsado a 2 hilos SITRANS LR200 de 6 GHz, para la medición de nivel continua de líquidos y lodos en depósitos de almacenamiento o recipientes de proceso. Apropiado para rangos de medida hasta 20 m (66ft) y aplicaciones con presión y temperaturas extremas.

El instrumento consta de una electrónica conectada a la antena de bocina y de una conexión de proceso roscada o bridada.

¹⁾ Símbolo utilizado cuando el producto no lleva marcado de seguridad.

El sistema puede comunicar con el protocolo HART¹⁾. El procesamiento de señales se obtiene con los algoritmos exclusivos Process Intelligence.

Datos técnicos

Para un listado completo, ver la versión completa del manual de instrucciones del SITRANS LR200 (HART). Para más detalles acerca de las Aprobaciones, ver la placa indicadora del aparato.

Temperatura ambiente y de operación

Indicaciones:

- Los límites de temperatura y presión en el proceso pueden variar. Para ello véase la placa de características en el dispositivo. El diagrama de referencia mencionado en la placa se puede descargar del sitio web Siemens: www.siemens.com/LR200www.siemens.com/LR200.
- La máxima temperatura depende de la conexión al proceso, del material de la antena y de la presión en el depósito. Para más detalles ver *Temperaturas máximas de proceso* página 22. Curvas de reducción presión/temperatura de proceso disponibles en la versión completa del manual.

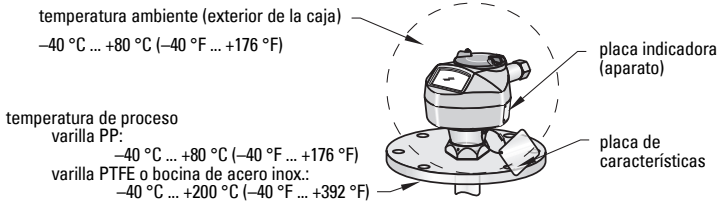

Alimentación



Aplicación general:

Sin riesgo de incendio (FM/EE.UU. únicamente):

Seguridad intrínseca:

Nominal 24 V

DC, 550 ohmios máximo.



Carcasa con resistencia al fuego:

Seguridad aumentada:

A prueba de explosiones (FM/CSA, EE.UU./Canadá únicamente):

Nominal 24 V

DC, 250 ohmios máximo.

Homologaciones

- General CSA_{US/C}, FM, CE
- Radiointerferencia Europa (R&TTE), FCC, Industry Canada

(continúa en la página siguiente)

1) HART[®] es una marca registrada de HART Communication Foundation.

- Zonas clasificadas

Antideflagrante (Europa) ¹⁾	ATEX II 1/2 G, EEx dm ia IIC T4
Seguridad aumentada (Europa) ²⁾	ATEX II 1/2 G, EEx em ia IIC T4
Equipos antideflagrantes, a prueba de explosiones (EE.UU./Canadá) ³⁾	FM/CSA: (sin barrera)
	Clase I, Div. 1, Grupos A, B, C, D
	Clase II, Div. 1, Grupos E, F, G
	Clase III T4

Importante: Para mantener la protección IP/NEMA asegurar la estanqueidad de los conductos.

Homologaciones (cont.)

- Zonas clasificadas

Sin riesgo de incendio (EE.UU.) ⁴⁾	FM: (sin barrera)
	Clase I, Div. 2, Grupos A, B, C, D T5
Seguridad intrínseca ⁵⁾	
(Europa)	ATEX II 1 G, EEx ia IIC T4
(EE.UU./Canadá)	FM/CSA: (requiere barrera de seguridad)
	Clase I, Div. 1, Grupos A, B, C, D
	Clase II, Div. 1, Grupos E, F, G
	Clase III T4
(Australia)	ANZEX Ex ia IIC T4
	(Tamb = -40 ... +80 °C) IP67
(Internacional)	IECEX TSA 04.0020X T4
- Uso naval Lloyd's Register of Shipping
 - Aprobación tipo ABS (American Bureau of Shipping)

Programador (teclado infrarrojos)

Programador portátil por infrarrojos Siemens Milltronics intrínsecamente seguro, para zonas peligrosas y otros tipos de aplicación (pila no reemplazable, con vida útil de 10 años, en condiciones de funcionamiento normal)

- aprobación ATEX II 1 G, EEx ia IIC T4, certificado SIRA 01ATEX2147
- FM/CSA: Clase I, Div. 1, Grupos A, B, C, D
- temperatura ambiente -20 ... 40 °C (-5 ... 104 °F)
- interfaz señal de infrarrojos (diseño exclusivo)
- alimentación eléctrica pila de litio 3 V
- peso 150 g (0,3 lb)
- color negro
- Número de pieza 7ML1930-1BK

¹⁾ Ver *Conexiones eléctricas antideflagrantes* página 9.

²⁾ Ver *Conexiones eléctricas de seguridad aumentada* página 10.

³⁾ Ver *Conexiones eléctricas a prueba de explosiones (FM/CSA EE.UU./Canadá únicamente):* página 10.

⁴⁾ Ver *Conexiones eléctricas no incendiarias (FM/EE.UU. únicamente):* página 11.

⁵⁾ Ver *Conexiones eléctricas de seguridad intrínseca* página 11.

Aplicación bajo presión



- **ADVERTENCIAS:**
- De acuerdo con la Directiva 97 / 23 / CE, este dispositivo se define equipo a presión y no está diseñado para ser utilizado como aparato de seguridad.
- Es imprescindible no destornillar, retirar o desmontar la conexión al proceso o la caja de la electrónica mientras el contenido del tanque esté bajo presión.
- La instalación incorrecta puede provocar una caída de presión del proceso.

Instalación



- **ADVERTENCIAS:**
- Sólo el personal cualificado está autorizado a intervenir en este equipo para la instalación. Observar las indicaciones y los procedimientos de seguridad.
- Los materiales de construcción son seleccionados en base a su compatibilidad química (o inertidad) para usos generales. Antes de instalar el dispositivo en ambientes específicos consulte las tablas de compatibilidad química.

Indicaciones:

- Es recomendable no separar la placa de características del conjunto protegido de la presión¹⁾. Es importante que al efectuar el recambio del aparato se coloque la placa de características en el aparato de recambio.
- Los aparatos SITRANS LR200 se someten a controles de calidad que incluyen la realización de pruebas hidrostáticas. Los resultados cumplen con (o exceden) los requisitos de ASME para calderas y recipientes a presión y la Directiva europea de equipos a presión.

Indicaciones para la instalación

- El aparato debe situarse en un lugar visible, de fácil acceso (programación con el calibrador).
- Montar el aparato tomando en cuenta las características de la caja y los materiales de construcción.
- Prestar atención a que el aparato no esté expuesto al sol, utilizar una pantalla protectora.

¹⁾ El dispositivo incluye piezas no sujetas a la presión en el proceso. Este conjunto de piezas ofrece una barrera efectiva contra pérdidas de presión del tanque. El conjunto combina generalmente la conexión al proceso y el emisor pero no incluye la caja de la electrónica.

Diseño de la boquilla

Indicaciones:

- Para tubos o boquillas de 100 mm (4") máximo utilizar blindaje de 100 m (4").
- Para tubos o boquillas de 250 mm (10") máximo utilizar blindaje de 250 m (10").
- Si desea más detalles, lea por favor el manual completo.

- El extremo de la bocina deberá sobresalir +/- 10 mm (0.4") para evitar interferencias con la boquilla (falsos ecos).

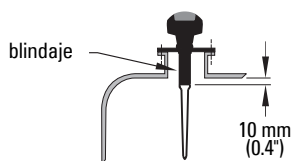

Montaje en la tapa de una boca de hombre

- La tapa de la boca de hombre consiste generalmente en una boquilla cubierta, diámetro mínimo 610 mm (24").
- Para garantizar condiciones ideales para la medida, colocar la antena descentrada con respecto a la tapa de la boca de hombre, generalmente 100 mm (4") de la pared lateral.

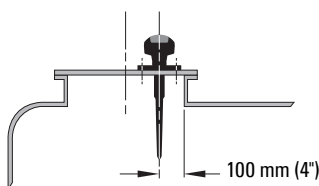

Montaje de la boquilla

! ADVERTENCIA: Es recomendable no instalar el aparato en la parte central de tanques con techo cónico o parabólico. (La concavidad del techo puede dirigir los ecos hacia el centro y dar medidas erróneas.)

Nota: El usuario puede, en determinadas condiciones, instalar el aparato en la parte central de un tanque con techo plano. es recomendable consultar un representante Siemens.

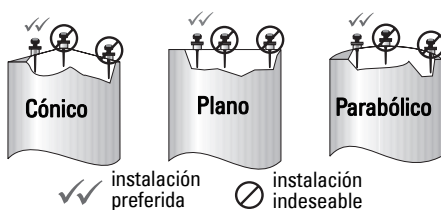

- Mantener el cono de emisión lejos de fuentes de interferencia: peldaños, tubos, vigas en I, o corrientes de llenado.
- Colocar la antena lejos de la pared del tanque. De lo contrario se producen reflexiones parásitas que pueden afectar la medida.
- Proveer el espacio libre suficiente para la propagación del cono de emisión; evitando en lo posible interferencias con las paredes del depósito o con obstrucciones.

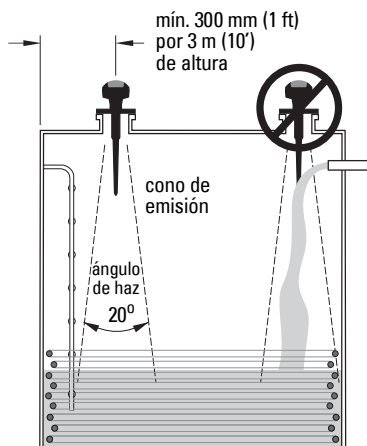

Instrucciones de instalación

Indicaciones:

- El aparato soporta un número ilimitado de rotaciones.
- Dirigir la parte frontal o posterior del aparato a la pared más próxima del tanque.
- No girar la caja del aparato después de la programación y la configuración del aparato (posibilidad de error provocado por el cambio de polaridad del impulso emitido).

Versión roscada

- 1) Se recomienda comprobar que las roscas sean idénticas antes de colocar el aparato en la conexión de montaje (para evitar dañarlas).
- 2) Atornillar el aparato en la conexión al proceso y apretar manualmente. En aplicaciones con presión garantizar la unión hermética de las roscas con una cinta de PTFE u otro sellador. Apriete la conexión de al proceso, máx. torque 40 N·m (30 ft.lbs).
- 3) Para girar la caja, desenroscar los tres tornillos de fijación de la junta. Colocar la caja y volver a apretar los tornillos.



Versión bridada

- ! ADVERTENCIA: El usuario deberá utilizar tornillos y selladores conformes a los límites de la brida y a su utilización, y que se adapten a las condiciones de servicio.**

Conexión eléctrica Alimentación

ADVERTENCIAS:



Para garantizar la conformidad con los requisitos de seguridad (IEC 61010-1), los bornes de conexión (CC) deberían recibir el suministro eléctrico de una fuente que provea el aislamiento eléctrico (entrada/salida).



Todo el cableado en el campo debe contar con el aislamiento adecuado para los voltajes previstos.

Conexión SITRANS LR200



! ADVERTENCIAS:

- Verificar la certificación del aparato en la placa indicadora y en la placa de características.
- Para mantener la protección IP/NEMA asegurar la estanqueidad de los conductos.
- Ver *Instrucciones específicas para instalaciones en entornos peligrosos* página 13.

Indicaciones:

- Para más detalles acerca del cableado, consulte la versión completa del manual de instrucciones.
- Utilizar un cable de par trenzado: AWG 22 - 14 (0,34 mm² - 2,5 mm²).
- Para la instalación eléctrica deben observarse las normas y disposiciones pertinentes. Pueden ser necesarios cables y conductos separados.

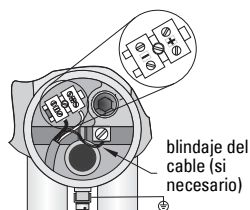
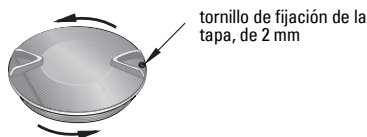

- 1) Aflojar el tornillo de fijación de la tapa con una llave Allen de 2 mm.
- 2) Pelar el extremo de la cubierta del cable unos 70 mm (2,75"), y pasar los cables a través del prensaestopas.
- 3) Conectar los cables con los terminales como se indica: polaridad indicada en los terminales.
- 4) Conectar a la tierra el aparato observando las disposiciones pertinentes.
- 5) Apretar el prensaestopas para un sellado óptimo.
- 6) Cerrar y fijar la junta de unión de la tapa antes de efectuar la programación y la calibración. Nunca gire el aparato después de la calibración. Esto puede causar medidas erróneas.

Conexión HART: configuración típica PLC/mA:

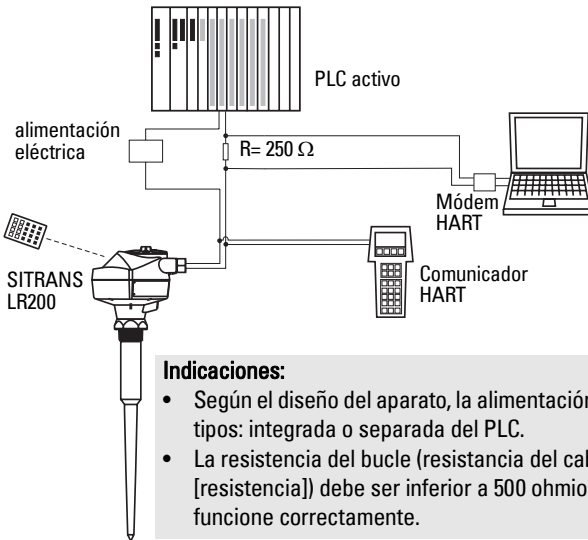

Indicaciones:

- Según el diseño del aparato, la alimentación eléctrica puede ser de dos tipos: integrada o separada del PLC.
- La resistencia del bucle (resistencia del cable + 250 ohmios [resistencia]) debe ser inferior a 500 ohmios para que el aparato funcione correctamente.

Instrucciones para el cableado en zonas potencialmente explosivas

Nota: Los certificados ATEX y los diagramas de conexión indicados a continuación se pueden descargar en nuestra página web: www.siemens.com/LR200.

Existen cinco tipos de cableado para las instalaciones en entornos peligrosos. Verificar la certificación del aparato en la placa indicadora y en la placa de características.

1. Conexiones eléctricas antideflagrantes

SIEMENS			
SITRANS LR200 7ML1234-56789-0A8C-D Serial No: GYZ/S1034567 Encl.: NEMA/TYPE 4X, 6, IP67, IP68 Amb. Temp.: -40°C to 80°C Power Rating: 24V --- Nom., 30V --- Max., 4 - 20mA Siemens Milltronics Process Instruments Inc., Peterborough Made in Canada	⚠	 II 1/2 G EEx dm ia IIC T4 SIRA 05ATEX1001X CE 0682 0518	HART  Um = 250V

Certificación	Zona de validez:	Referencia
ATEX II 1/2 G, EEx dm ia IIC T4	Europa	<i>Flameproof/Increased Safety: ATEX Certificate</i> página A-1.

- Requisitos de alimentación: ver *Curva 2 (Antideflagrante, seguridad aumentada, resistente a explosiones)* página 23.
- Efectuar las conexiones eléctricas observando la normativa local.
- Ver también *Instrucciones específicas para instalaciones en entornos peligrosos* página 13 y el certificado ATEX arriba mencionado.

2. Conexiones eléctricas de seguridad aumentada

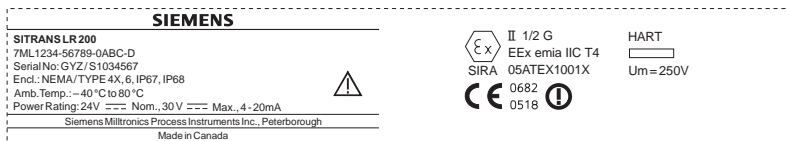

Certificación	Zona de validez:	Referencia
ATEX II 1/2 G, EEx em ia IIC T4	Europa	<i>Flameproof/Increased Safety: ATEX Certificate</i> página A-1.

- Requisitos de alimentación: ver *Curva 2 (Antideflagrante, seguridad aumentada, resistente a explosiones)* página 23.
- Efectuar las conexiones eléctricas observando la normativa local.
- Ver también *Instrucciones específicas para instalaciones en entornos peligrosos* página 13 y el certificado ATEX arriba mencionado.

3. Conexiones eléctricas a prueba de explosiones (FM/CSA EE.UU./Canadá únicamente):

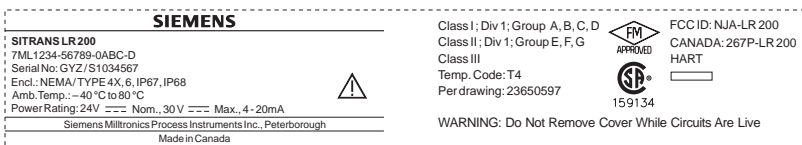

Certificación	Zona de validez:	Referencia
FM/CSA: Clase I, Div. 1, Grupos A, B, C, D Clase II, Div. 1, Grupos E, F, G Clase III T4	EE.UU./ Canadá	Diagrama de conexión FM/CSA a prueba de explosiones, nº 23650597

- Requisitos de alimentación: ver *Curva 2 (Antideflagrante, seguridad aumentada, resistente a explosiones)* página 23.
- Los requisitos de cableado descargables (sólo para Norteamérica) están disponibles en nuestra página web:
www.siemens.com/LR200.

4. Conexiones eléctricas no incendiarias (FM/EE.UU. únicamente):

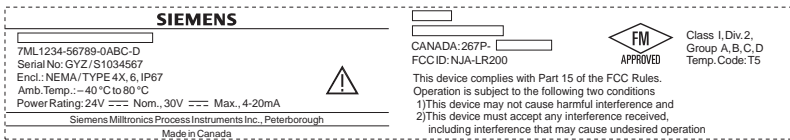

Certificación	Zona de validez:	Referencia
FM: Clase I, Div. 2, Grupos A, B, C, D T5	EE.UU.	Diagrama de conexión FM no incendiario, n° 23650537

- Requisitos de alimentación, ver *Curva 1 (Aplicación general, intrínsecamente segura, sin riesgo de incendio)* página 23.
- Los requisitos de cableado descargables (sólo para Norteamérica) están disponibles en nuestra página web: www.siemens.com/LR200.

5. Conexiones eléctricas de seguridad intrínseca

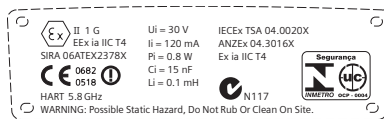
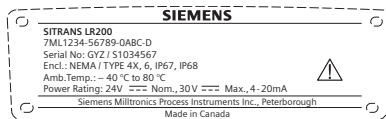
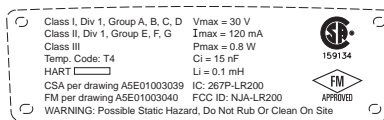
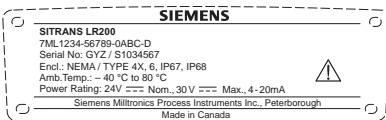

Certificación	Zona de validez:	Referencia
FM/CSA: Clase I, Div. 1, Grupos A, B, C, D Clase II, Div. 1, Grupos E, F, G Clase III	EE.UU./Canadá	Diagrama de conexiones FM seguridad intrínseca, n° A5E01003040 Diagrama de conexiones CSA seguridad intrínseca, n° A5E01003039
ATEX II 1 G, EEx ia IIC T4	Europa	<i>Intrinsically Safe: ATEX Certificate</i> página A-5
ANZEX Ex ia IIC T4 (Tamb = -40 ... 80 °C) IP67	Australia	
IECEX TSA 04.0020X	Internacional	

- Requisitos de alimentación: ver *Curva 1 (Aplicación general, intrínsecamente segura, sin riesgo de incendio)* página 23.

- Requisitos relativos al cableado:
 - Norteamérica: Los certificados ATEX y los diagramas de conexión indicados a continuación se pueden descargar en nuestra página web: www.siemens.com/LR200.
 - Europa: Observe la normativa local.
 - Australia: Observe la normativa local.
 - Internacional: Observe la normativa local.
- Para mantener la protección IP/NEMA asegurar la estanqueidad de los conductos.
- Recomendamos utilizar las barreras de seguridad intrínseca indicadas en *Barreras pasivas, diodo limitador* página 12.
- Ver también *Instrucciones específicas para instalaciones en entornos peligrosos* página 13 y el certificado ATEX arriba mencionado.

Nota: La selección de una tarjeta de entrada PLC, alimentación eléctrica o barrera apropiada requiere conocer la seguridad intrínseca y la aplicación. El instalador es responsable de garantizar la conformidad de la instalación intrínsecamente segura con los requisitos de certificación del dispositivo y los códigos de práctica aplicables.

Barreras pasivas, diodo limitador

Importante: En este caso se requiere tensión de alimentación regulada.

Fabricante	Número de la pieza
MTL	787SP+ (Dos canales)
MTL	7787P+ (Dos canales)
Stahl	9001/01-280-100-10 (Un canal)
Stahl	9002/01-280-110-10 (Dos canales)

Selección de una barrera pasiva para el SITRANS LR200

A continuación se detalla el método para determinar la conformidad de la barrera con los parámetros de entrada intrínsecamente segura del LR200.

- Re-e = máxima resistencia de la barrera (extremo-a-extremo)
- Rloop = resistencia del bucle (resistencia del cable + resistencia de detección, indicadores y/o entradas PLC por ej.)
- Vbarrier = valor de caídas de tensión no lineales provocadas por la barrera

- Determinar el valor Re-e en base a la hoja de datos.
- Calcular el valor total Rloop: adicionando (p.ej.) resistencia de detección, visualización o entradas PLC.
- Calcular Roperación = Re-e + Rlazo.

- 4) Determinar el valor V_{barrier} en base a la hoja de datos de la barrera (p.ej. caídas de tensión provocadas por diodos).
- 5) Calcular $V_{\text{operación}} = V_{\text{alimentación}} - V_{\text{barrera}}$.

Los valores V_{working} y R_{working} permiten confirmar si el aparato funciona respetando los límites indicados en el gráfico (en gris) *Curva 1 (Aplicación general, intrínsecamente segura, sin riesgo de incendio)* página 23.

Indicaciones:

- Esta es sólo una lista parcial: muchas alimentaciones eléctricas y barreras IS disponibles en el mercado ofrecen compatibilidad con el LR200.
- Los módulos de entrada PLC y las barreras a continuación se han comprobado y son funcionalmente compatibles con el LR200.

Barreras activas (barreras repetitivas)

Fabricante	Número de la pieza
MTL	706
MTL	7206
Stahl	9001/51-280-110-14
Pepperl+Fuchs	KSD2-CI-S-Ex
Pepperl+Fuchs	KFD2-STC3-Ex1
MTL	E02009 (verificar)
MTL	E02010

Instrucciones específicas para instalaciones en entornos peligrosos

(Directiva europea ATEX 94/9/CE, Anexo II, 1/0/6)

Las instrucciones se refieren al dispositivo que ha obtenido el certificado número SIRA 06ATEX2378X, SIRA 05ATEX1001X:

- 1) Para más detalles acerca de la utilización y el montaje, véase el manual de instrucciones.
- 2) El equipo eléctrico está clasificado como dispositivo de la categoría 1G.
- 3) El aparato puede ser utilizado en zonas con gases y vapores inflamables, con aparatos del Grupo IIC, IIB y IIA, clases de temperatura T1, T2, T3 y T4.
- 4) El equipo puede soportar temperaturas ambientes de -40 °C a $+80\text{ °C}$.
- 5) El equipo no se ha analizado como sistema de protección, como se indica en la Directiva 94/9/CE Anexo II, cláusula 1.5).
- 6) La instalación e inspección de este equipo eléctrico deberá efectuarse por personal calificado en conformidad con los códigos de práctica aplicables (EN 60079-14 y EN 60079-17 en Europa).

- 7) El aparato no se puede reparar.
- 8) El sufijo 'X' en los números de certificados indica la aplicación de condiciones de seguridad específicas. El personal responsable de la instalación y la verificación del aparato debe tener acceso al contenido de los certificados.
- 9) El usuario es responsable de tomar las precauciones necesarias para evitar el daño del equipo y garantizar el nivel de protección obtenido, si existe la posibilidad de que esté en contacto con productos agresivos.

Ejemplos de productos agresivos: líquidos ácidos o gases que pueden dañar los metales, o disolventes que pueden dañar los polímeros.

Precauciones recomendadas: (p.ej.) confirmación de la resistencia a productos químicos específicos en base a la hoja de datos.

Arranque del SITRANS LR200

Conectar la alimentación eléctrica. El SITRANS LR200 arranca automáticamente en el modo Medida. (Para modificar el idioma utilizado en el display *Selección de una opción (selección de un idioma p.ej.)* página 17.)

Indicador LCD

Modo de medición (funcionamiento normal)

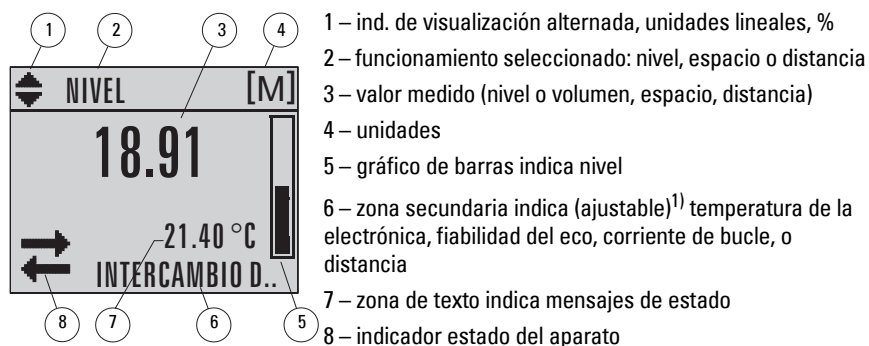

Fallo



S: 0 LOE

- 7 – zona de texto indica código de error y mensaje de error
 8 – indicación del icono que señala la necesidad de mantenimiento

Modo PROGRAM

Navegación

- Si aparece la barra de menú, la lista de menús excede del tamaño del indicador.
- El tamaño del botón de posición aumenta conforme disminuye el número de ítems (menú).

menú actual
 botón de posición
 barra de menús

número de ítem actual
 ítem actual
 apuntador

¹⁾ Pulsando una tecla: ver *Función de las teclas en modo de medición* página 15.

Visualización de parámetros

nombre de parámetro

número de parámetro

valor/
selección de parámetro

Edición

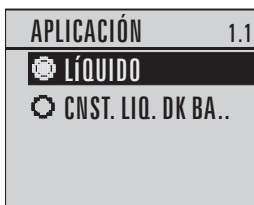

Programador portátil





(Part No. 7ML1930-1BK)

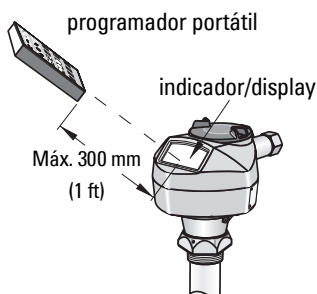



El programador se vende por separado.

- Orientar el programador hacia el indicador (máxima distancia 300 mm [1 ft.])
- Pulsar  para alternar entre los modos Measurement y PROGRAM.



Función de las teclas en modo de medición

Tecla	Función	Resultado
	Mode permite acceder al modo PROGRAM.	Abre el último nivel de menú indicado durante el ciclo de accionamiento actual, o el nivel menú 1 si se ha vuelto a arrancar el aparato después de quitar el modo PROGRAM, o si han transcurrido más de 10 minutos desde la última acción en modo PROGRAM.
	Fecha DERECHA permite acceder al modo PROGRAM.	Abre el nivel menú 1.
 	Fecha ARRIBA o ABAJO alterna la visualización: unidades lineales / %	Indicación (LCD) del valor de medición en unidades lineales o porcentaje.

Tecla	Función	Resultado
	Actualiza la corriente de bucle.	Indica un valor nuevo en la zona secundaria del indicador LCD.
	Actualiza la temperatura interna de la caja.	
	Actualiza el valor de fiabilidad del eco.	
	Actualiza la medida de distancia.	

Programación del SITRANS LR200

Nota: El SITRANS LR200 vuelve automáticamente al modo de medición después un periodo de inactividad en modo PROGRAM (entre 15 segundos y 10 minutos en función del nivel de menú).

La interfaz local permite al usuario modificar los ajustes localmente o remotamente con SIMATIC PDM. La interfaz local (LUI, Local User Interface) se compone de indicador LCD y un programador portátil.

- Ver *Asistente de arranque rápido (vía programador portátil)* página 18.
- Ver *Asistente de Arranque rápido y SIMATIC PDM* página 21.

Menús de parámetros

Nota: Los parámetros están descritos con detalle en la versión completa del manual. La versión completa del manual está disponible en: www.siemens.com/LR200.

Los parámetros se identifican por nombre, se organizan por grupos de función y se distribuyen en un menú con 5 niveles.

1. QUICK START
2. SETUP
3. DIAGNÓSTICO
 - 3.14. VALORES MEDICION
 - 3.14. TEMP. INTERNA ACTUAL

Ajuste de parámetros con el programador portátil

1. Acceder al modo PROGRAM

- a) Orientar el programador hacia el indicador (máx. distancia 300 mm [1 ft]).
- b) Pulsar la **flecha DERECHA**  para acceder al nivel menú 1.

2. Navegación: funciones de las teclas en modo Navegación

Tecla	Nombre	Nivel de menú	Función
	Flecha ARRIBA o ABAJO	menú o parámetro	<ul style="list-style-type: none"> Visualización del menú o parámetro siguiente.
	Flecha DERECHA	menú	<ul style="list-style-type: none"> Acceder al primer parámetro en el menú seleccionado o abrir el menú siguiente.
		parámetro	<ul style="list-style-type: none"> Acceder al modo Edit.
	Flecha IZQUIERDA	menú o parámetro	<ul style="list-style-type: none"> Acceder al menú padre.
	Modo	menú o parámetro	<ul style="list-style-type: none"> Acceder al modo de MEDICIÓN.
	Home	menú o parámetro	<ul style="list-style-type: none"> Acceder al nivel menú 1.

3. Edición en modo PROGRAM

Selección de una opción (selección de un idioma p.ej.)

- Acceder a **Language (Idioma) (7)**.
- Pulsar la **flecha DERECHA** para visualizar el parámetro.
- Pulsar nuevamente la **flecha DERECHA** para acceder al modo **Edición**. Selección del valor actual.

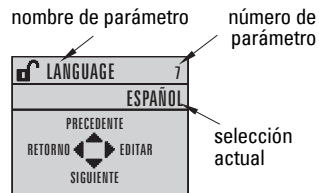

- Acceder a otro valor.

Pulsar la **flecha DERECHA** para confirmar. En el indicador aparecen nuevamente el parámetro y el nuevo valor.





- Pulsar la flecha IZQUIERDA para volver al menú.

Modificación de un valor numérico

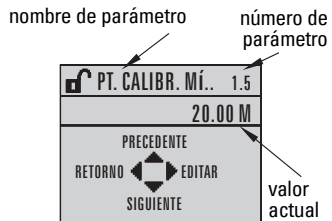
- Acceder al parámetro deseado.
- Pulsar la **flecha DERECHA** para visualizar el parámetro. Indicación del valor actual.







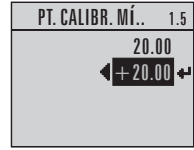



- c) Pulsar nuevamente la **flecha DERECHA**  para acceder al modo **Edición**. Selección del valor actual.
- d) Introducir otro valor, y pulsar la **flecha DERECHA**  para confirmar.

En el indicador aparecen nuevamente el parámetro y el nuevo valor.





Principales funciones, modo Edición





Tecla	Nombre	Función	
 	Flecha ARRIBA o ABAJO	Selección de opciones	<ul style="list-style-type: none"> Accede al ítem.
		Edición numérica	<ul style="list-style-type: none"> Aumenta o disminuye dígitos Alterna entre el signo positivo/negativo
	Flecha DERECHA	Selección de opciones	<ul style="list-style-type: none"> Validación de datos (acceso de escritura/parámetro) Alterna la visualización del modo Edición al modo Navegación
		Edición numérica	<ul style="list-style-type: none"> Mueve el cursor un espacio hacia la derecha o con el cursor colocado en el signo Enter, confirma datos y alterna del modo Edición al modo Navegación
	Flecha IZQUIERDA	Selección de opciones	<ul style="list-style-type: none"> Anula el modo Edición sin modificar el parámetro
		Edición numérica	<ul style="list-style-type: none"> Mueve el cursor hacia el signo positivo/negativo si es la primera tecla pulsada o mueve el cursor un espacio hacia la izquierda.
	Anulación	Edición numérica	<ul style="list-style-type: none"> Borra el display indicador.
	Punto decimal	Edición numérica	<ul style="list-style-type: none"> Introduce un punto decimal.
	Signo +/-	Edición numérica	<ul style="list-style-type: none"> Modifica el signo del valor introducido.
	Numérico	Edición numérica	<ul style="list-style-type: none"> Introduce el carácter correspondiente.

Asistente de arranque rápido (vía programador portátil)

Nota: Cada activación del Asistente provoca la aplicación de los valores predeterminados. El Asistente no aplicará valores definidos previamente por el usuario.

1. Arranque rápido

- a) Orientar el programador hacia el indicador (máx. distancia 300 mm [1 ft.]), y pulsar la **flecha DERECHA**  para activar el modo PROGRAM y acceder al menú, nivel 1.
- b) Pulsar dos veces la **flecha DERECHA**  para acceder al ítem menú 1.1 y visualizar parámetros.

- c) Pulsar la **flecha DERECHA**  para acceder al modo **Edición** ó la **flecha ABAJO**  para aceptar valores predefinidos y acceder directamente al ítem siguiente.
- d) Los valores se modifican accediendo a un ítem o introduciendo un nuevo valor.
- e) Después de modificar un valor pulsar la **flecha DERECHA**  para confirmar y la **flecha ABAJO**  para acceder al ítem siguiente.
- f) Los ajustes realizados durante el Arranque Rápido sólo se implementan seleccionando **Yes (Sí)** en respuesta a **Apply changes (Aplicar modificaciones)** en la etapa 1.7.

1.1. Material

Opciones	LIQUID(0)
	LIQUID LOW DK (líquido con bajo dieléctrico)

1.2. Velocidad de reacción

Velocidad de reacción del aparato a variaciones en la medida (rango principal).

Opciones	LENTO	0,1 m/minuto
	MEDIO	1,0 m/minuto
	RAPIDO	10,0 m/minuto

Seleccionar una velocidad de reacción ligeramente más rápida que la máxima velocidad de llenado/vaciado (valor más alto).

1.3. Unidades sensor

Selecciona las unidades aplicables a las variables del Arranque rápido (punto superior/inferior de calibración, nivel, distancia, espacio).

Opciones	M, CM, MM, FT, IN
-----------------	-------------------

1.4. Funcionamiento

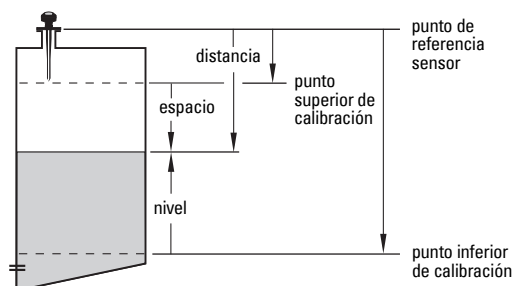

Tipos de funcionamiento	NO SERVICE	(INTERRUPCION DE SERVICIO) El SITRANS LR200 deja de actualizar las medidas y la corriente de bucle asociada. El aparato indica la última medida válida.
	NIVEL	Distancia a la superficie del material referenciada al punto inferior de calibración (nivel proceso vacío).
	ESPACIO	Distancia a la superficie del material referenciada al punto superior de calibración (nivel proceso lleno).
	DISTANCIA	Distancia a la superficie del material referenciada al punto de referencia del sensor.

1.5. Punto inferior de calibración

Distancia desde el punto de referencia sensor al punto inferior de calibración: generalmente el nivel proceso vacío.

Valores	Rango: 0,0000 ... 20,000 m
----------------	----------------------------

1.6. Punto superior de calibración

Distancia del punto de referencia sensor al punto superior de calibración: generalmente el nivel proceso lleno.

Valores	Rango: 0,0000 ... 20,000 m
----------------	----------------------------

1.7. Apply? (¿Aplicar modificaciones ?)





Los ajustes realizados durante el Arranque Rápido sólo se implementan seleccionando **Sí**.

Opciones	SI, NO
-----------------	--------

Indicación de **DONE** al final del Arranque Rápido.

Pulsar **Mode**  para volver al modo de medida. El SITRANS LR200 está listo para funcionar.

Obtención de un perfil de eco

- 1) En modo PROGRAM, visualizar: **Medidor de nivel > Diagnóstico (3) > Perfil de eco (3.1)**.
- 2) Pulsar la **flecha DERECHA**  para obtener un perfil.
- 3) En el campo Perfil, pulsar la **flecha ARRIBA**  para seleccionar el icono **Transmisión**, y la **flecha DERECHA**  para actualizar el perfil.
- 4) Pulsar la **flecha ABAJO**  para seleccionar el icono **Exit (Salir)** y la **flecha DERECHA**  para volver al menú precedente.

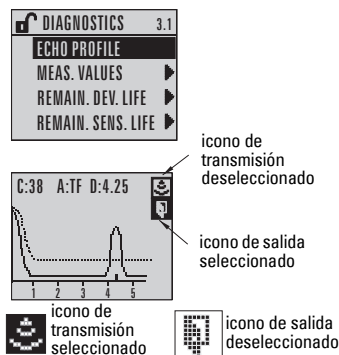

Comunicación SITRANS LR200: HART

- Para más detalles acerca de todos los parámetros accesibles ver la versión completa del manual de instrucciones.
- Recomendamos parametrizar el aparato utilizando el software SIMATIC Process Device Manager (PDM).

SIMATIC PDM

Indicaciones:

- Recomendamos utilizar SIMATIC PDM Rev 6.0 SP3 o una versión ulterior.
- SIMATIC PDM Rev. 5.2 SP1 sólo se utiliza para las funciones básicas de configuración y diagnóstico. Las funciones avanzadas como el Asistente de arranque rápido requieren la versión 6.0 SP3 (o ulterior).

SIMATIC PDM es una herramienta universal destinada a poner en servicio y mantener los aparatos SITRANS LR200 y otros instrumentos de proceso. Para más detalles, consulte las instrucciones de uso del SIMATIC PDM o la ayuda en línea. (Para más detalles ver www.siemens.com/simatic-pdm. Consulte **Products and Solutions > Products and Systems > Communications and Software > Process Device Manager.**)

Electronic Device Description (EDD)

- El fichero EDD está disponible en el Catálogo de aparatos (Device Catalog) en **Sensors/Level/ Echo/Siemens Milltronics/SITRANS LR200**.
- Consultar la página Producto en nuestra web: www.siemens.com/LR200, bajo **Downloads**, para obtener la última versión de SIMATIC PDM, y los más recientes SP y HF (hot fix). Para instalar un nuevo fichero EDD ver *Configuración de un nuevo aparato* a continuación.

Configuración de un nuevo aparato

Nota: La selección de **Cancel/Anular** durante una actualización instrumento/SIMATIC PDM provoca la actualización de ciertos parámetros.

1. Comprobar la versión del fichero EDD instalado, y descargar un fichero más reciente si es necesario (página Producto indicada arriba). Guardar los datos en el PC y extraer el fichero zip, dejándolo fácilmente accesible. Lanzar **SIMATIC PDM – Manager Device Catalog**, seleccionar el fichero EDD no comprimido.
2. Lanzar SIMATIC PDM y crear un proyecto nuevo para el LR200. Las guías de aplicación para la configuración de aparatos HART con SIMATIC PDM están disponibles en la página Producto de nuestro sitio web: www.siemens.com/LR200.
3. Telecargar los parámetros en el PC/PG.
4. Configurar el aparato con el Asistente de Arranque rápido (ver abajo).

Asistente de Arranque rápido y SIMATIC PDM

Indicaciones:

- Los ajustes del Asistente de Arranque rápido están interrelacionados. Para aplicar modificaciones, hacer clic en **Transfer/Transferir** al final de la etapa 5.
- Cada activación del Asistente provoca la aplicación de los valores predeterminados. El Asistente no aplicará valores definidos previamente por el usuario.
- Hacer clic en **BACK (PRECEDENTE)** para volver y corregir un valor o **Cancel (Anular)** para salir del arranque rápido.

Lanzar el programa SIMATIC PDM, abrir el menú **Device – Quick Start**, y seguir las etapas 1 - 5.

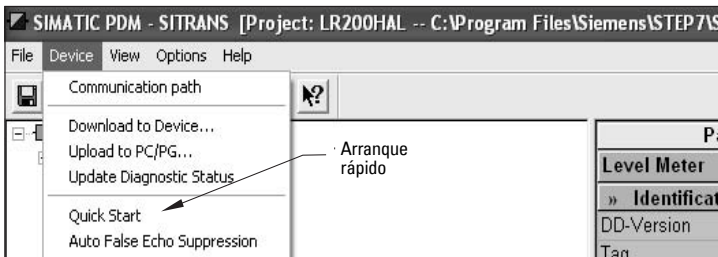

Mantenimiento

Al funcionar en condiciones normales el SITRANS LR200 no necesita mantenimiento o limpieza. Sin embargo, en condiciones de operación difíciles se recomienda:

1. Seleccionar un producto de limpieza apto para la antena y el material en el proceso controlado.
2. Retirar el aparato del depósito y limpiar la antena con un paño y un producto adecuado.

Reparaciones y límite de responsabilidad

Para más detalles ver la última página de este documento.

Temperaturas máximas de proceso

! ADVERTENCIA: La temperatura interna no debe sobrepasar 80 °C (176 °F).

Máxima temperatura brida y proceso / Temperatura ambiente admisible para SITRANS LR200 con adaptador de brida

- El gráfico es de carácter informativo.
- Este gráfico no presenta todas las posibilidades de conexión al proceso. NO se aplica p.ej. colocando el SITRANS LR200 en una superficie metálica del tanque/depósito.
- No toma en cuenta el aumento de temperatura ocasionado por la exposición directa al sol.
- El parámetro 3.14.1 permite monitorizar la temperatura interna actual.

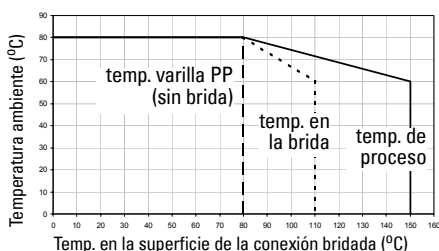

Bucle de alimentación

Diagrama de conexión típico

Nota: La tensión de bucle corresponde a la tensión presente en los bornes de alimentación (no la tensión en los bornes del aparato).

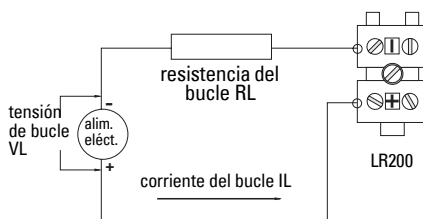

Zona de funcionamiento autorizada

Curva 1 (Aplicación general, intrínsecamente segura, sin riesgo de incendio)

Tensión / resistencia de lazo

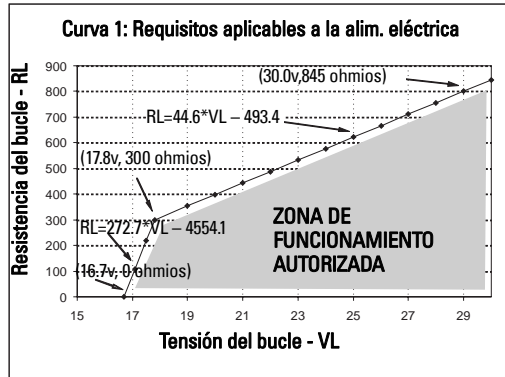

Curva 2 (Antideflagrante, seguridad aumentada, resistente a explosiones)

Tensión/resistencia de lazo

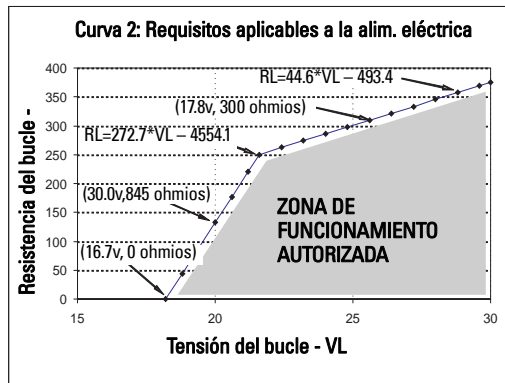

Curva de arranque

Nota: El aparato puede necesitar entre 25 y 55 segundos durante el arranque para proporcionar la medida de nivel.

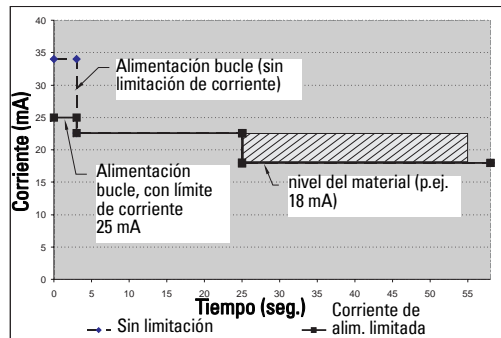

Notas

Mise en service rapide SITRANS LR200 (HART) avec interface LUI Siemens

Ce manuel décrit les caractéristiques et les fonctions essentielles du SITRANS LR200 (HART). Il est fortement recommandé de se reporter à la version complète du manuel d'utilisation pour accéder à l'ensemble des fonctions. La version complète du manuel est disponible sur la page produit SITRANS LR260, sur le site : www.siemens.com/LR200. Pour obtenir une version imprimée de la documentation, contactez votre représentant Siemens Milltronics.

Toute question sur le contenu de ce document peut être adressée à :

Siemens Milltronics Process Instruments Inc.
1954 Technology Drive, P.O. Box 4225
Peterborough, Ontario, Canada, K9J 7B1
e-mail : techpubs.smpi@siemens.com

**Copyright Siemens Milltronics
Process Instruments Inc. 2008.
Tous droits réservés**

Clause de non-responsabilité

Nous encourageons les utilisateurs à se procurer les exemplaires imprimés de ces manuels ou les versions électroniques préparées et validées par Siemens Milltronics Process Instruments Inc. Siemens Milltronics Process Instruments Inc. ne pourra être tenu responsable du contenu de toute reproduction totale ou partielle des versions imprimées ou électroniques.

Les informations fournies dans ce manuel ont été vérifiées pour garantir la conformité avec les caractéristiques du système. Des divergences étant possibles, nous ne pouvons en aucun cas garantir la conformité totale. Ce document est révisé et actualisé régulièrement pour inclure les nouvelles caractéristiques. N'hésitez pas à nous faire part de vos commentaires.

Sous réserve de modifications techniques.

MILLTRONICS est une marque déposée de Siemens Milltronics Process Instruments Inc.

Assistance technique

L'assistance technique est disponible 24h/24.

Vous trouverez les coordonnées de l'interlocuteur Siemens Automatisation le plus proche à l'adresse :

www.siemens.com/automation/partner :

- Sélectionnez d'abord la langue d'affichage (français). Cliquez sur l'onglet **Partenaire(s) par produits** et cherchez la branche souhaitée (**+Automatisation de processus > +Instrumentation de processus > +Appareils de mesure de niveau**).
- Sélectionnez ensuite le domaine **Support technique**. Cliquez sur **Suite**.
- Cliquez sur un continent, un pays, une ville. Cliquez sur **Suite**.

Vous trouverez l'assistance technique en ligne à l'adresse : www.siemens.com/automation/support-request

- Indiquez le nom du produit (SITRANS LR200) ou le numéro de commande et cliquez sur **Rechercher**, puis sélectionnez le type de produit. Cliquez sur **Suite**.
- Entrez un mot clé pour la requête. Accédez à la documentation souhaitée en ligne ou cliquez sur **Suivant** pour écrire aux spécialistes de l'Assistance Technique Siemens.

Centre d'assistance technique Siemens A&D : Tél. +49 180 50 50 222
Fax +49 180 50 50 223

Consignes de sécurité

Il est important de respecter les consignes fournies dans ce manuel d'utilisation afin de garantir la sécurité de l'utilisateur ou de tiers et la protection de l'appareil ou de tout équipement connecté à ce dernier. Chaque avertissement s'associe à une explication détaillée du niveau de précaution recommandé pour chaque opération.



AVERTISSEMENT : fait référence à une mention sur le produit. Signifie que la mort, des blessures corporelles graves et/ou des dommages matériels conséquents peuvent se produire si les dispositions de sécurité correspondantes ne sont pas respectées.



AVERTISSEMENT ¹⁾: signifie que la mort, des blessures corporelles graves et/ou des dommages matériels conséquents peuvent se produire si les dispositions de sécurité correspondantes ne sont pas respectées.

Remarque : information importante concernant le produit ou une section particulière de la notice d'utilisation.

Conformité FCC

U.S.A. uniquement : Règles FCC (Federal Communications Commission)



AVERTISSEMENT : Les changements ou les modifications effectués sans l'accord préalable de Siemens Milltronics peuvent remettre en cause les droits d'utilisation de l'équipement.

N.B. :

- Cet équipement est conforme aux limites imposées (alinéa 15 de la réglementation FCC, Classe A). Cette réglementation vise à assurer une protection suffisante contre les interférences nocives lorsque l'équipement est utilisé dans un environnement commercial.
- Cet équipement génère, utilise et peut émettre de l'énergie fréquence radio. Pour cette raison, il doit être installé et utilisé suivant les instructions fournies, pour éviter toute interférence nocive aux communications radio. L'utilisation de cet équipement dans une zone résidentielle peut provoquer des interférences nocives. Il appartiendra à l'utilisateur de prendre en charge les conséquences de ces dysfonctionnements.

SITRANS LR200



AVERTISSEMENT : Pour garantir la sécurité, le SITRANS LR200 doit être utilisé suivant les consignes fournies dans ce manuel d'utilisation.

N.B. : Cet instrument est conçu pour une utilisation en milieu industriel. Utilisé en zone résidentielle, cet appareil peut provoquer des perturbations des communications radio.

Le SITRANS LR200 est un radar à impulsions 6 GHz, technologie 2 fils pour la mesure en continu de liquides et de boues liquides dans les cuves de stockage présentant pression et températures élevées. Plages jusqu'à 20 m (66ft).

¹⁾ Ce symbole est utilisé lorsque le produit ne comporte pas de marquage de sécurité.

Cet instrument se compose d'une électronique associée à une antenne conique et à un raccord process (filetage ou bride).

Communication HART¹⁾. Le logiciel Process Intelligence assure le traitement des signaux.

Caractéristiques Techniques

Pour une liste exhaustive se reporter au manuel d'utilisation SITRANS LR200 (HART). Les homologations sont indiquées sur la plaque signalétique et sur l'étiquette du produit.

Température ambiante/de fonctionnement

Remarques :

- La température et la pression de process applicables varient en fonction des informations reportées sur l'étiquette du produit. Le schéma de référence indiqué sur la plaque signalétique se trouve à l'adresse : www.siemens.com/LR200.
- La température maximale varie en fonction du raccord process, du type d'antenne et de la pression dans la cuve. Pour plus de détails se reporter à *Température de process maximum* page 22. Les courbes de limitation Pression/Température de process sont fournies dans la version complète du manuel d'utilisation.

température ambiante (volume autour du boîtier)

-40 °C ... +80 °C (-40 °F ... +176 °F)

température de process

tige en PP :

-40 °C ... +80 °C (-40 °F ... +176 °F)

tige en PTFE ou cône en acier inox. :

-40 °C ... +200 °C (-40 °F ... +392 °F)

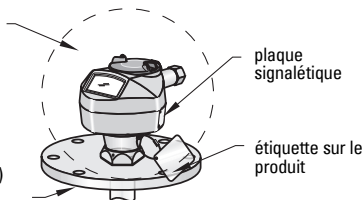

Alimentation



Usage général :

Non-incendiaire (FM/USA uniquement) :

Sécurité intrinsèque :

Nominale 24 V CC, max.
résistance de la
boucle 550 Ohm.



Enveloppe antidéflagrante :

Sécurité augmentée :

Antidéflagrant (FM/CSA USA/Canada uniquement) :

Nominale 24 V CC, max.
résistance de la
boucle 250 Ohm.

Homologations

- Usage général CSA_{US/C}, FM, CE
- Radio Europe (R&TTE), FCC, Industry Canada

(cf. page suivante)

1) HART[®] est une marque déposée de HART Communication Foundation.

- Zone dangereuse
Antidéflagrant (Europe)¹⁾ ATEX II 1/2 G, EEx dm ia IIC T4
Sécurité augmentée (Europe)²⁾ ATEX II 1/2 G, EEx em ia IIC T4
Protection contre les explosions (USA, Canada)³⁾ FM/CSA : (barrière non requise)
Classe I, Div. 1, Gr. A, B, C, D
Classe II, Div 1, Gr. E, F & G
Classe III T4

N.B. : Pour garantir la protection IP/NEMA veiller à l'étanchéité des conduits.

Homologations (suite)

- Zone dangereuse
 - Non-incendiaire (USA)⁴⁾ FM : (barrière non requise)
Classe I, Div. 2, Groupes A, B, C, D, T5
 - Sécurité intrinsèque⁵⁾
(Europe) ATEX II 1 G, EEx ia IIC T4
(USA/Canada) FM/CSA : (barrière requise)
Classe I, Div. 1, Gr. A, B, C, D
Classe II, Div 1, Gr. E, F & G
Classe III T4
 - (Australie) ANZEX Ex ia IIC T4
(Tamb = -40 ... +80 °C) IP67
 - (International) IECEx TSA 04.0020X T4
- Marine Lloyd's Register of Shipping
Certification ABS (American Bureau of Shipping)

Programmateur (clavier infrarouge)

Programmateur portatif SI (de sécurité intrinsèque) Siemens Milltronics pour zones dangereuses et exploitations générales (batterie non remplaçable, durée de vie normale de 10 ans en conditions normales de fonctionnement)

- Agrément ATEX II 1 G, EEx ia IIC T4, certificat SIRA 01ATEX2147
- FM/CSA : Classe I, Div. 1, Groupes A, B, C, D
- Température ambiante -20 ... 40 °C (-5 ... 104 °F)
- Interface signal infrarouge exclusif
- Alimentation pile lithium 3 V
- Poids 150 g (0,3 lb)
- Couleur noir
- Référence 7ML1930-1BK

¹⁾ Se reporter à *Sécurité antidéflagrante* page 9.

²⁾ Se reporter à *Sécurité augmentée* page 10.

³⁾ Se reporter à *Antidéflagrant (FM/CSA, USA/Canada uniquement)* page 10.

⁴⁾ Se reporter à *Non-incendiaire (FM/USA uniquement)* page 11.

⁵⁾ Se reporter à *Sécurité intrinsèque* page 11.

Applications avec pression



- **AVERTISSEMENTS :**
- Conformément à la Directive 97/23/CE, cet appareil est un accessoire sous pression et ne doit pas être utilisé en tant qu'instrument de sécurité.
- Ne jamais dévisser, retirer ou démonter le raccord process ou le boîtier de l'appareil lorsque l'intérieur de la cuve est sous pression.
- Une installation incorrecte peut provoquer une chute de pression dans le process.

Installation



- **AVERTISSEMENTS :**
- L'installation doit être effectuée par un personnel qualifié, en accord avec les dispositions locales en vigueur.
- Cet appareil est conçu avec des matériaux choisis en fonction de leur compatibilité chimique, pour une exploitation générale. Se reporter aux tableaux de compatibilité avant toute utilisation dans un environnement spécifique.

N.B. :

- Ne pas dissocier l'étiquette de l'appareil de l'ensemble non exposé à la pression de process¹⁾. Lorsque l'enveloppe de protection de l'appareil est remplacée, veiller à attacher l'étiquette à l'unité de remplacement.
- Les instruments SITRANS LR200 sont soumis à des tests hydrostatiques, et présentent des résultats conformes ou supérieurs aux exigences établies par le Code ASME (chaudière et pression cuve) et par la Directive européenne concernant les appareils à pression.

Consignes pour l'installation

- Assurer l'accès facile à l'afficheur et à la programmation avec le programmeur portatif.
- Choisir un environnement adapté à l'indice de protection du boîtier et aux matériaux de construction.
- Prévoir une protection spéciale lorsque l'instrument est exposé au soleil.

¹⁾ L'appareil comporte un ensemble de pièces non exposées à la pression du process. Cet ensemble sert de barrière contre une éventuelle perte de pression dans la cuve. Il associe le corps du raccord process et l'émetteur mais exclut généralement le boîtier de l'électronique.

Type de piquage

Remarques :

- Pour les réhausses de jusqu'à 100 mm (4") de longueur prévoir une protection de 100 mm (4").
- Pour les réhausses de jusqu'à 250 mm (10") de longueur prévoir une protection de 250 mm (10").
- D'autres exemples d'application sont décrits dans la version complète du manuel.

- Extrémité de la protection/blindage doit dépasser de 10 mm (0.4") minimum pour éviter toute interférence (échos parasites).

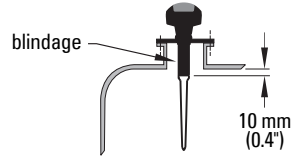

Montage sur couvercle de trou d'homme

- Un trou d'homme avec couvercle correspond généralement à une rehausse couverte, dont le diamètre minimum est de 610 mm (24").
- Pour obtenir les meilleurs résultats de mesure, l'antenne doit être légèrement décalée par rapport au centre, soit à 100 mm (4") de la section latérale.

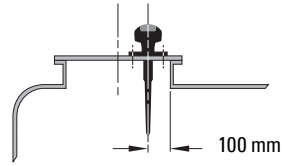

Positionnement du piquage

! AVERTISSEMENT : Ne pas installer l'appareil au dessus de la partie centrale des cuves équipées d'un toit conique ou parabolique. (La concavité du toit peut orienter les échos vers la partie centrale de la cuve et engendrer des lectures erronées.)

N.B. : Dans certains cas l'appareil de mesure peut être installé sur la partie centrale des cuves équipées d'un toit plat. Pour cela, veuillez prendre contact avec votre représentant Siemens.

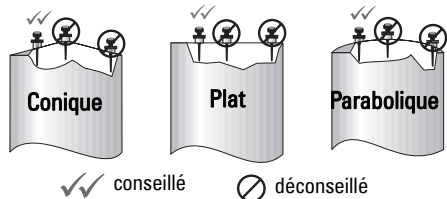

- Eviter toute interférence avec le faisceau d'émission (échelles, tuyaux, poutrelles, ou points de remplissage.)
- Installer l'antenne loin des parois de la cuve, pour éviter toute interférence avec les échos parasites.
- Prévoir le dégagement nécessaire pour la propagation du faisceau, permettant d'éviter toute interférence avec les parois de la cuve ou les obstructions.

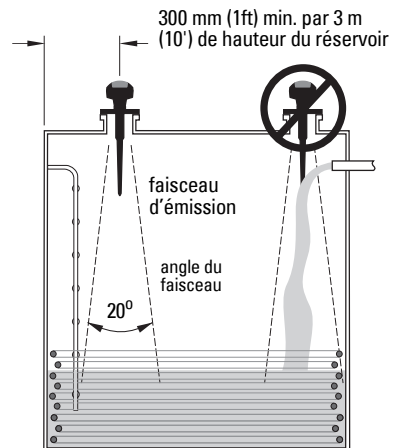

Consignes pour l'installation

Remarques :

- La rotation de l'appareil s'effectue sans limites, selon les besoins de l'utilisateur.
- Orienter la partie frontale ou la section arrière de l'appareil vers la paroi la plus proche.
- Ne pas tourner le boîtier après la programmation et la configuration de l'appareil. Ceci peut entraîner des erreurs associées à l'inversion de polarité de l'impulsion transmise.

Version fileté

- 1) Avant de visser l'appareil sur le raccord de montage, vérifier que les filetages soient identiques pour éviter de les endommager.
- 2) Visser l'appareil sur le raccord process. Un serrage manuel suffit. Lorsque l'appareil est utilisé dans des cuves sous pression, appliquer un ruban PTFE (ou un produit d'étanchéité équivalent) sur le filetage et serrer davantage le raccord process (couple de serrage max. 40 N-m (30 ft.lbs)).
- 3) Pour tourner le boîtier, dévisser d'abord les vis de fixation du joint de serrage. Une fois l'orientation souhaitée obtenue, resserrer les vis.

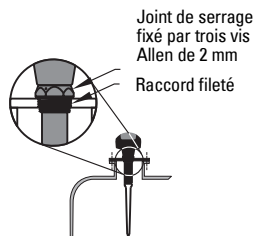

Version avec bride

! **AVERTISSEMENT : Le boulonnage et les joints choisis par l'utilisateur doivent permettre de respecter les consignes et les limites d'utilisation de la bride, et s'adapter aux conditions de fonctionnement.**

Câblage Alimentation électrique

AVERTISSEMENTS :



Les bornes d'entrée CC doivent être alimentées par une source à même de fournir l'isolation électrique entrée/sortie requise pour la conformité avec les règles de sécurité de la norme IEC 61010-1.



Isoler tous les câblages en tenant compte des tensions nominales.

Raccordement du SITRANS LR200



AVERTISSEMENTS :

- Vérifier les homologations indiquées sur la plaque signalétique et l'étiquette de l'appareil.
- Pour garantir la protection IP/NEMA veiller à l'étanchéité des conduits.
- Consulter *Instructions spécifiques pour l'installation en zone dangereuse* page 13.

N.B. :

- Pour plus de détails sur les raccordements électriques, consulter le manuel d'utilisation complet.
- Utiliser un câble paire torsadée : AWG 22 - 14 (0,34 mm² - 2,5 mm²).
- Des câbles et des conduits séparés peuvent être nécessaires pour garantir la conformité avec les consignes de câblage ou les normes électriques.

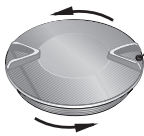

Verrouillage capot : vis de pression 2 mm.

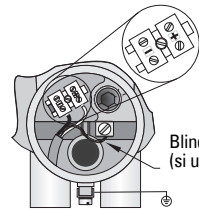

- 1) Utiliser une clé Allen de 2 mm pour dévisser la vis de serrage, puis dévisser le capot de l'appareil.
- 2) Retirer environ 70 mm (2.75") de gaine à l'extrémité du câble. Faire passer les câbles à travers le presse-étoupe.
- 3) Connecter les câbles au bornier tel qu'illustré. La polarité est indiquée sur le bornier.
- 4) Effectuer la mise à la terre suivant les prescriptions locales.
- 5) Serrer le presse-étoupe pour garantir l'étanchéité.
- 6) Fermer le capot et serrer le joint de serrage avant la programmation et l'étalonnage de l'appareil. La rotation de l'appareil après la configuration peut générer des erreurs.

Connexion HART : Configuration type API/mA

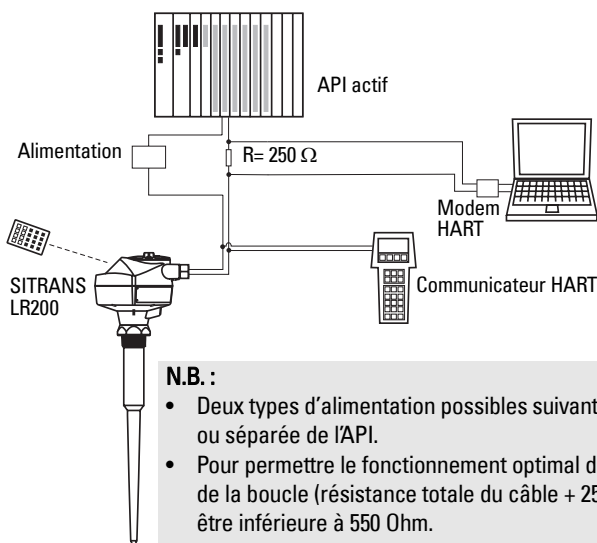

Instructions relatives au câblage pour zones dangereuses

N.B. : Les certificats ATEX et les schémas de câblage indiqués ci-dessous sont disponibles sur notre site web : www.siemens.com/LR200.

Il existe cinq possibilités de câblage pour l'installation en zone dangereuse. Dans tous les cas il est impératif de vérifier les homologations indiquées sur la plaque signalétique et l'étiquette de l'appareil.



1. Sécurité antidéflagrante

SIEMENS			
SITRANS LR200 7ML1234-56789-0ABC-D Serial No: GYZ/S1034567 Encl.: NEMA/TYPE 4X, 6, IP67, IP68 Amb. Temp.: -40°C to 80°C Power Rating: 24V ~~~ Nom., 30V ~~~ Max., 4 - 20mA	⚠	II 1/2 G EEx dmia IIC T4 SIRA 05ATEX1001X 0682 051B	HART Um = 250V
<small>Siemens Milltronics Process Instruments Inc., Peterborough Made in Canada</small>			

Conformité	Zone de validité	Référence
ATEX II 1/2 G, EEx dm ia IIC T4	Europe	<i>Flameproof/Increased Safety: ATEX Certificate page A-1.</i>

- Pour plus de détails sur la consommation de courant, voir *Courbe 2 (Enveloppe antidéflagrante, sécurité augmentée, protection contre les explosions)* page 23.
- Effectuer le câblage selon les dispositions réglementaires locales.
- Consulter *Instructions spécifiques pour l'installation en zone dangereuse* page 13 ainsi que le certificat ATEX indiqué ci-dessus.



2. Sécurité augmentée

SIEMENS			
SITRANS LR200		 II 1/2 G EEx emia IIC T4 SIRA 05ATEX1001X 0682 0518	HART <input type="checkbox"/>
7ML1234-56789-0ABC-D			Um = 250V
Serial No: GYZ/S1034567			
Encl.: NEMA/TYPÉ 4X, 6, IP67, IP68			
Amb. Temp.: -40°C to 80°C			
Power Rating: 24V --- Nom. 30V --- Max. 4-20mA			
Siemens Milltronics Process Instruments Inc., Peterborough Made in Canada			

Conformité	Zone de validité	Référence
ATEX II 1/2 G, EEx em ia IIC T4	Europe	<i>Flameproof/Increased Safety: ATEX Certificate page A-1.</i>

- Pour plus de détails sur la consommation de courant, voir *Courbe 2 (Enveloppe antidéflagrante, sécurité augmentée, protection contre les explosions)* page 23.
- Effectuer le câblage selon les dispositions réglementaires locales.
- Consulter *Instructions spécifiques pour l'installation en zone dangereuse* page 13 ainsi que le certificat ATEX indiqué ci-dessus.

3. Antidéflagrant (FM/CSA, USA/Canada uniquement)

SIEMENS			
SITRANS LR200		 Class I; Div 1; Group A, B, C, D Class II; Div 1; Group E, F, G Class III Temp. Code: T4 Per drawing: 23650597	FCC ID: NJA-LR 200
7ML1234-56789-0ABC-D			CANADA: 267P-LR 200
Serial No: GYZ/S1034567			HART <input type="checkbox"/>
Encl.: NEMA/TYPÉ 4X, 6, IP67, IP68			
Amb. Temp.: -40°C to 80°C			
Power Rating: 24V --- Nom. 30V --- Max. 4-20mA			159134
Siemens Milltronics Process Instruments Inc., Peterborough Made in Canada			
WARNING: Do Not Remove Cover While Circuits Are Live			

Conformité	Zone de validité	Référence
FM/CSA : Classe I, Div. 1, Groupes A, B, C, D Classe II, Div. 1, Groupes E, F, G Class IIIT4	USA/Canada	Schéma de raccordement pour protection antidéflagrante (FM/CSA), réf. 23650597

- Pour plus de détails sur la consommation de courant, voir *Courbe 2 (Enveloppe antidéflagrante, sécurité augmentée, protection contre les explosions)* page 23.
- Les dispositions réglementaires applicables aux câblage (Amérique du Nord uniquement) sont indiquées dans le schéma de raccordement ci-dessus, disponible sur la page produit de notre site web : www.siemens.com/LR200.





4. Non-incendiaire (FM/USA uniquement)

SIEMENS	CANADA: 267P- FCC ID: NJA-LR200	 APPROVED	Class I, Div. 2, Group A, B, C, D Temp. Code: T5
7ML1234-56789-0ABC-D Serial No: GYZ / S1034567 Encl.: NEMA / TYPE 4X, 6, IP67 Amb. Temp.: -40 °C to 80 °C Power Rating: 24V --- Nom., 30V --- Max., 4-20mA Siemens Milltronics Process Instruments Inc., Peterborough Made in Canada			
			This device complies with Part 15 of the FCC Rules. Operation is subject to the following two conditions 1) This device may not cause harmful interference and 2) This device must accept any interference received, including interference that may cause undesired operation

Conformité	Zone de validité	Référence
FM : Classe I, Div. 2, Groupes A, B, C, D, T5	USA	Schéma de raccordement protection non-incendiaire (FM), réf. 23650537

- Pour plus de détails sur la consommation électrique, consulter *Courbe 1 (Usage général, sécurité intrinsèque, protection non-incendiaire)* page 23.
- Les dispositions réglementaires applicables aux câblage (Amérique du Nord uniquement) sont indiquées dans le schéma de raccordement ci-dessus, disponible sur la page produit de notre site web : www.siemens.com/LR200.

5. Sécurité intrinsèque

SIEMENS	Class I, Div 1, Group A, B, C, D Class II, Div 1, Group E, F, G Class III Temp. Code: T4 HART CSA per drawing A5E01003039 FM per drawing A5E01003040 WARNING: Possible Static Hazard, Do Not Rub Or Clean On Site		Vmax = 30 V Imax = 120 mA Pmax = 0.9 W Ci = 15 nF Li = 0.1 mH 159134  APPROVED
SITRANS LR200 7ML1234-56789-0ABC-D Serial No: GYZ / S1034567 Encl.: NEMA / TYPE 4X, 6, IP67, IP68 Amb. Temp.: -40 °C to 80 °C Power Rating: 24V --- Nom., 30V --- Max., 4-20mA Siemens Milltronics Process Instruments Inc., Peterborough Made in Canada			
SIEMENS	II 1 G EEx ia IIC T4 SIRA 06ATEX2378X CE 0682 0916 HART 5.8 GHz WARNING: Possible Static Hazard, Do Not Rub Or Clean On Site.		IECEX TSA 04.0020X ANZEx 04.3016X Ex ia IIC T4 Security N117 
SITRANS LR200 7ML1234-56789-0ABC-D Serial No: GYZ / S1034567 Encl.: NEMA / TYPE 4X, 6, IP67, IP68 Amb. Temp.: -40 °C to 80 °C Power Rating: 24V --- Nom., 30V --- Max., 4-20mA Siemens Milltronics Process Instruments Inc., Peterborough Made in Canada			

Conformité	Zone de validité	Référence
FM / CSA : Classe I, Div. 1, Groupes A, B, C, D Classe II, Div 1, Gr. E, F & G Classe III	USA / Canada	Schéma de raccordement protection sécurité intrinsèque (FM), réf. A5E01003040 Schéma de raccordement protection sécurité intrinsèque (CSA), réf. A5E01003039
ATEX II 1 G, EEx ia IIC T4	Europe	<i>Intrinsically Safe: ATEX Certificate</i> page A-5
ANZEX Ex ia IIC T4 (Tamb = -40 ... 80 °C) IP67	Australie	
IECEX TSA 04.0020X	International	

- Pour plus de détails sur la consommation de courant, voir *Courbe 1 (Usage général, sécurité intrinsèque, protection non-incendiaire)* page 23.

- Exigences relatives au câblage :
 - Amérique du Nord : Consulter les schémas de raccordement indiqués ci-dessus, disponibles sur la page produit de notre site web : www.siemens.com/LR200.
 - Europe : Respecter les dispositions réglementaires locales.
 - Australie : Respecter les dispositions réglementaires locales.
 - International : Respecter les dispositions réglementaires locales.
- Pour garantir la protection IP/NEMA veiller à l'étanchéité des conduits.
- Les barrières sécurité intrinsèque recommandées sont indiquées sous *Barrières passives à diodes shunt* page 12.
- Consulter *Instructions spécifiques pour l'installation en zone dangereuse* page 13 ainsi que le certificat ATEX indiqué ci-dessus.

N.B. : Pour sélectionner un module d'entrée API, une alimentation électrique ou une barrière approprié(e) il est nécessaire de maîtriser les principes de sécurité intrinsèque et l'application. L'installateur doit s'assurer que la sécurité intrinsèque de l'installation soit conforme aux exigences d'agrément de l'instrument ainsi qu'aux règles et normes d'utilisation applicables.

Barrières passives à diodes shunt

N.B. : Requiert une tension d'alimentation bien régulée.

Fabricant	Numéro de pièce
MTL	787SP+ (Double)
MTL	7787P+ (Double)
Stahl	9001/01-280-100-10 (Simple)
Stahl	9002/01-280-110-10 (Double)

Procédure pour vérifier une barrière passive associée au SITRANS LR200

Les calculs suivants sont nécessaires pour s'assurer de la conformité de la barrière de sécurité aux paramètres d'entrée SI (sécurité intrinsèque) du LR200 :

- Re-e = max. résistance de la barrière de bout en bout
- Rloop = résistance de la boucle (résistance totale du câble et résistance perçue, affichages, et/ou entrées API par ex.)
- Vbarrier = valeur de toute chute de tension non linéaire provoquée par la barrière

- Définir la valeur de Re-e à partir des données sur la fiche technique.
- Calculer la valeur totale de Rloop : par l'addition de la résistance perçue, des affichages et/ou des entrées API par exemple.
- Calculer Rfonct = Re-e + Rloop.

- 4) Définir la valeur $V_{barrier}$ à partir des données sur la fiche technique (chute de tension provoquée par les diodes, par ex.).
- 5) Calculer $V_{fonct} = V_{lim} - V_{barrière}$.

Utiliser les valeurs $V_{working}$ et $R_{working}$ pour confirmer que l'appareil fonctionne suivant les seuils définis dans le graphique *Courbe 1 (Usage général, sécurité intrinsèque, protection non-incendiaire)* page 23.

Remarques :

- La liste suivante n'est pas exhaustive. vous pourrez choisir parmi plusieurs types d'alimentations électriques et barrières SI compatibles avec le LR200.
- Les modules d'entrée API et les barrières indiqués ci-dessus ont fait l'objet d'essais et sont compatibles avec le LR200.

Barrières actives (répétitrices)

Fabricant	Numéro de pièce
MTL	706
MTL	7206
Stahl	9001/51-280-110-14
Pepperl+Fuchs	KSD2-CI-S-Ex
Pepperl+Fuchs	KFD2-STC3-Ex1
MTL	E02009 - vérifier
MTL	E02010

Instructions spécifiques pour l'installation en zone dangereuse

(réf. Directive Européenne ATEX 94/9/CE, Annexe II, 1/0/6)

Les consignes ci-dessous s'appliquent à l'appareil objet des certificats n° SIRA 06ATEX2378X et SIRA 05ATEX1001X :

- 1) L'utilisation et l'assemblage sont décrits dans la version complète du manuel d'utilisation.
- 2) L'appareil est certifié en tant qu'instrument de la catégorie 1G.
- 3) L'appareil peut être utilisé en présence de gaz et de vapeurs inflammables, avec des instruments de groupe IIC, IIB et IIA, classification de température T1, T2, T3 et T4.
- 4) L'appareil est certifié pour utilisation dans une plage de température ambiante de -40 °C à $+80\text{ °C}$.
- 5) Conformément à la Directive 94/9/CE Annexe II, clause 1.5, cet appareil n'est pas considéré un dispositif de sécurité.
- 6) L'installation et la vérification de cet appareil doivent être effectuées par un personnel qualifié, en accord avec le code de bonne pratique applicable (EN 60079-14 et EN 60079-17 pour l'Europe).

- 7) L'appareil ne peut pas être réparé.
- 8) Les numéros de certificat comportent le suffixe 'X', imposant des conditions spéciales pour garantir la sécurité. Toute personne habilitée à installer ou à vérifier cet appareil doit avoir accès aux certificats.
- 9) Lorsque l'appareil peut entrer en contact avec des substances agressives, il incombe à l'utilisateur de prendre les mesures adéquates pour empêcher sa détérioration et garantir l'indice de protection.

Substances agressives : liquides ou gaz acides pouvant affecter des métaux ou solvants pouvant affecter des matériaux polymérisés.

Mesures adéquates : (exemple) déterminer, à l'aide de la fiche technique, si le produit résiste à certaines substances chimiques.

Activation du SITRANS LR200

Mettre l'appareil sous tension. Le SITRANS LR200 démarre automatiquement en mode de Mesure. (Pour modifier la langue affichée se reporter à *Sélection d'une option indiquée (sélection d'une langue, par ex.)* page 17.)

Affichage LCD

Mode de Mesure (fonctionnement normal)

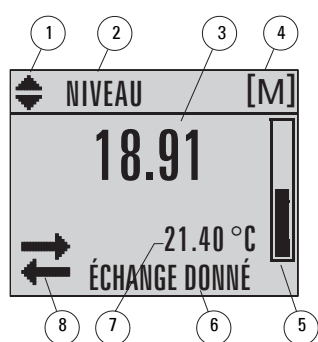

- 1 – indicateur d'affichage alterné, unités linéaires ou %
- 2 – mode de fonctionnement sélectionné : niveau, espace ou distance
- 3 – valeur mesurée (niveau ou volume, espace ou distance)
- 4 – unités
- 5 – représentation du niveau (bargraph)
- 6 – zone secondaire pour affichage (sur demande)¹⁾ de la température de l'électronique, de la fiabilité de l'écho, du courant de boucle ou de la distance
- 7 – zone dédiée à l'affichage de messages de texte
- 8 – indicateur de l'état de l'appareil

Défaut signalé



S: 0 LOE

- 7 – zone de texte avec indication d'un code/message d'erreur
- 8 – affichage de l'icône associée à la maintenance

Mode PROGRAM

Visualisation durant la navigation

- L'affichage de la barre de menu indique que le menu est trop long pour être affiché en entier.

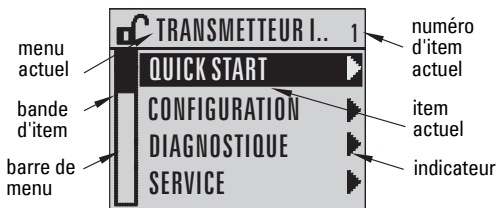

¹⁾ En réponse à la demande d'appui d'une touche : cf. *Utilisation des touches en mode de Mesure* page 15.

Visualisation de paramètres

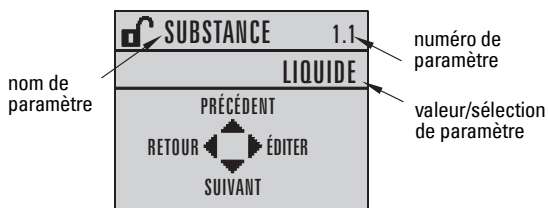

Visualisation en mode édition

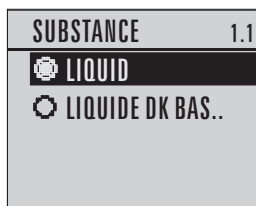

- Plus l'icône de la barre de défilement est haute, plus la liste de menus sera longue.

Programmeur portatif





(Réf. produit 7ML1930-1BK)

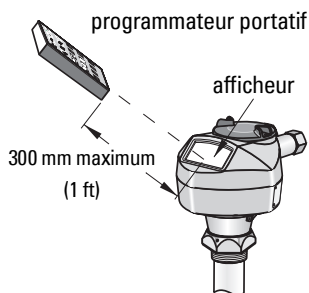



Le programmeur doit être commandé séparément.

- Diriger le programmeur vers l'affichage (distance maximum : 300 mm [1 ft.]).
- Appuyer sur  Mode pour alterner entre le mode Mesure et PROGRAM.



Utilisation des touches en mode de Mesure

Touche	Fonction	Résultat
	Mode permet d'accéder au mode PROGRAM.	Accède au dernier niveau de menu affiché durant le cycle de fonctionnement en cours, ou au niveau de menu 1 si l'appareil a été remis sous tension en quittant le mode PROGRAM ou si plus de 10 minutes se sont écoulées depuis l'utilisation du mode PROGRAM.
	Flèche DROITE accès au mode PROGRAM.	Accès au niveau menu 1.
 	Flèche ASCENDANTE ou DESCENDANTE affichage alterné : unités linéaires et %	Affichage (LCD) de la valeur mesurée, en unité linéaires ou en pourcent.

Touche	Fonction	Résultat
	Actualise le courant de boucle.	La nouvelle valeur est indiquée dans la zone secondaire de l'affichage LCD.
	Actualise l'affichage de la température interne du boîtier.	
	Actualise l'affichage de la fiabilité de l'écho.	
	Actualise l'affichage de la distance.	

Programmation du SITRANS LR200

Remarque : La non-utilisation du SITRANS LR200 en mode PROGRAM durant une période allant de 15 secondes à 10 minutes (suivant le niveau de menu) entraîne le retour automatique au mode de Mesure.

Les valeurs peuvent être modifiées localement avec l'interface appropriée ou à distance avec SIMATIC PDM. L'interface utilisateur (LUI) se compose d'un affichage à cristaux liquides et d'un programmeur portatif.

- Se reporter à *Accès à l'assistant de mise en service avec le programmeur portatif* page 18.
- Voir *Assistant de mise en service via SIMATIC PDM* page 21.

Menus des paramètres

N.B. : Pour une liste exhaustive des paramètres et des instructions correspondantes consulter la version complète du manuel. Téléchargez le schéma de la page produit sur notre site web : www.siemens.com/LR200

Les paramètres sont identifiés par leur nom, répartis en groupes de fonction et présentés sous forme de menus à 5 niveaux.







1. QUICK START
2. SETUP
3. DIAGNOSTIC
 - 3.14. VALEURS MESURE
 - 3.14.1. TEMP. INT. ACTUELLE

Accès aux paramètres à travers le programmeur portatif

1. Accéder au mode PROGRAM

- a) Diriger le programmeur vers l'affichage (distance maximum : 300 mm [1 ft.]).
- b) Appuyer sur la **flèche DROITE**  pour accéder au niveau menu 1.

2. Navigation : touches principales, mode Navigation

Touche	Nom	Niveau menu	Fonction
 	Flèche ASCENDANTE ou DESCENDANTE	Menu ou paramètre	<ul style="list-style-type: none"> Accéder au menu ou au paramètre suivant
	Flèche DROITE	Menu	<ul style="list-style-type: none"> Accéder au première paramètre du menu sélectionné ou accéder au menu suivant
		Paramètre	<ul style="list-style-type: none"> Accéder au mode Edition
	Flèche GAUCHE	Menu ou paramètre	<ul style="list-style-type: none"> Accéder au menu parent
	Mode	Menu ou paramètre	<ul style="list-style-type: none"> Accéder au mode de MESURE
	Début	Menu ou paramètre	<ul style="list-style-type: none"> Accéder au niveau menu 1

3. Edition en mode PROGRAM

Sélection d'une option indiquée (sélection d'une langue, par ex.)

a) Accéder à **Language (Langue), (7)**.

b) Appuyer sur la **flèche DROITE**  pour visualiser le paramètre.

c) Appuyer de nouveau sur la **flèche DROITE**

 pour accéder au mode **Edition**.

La valeur sélectionnée est accentuée.

d) Accéder à la nouvelle valeur sélectionnée.

Appuyer sur la **flèche DROITE**  pour valider. L'affichage LCD revient aux paramètres et indique la nouvelle valeur sélectionnée.

e) Appuyer sur la flèche **GAUCHE**  pour revenir au menu.

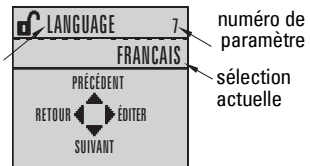

numéro de paramètre

sélection actuelle



Modification d'une valeur numérique

a) Accéder au paramètre souhaité.

b) Appuyer sur la **flèche DROITE**  pour visualiser le paramètre. La valeur actuelle est affichée.

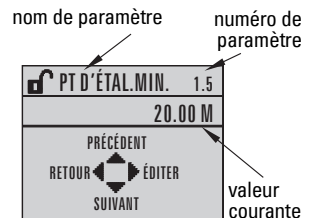

nom de paramètre

numéro de paramètre









valeur courante

- c) Appuyer de nouveau sur la **flèche DROITE**  pour accéder au **mode** Edition. La valeur actuelle est accentuée.



- d) Entrer une nouvelle valeur et utiliser la **FLECHE droite**  pour la valider. L'affichage LCD revient aux paramètres et indique la nouvelle valeur sélectionnée.



Utilisation des touches en mode Edition





Touche	Nom	Fonction
 	Flèche ASCENDANTE ou DESCENDANTE	Sélection d'options <ul style="list-style-type: none"> • Accès à l'item.
		Edition numérique <ul style="list-style-type: none"> • Augmente ou diminue les chiffres • Alterne les signes plus et moins
	Flèche DROITE	Sélection d'options <ul style="list-style-type: none"> • Accepte les données (modifie le paramètre) • Commute du mode Edition au mode Navigation
		Edition numérique <ul style="list-style-type: none"> • Déplace le curseur d'un espace vers la droite • ou avec le curseur sur l'icône Enter, valide les données et permet de commuter du mode Edition au mode Navigation
	Flèche GAUCHE	Sélection d'options <ul style="list-style-type: none"> • Annule le mode Edition sans modifier le paramètre
		Edition numérique <ul style="list-style-type: none"> • Déplace le curseur sur les signes plus/moins lorsqu'il s'agit de la première touche utilisée • ou déplace le curseur d'un caractère vers la gauche
	Effacer	Edition numérique <ul style="list-style-type: none"> • Efface les valeurs affichées
	Virgule décimale	Edition numérique <ul style="list-style-type: none"> • Introduit la virgule décimale
	Signe + / -	Edition numérique <ul style="list-style-type: none"> • Modifie le signe de la valeur introduite
 à 	Chiffre	Edition numérique <ul style="list-style-type: none"> • Introduit le caractère correspondant

Accès à l'assistant de mise en service avec le programmeur portatif

N.B. : L'activation de l'Assistant de mise en service entraîne l'application des valeurs par défaut. L'Assistant ne permet pas de restaurer les valeurs définies précédemment par l'utilisateur.

1. Mise en service rapide

- Diriger le programmeur vers l'affichage (à une distance max. de 300 mm [1 ft.]), et appuyer sur la **flèche DROITE**  pour accéder au mode PROGRAM et ouvrir le niveau menu 1.
- Appuyer deux fois sur la **flèche DROITE**  pour accéder à l'item menu 1.1 et visualiser les paramètres.

- c) Appuyer sur la **flèche DROITE**  pour accéder au mode **Edition** ou sur la **flèche ASCENDANTE**  pour valider les valeurs par défaut et accéder directement à l'item suivant.
- d) Pour modifier une valeur, accéder à l'item souhaité ou entrer une nouvelle valeur.
- e) Pour confirmer une valeur, appuyer sur la **flèche DROITE**  et sur la **flèche DESCENDANTE**  pour accéder à l'item suivant.
- f) Les réglages effectués durant la mise en service rapide doivent être validés en sélectionnant **Yes (Oui)** en réponse à **Apply changes (Appliquer modifications)** dans l'étape 1.7.

1.1. Produit

Options	LIQUID(E)
	LIQUID LOW DK (liquide faiblement diélectrique)

1.2. Temps de réponse

Définit la vitesse de réaction de l'appareil aux variations de mesure dans la plage spécifiée.

Options	LENTE	0,1 m/minute
	MOYENNE	1,0 m/minute
	RAPIDE	10,0 m/minute

Sélectionner une vitesse légèrement supérieure à la vitesse de remplissage ou de vidange maximale (la plus élevée des deux).

1.3. Unités capteur

Définit l'unité applicable aux variables de la Mise en service rapide (point d'étalonnage min./max., niveau, distance, espace).

Options	M, CM, MM, FT, IN
----------------	-------------------

1.4. Fonctionnement

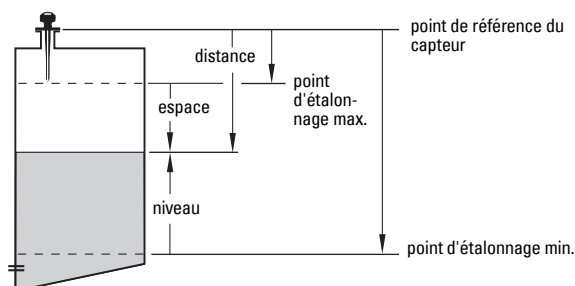

Types de fonctionnement	PAS DE FONCT.	Le SITRANS LR200 n'actualise plus les mesures et le courant de boucle correspondant. L'instrument indique la dernière mesure valide.
	NIVEAU	Distance entre le point d'étalonnage minimum (niveau process vide) et la surface du matériau.
	ESPACE	Distance entre la surface du matériau et le point d'étalonnage max. (niveau process plein).
	DISTANCE	Distance entre le point de référence du capteur et la surface du matériau.

1.5. Point d'étalonnage min.

Distance entre le point de référence du capteur et le point d'étalonnage min. : généralement le niveau process vide.

Valeurs	Plage : 0,0000 ... 20.000 m
----------------	-----------------------------

1.6. Point d'étalonnage max.

Distance entre le point de référence du capteur et le point d'étalonnage max. : généralement le niveau process plein.

Valeurs	Plage : 0,0000 ... 20.000 m
----------------	-----------------------------

1.7. Appliquer? (valider les modifications)



Pour sauvegarder les modifications effectuées durant la mise en sce rapide, sélectionner **Yes**.

Options	YES, NO (OUI, NON)
----------------	--------------------

L'affichage indique **DONE (TERMINE)** à la fin de la Mise en service.

Appuyer sur **Mode**  pour revenir au mode de Mesure. Le SITRANS LR200 est prêt à fonctionner.

Obtention d'un profil écho

- 1) En mode PROGRAM, accéder à : **Level Meter (Transmetteur de niveau) > Diagnostics (Diagnostic) (3) > Profil écho (3.1)**.
- 2) Appuyer sur la **flèche DROITE**  pour demander un profil.
- 3) Dans le champ Profil, appuyer sur la **flèche ASCENDANTE**  pour sélectionner l'icône **Transmission** et sur la **flèche DROITE**  pour actualiser le profil.
- 4) Appuyer sur la **flèche DESCENDANTE**  pour sélectionner l'icône **Exit (Sortie)** et sur la **flèche DROITE**  pour revenir au menu précédent.

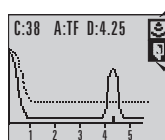

icône de transmission, non sélectionnée

icône de sortie, sélectionnée

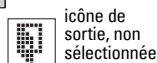

Communication SITRANS LR200 : HART

- Vous trouverez des explications détaillées sur les paramètres applicables dans la version complète du manuel d'utilisation.
- Nous vous conseillons de programmer l'appareil avec SIMATIC Process Device Manager (PDM).

SIMATIC PDM

N.B. :

- Nous vous conseillons d'utiliser SIMATIC PDM V 6.0 SP3 ou une version ultérieure.
- Accès via SIMATIC PDM V 5.2 SP1 pour la configuration et le diagnostic de base uniquement. Les fonctions avancées telles que l'Assistant de mise en service nécessitent la version 6.0 SP3 (ou ultérieure).

Le logiciel SIMATIC PDM est utilisé pour la configuration et la maintenance d'appareils tels que le SITRANS LR200. Pour plus de détails sur l'utilisation de SIMATIC PDM, consulter le guide de fonctionnement ou l'aide en ligne. (Pour plus d'informations, voir www.fielddevices.com, rubrique **Products and Solutions > Products and Systems > Communications and Software > Process Device Manager.**)

Electronic Device Description (EDD)

- Cette description (EDD) est à votre disposition dans la rubrique Device Catalog, sous **Sensors/Level/Echo/Siemens Milltronics/SITRANS LR200**.
- Consulter la page produit sur notre site web : www.siemens.com/LR200, rubrique **Downloads/Téléchargements**, pour obtenir la dernière version de SIMATIC PDM, le dernier SP (Service Pack) et le dernier HF (hot fix). L'installation du fichier EDD est décrite dans *Configuration d'un nouvel appareil* ci-dessous.

Configuration d'un nouvel appareil

Remarque : La sélection de **Cancel (Annulation)** durant l'actualisation (appareil vers SIMATIC PDM) entraînera l'actualisation de certains paramètres.

1. Il est impératif d'utiliser le tout dernier fichier EDD. Vous pouvez, si nécessaire, le télécharger de la page produit indiquée ci-dessus. Sauvegarder les fichiers sur l'ordinateur. Extraire le fichier zippé vers un emplacement accessible. Lancer **SIMATIC PDM – Manager Device Catalog**, accéder au fichier EDD dézippé et le sélectionner.
2. Lancer SIMATIC PDM et créer un nouveau projet pour le LR200. Les guides d'application concernant le paramétrage d'appareils HART avec SIMATIC PDM sont disponibles sur la page produit de notre site internet : www.siemens.com/LR200.
3. Copier les paramètres vers le PC/PG.
4. Régler l'appareil suivant les instructions fournies par l'Assistant de mise en service (voir ci-dessus).

Assistant de mise en service via SIMATIC PDM

N.B. :

- Il existe un lien entre les différents réglages de Mise en service rapide. Pour valider les modifications, sélectionner **Transfert (Transférer)** après l'étape 5.
- L'activation de l'Assistant de mise en service entraîne l'application des valeurs par défaut. L'Assistant ne permet pas de restaurer les valeurs définies précédemment par l'utilisateur.
- Sélectionner **Back (Retour)** pour revenir à une valeur et la modifier ou **Cancel (Annuler)** pour quitter la Mise en service.

Lancer SIMATIC PDM, ouvrir le menu **Appareil – Mise en service rapide**, et suivre les étapes 1 à 5.

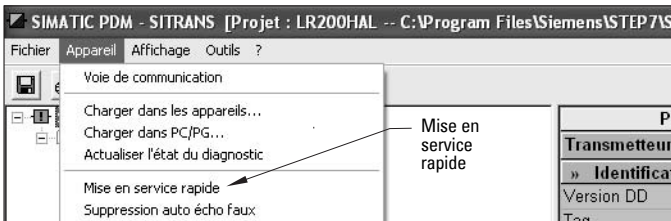

Maintenance

Utilisé en conditions de fonctionnement normales, le SITRANS LR200 ne requiert pas de maintenance ou de nettoyage. Si le nettoyage s'avère nécessaire :

1. Choisir un produit de nettoyage en fonction du matériau de construction de l'antenne et du produit dans le process contrôlé.
2. Retirer l'appareil de l'application et nettoyer l'antenne avec un tissu et un produit adapté.

Réparation de l'appareil et limite de responsabilité

Pour plus de détails, veuillez vous reporter à la dernière page.

Température de process maximum

! AVERTISSEMENT : La température interne ne doit pas dépasser 80 °C (176 °F).

Températures maximales bride et process/température ambiante admissible, versions SITRANS LR200 avec adaptateur bride

- Le graphique est fourni à titre indicatif uniquement.
- Seule une partie des raccords process possibles est illustrée. Exemple : il ne s'applique PAS lorsque le SITRANS LR200 est fixé directement sur une surface métallique du réservoir.
- Ce graphique ne tient pas compte de la chaleur due à l'exposition de l'instrument au soleil.
- Le paramètre 3.14.1 permet de contrôler la valeur actuelle de la température interne.

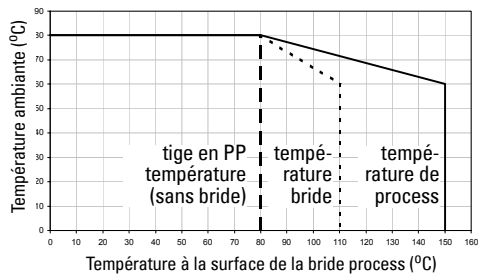

Boucle de courant

Schéma de connexion typique

N.B. : La tension de boucle correspond à la tension enregistrée aux bornes de l'alimentation (et pas à la tension aux bornes de l'appareil).

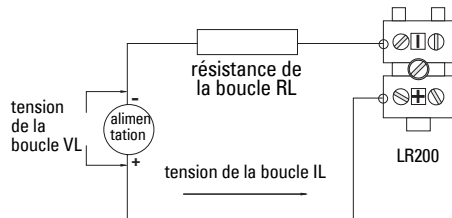

Zone de fonctionnement autorisée

Courbe 1 (Usage général, sécurité intrinsèque, protection non-incendiaire)

**Tension de la boucle/
résistance de la boucle**

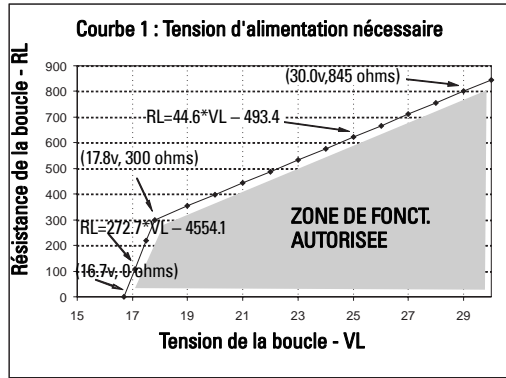

Courbe 2 (Enveloppe antidéflagrante, sécurité augmentée, protection contre les explosions)

**Tension de la boucle/
résistance de la boucle**

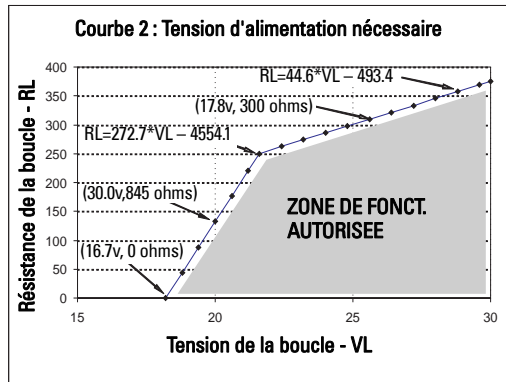

Courbe de démarrage

N.B. : Au démarrage, l'appareil peut nécessiter 25 à 55 secondes avant de fournir la mesure du niveau de produit dans le réservoir.

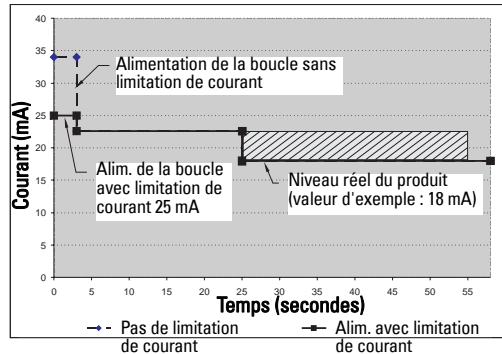

Français

Remarques

Guida di avvio rapido SITRANS LR200 (HART) con interfaccia locale LUI Siemens

Questo manuale descrive le caratteristiche e le funzioni più importanti del SITRANS LR200 (HART). Si consiglia all'operatore di leggere il manuale d'uso integrale per ottenere i massimi risultati. Il manuale integrale è disponibile sulla pagina prodotto SITRANS LR200 del nostro sito web: www.siemens.com/LR200. Per la versione stampata, rivolgersi al proprio rappresentante di Siemens Milltronics.

Per ulteriori informazioni su questo manuale, rivolgersi a:

Siemens Milltronics Process Instruments Inc.
1954 Technology Drive, P.O. Box 4225
Peterborough, Ontario, Canada, K9J 7B1
Email: techpubs.smpi@siemens.com

**Copyright Siemens Milltronics
Process Instruments Inc. 2008.
Tutti i diritti riservati**

Clausola di esclusione della responsabilità

Si consiglia agli utenti di acquisire manuali stampati autorizzati oppure di consultare le versioni elettroniche progettate e realizzate da Siemens Milltronics Process Instruments Inc. Siemens Milltronics Process Instruments Inc. non potrà essere ritenuta responsabile per la riproduzione parziale o totale del contenuto delle versioni stampate o elettroniche.

La conformità tra lo stato tecnico dell'apparecchio e il contenuto di questo manuale è stata verificata; tuttavia, potrebbero essere riscontrate alcune variazioni. SMPI non garantisce pertanto la completa conformità del manuale con l'apparecchio descritto. Si avvisa inoltre che tutti i manuali vengono regolarmente controllati ed aggiornati e che le eventuali correzioni vengono incluse nelle versioni successive. Si invitano gli utenti a trasmettere i propri suggerimenti e commenti a SMPI. SMPI si riserva il diritto di apportare modifiche tecniche.

MILLTRONICS è un marchio registrato di Siemens Milltronics Process Instruments Inc.

Supporto tecnico

Il servizio è disponibile 24 ore su 24.

Per trovare l'ufficio di rappresentanza Siemens Automation più vicino, consultare il sito web:

www.siemens.com/automation/partner:

- (Scegliere la lingua: italiano). Aprire il tab **Interlocutore per prodotti**, scegliere il prodotto **(+Automazione di processo > +Strum. di processi > +Strumenti per la misura di livello)**.
- Selezionare il **Supporto Tecnico**. Cliccare su **Avanti**.
- Scegliere il continente, il paese e la città. Cliccare su **Avanti**.

Supporto tecnico on-line: www.siemens.com/automation/support-request

- Introdurre il nome dell'apparecchio (SITRANS LR200) o il numero dell'ordine di acquisto, cliccare su **Cerca**, e selezionare il tipo di prodotto. Cliccare su **Avanti**.
- Introdurre un keyword per la richiesta. Visualizzare la documentazione o cliccare su **Avanti** per inviare una descrizione della richiesta via e-mail al Supporto Tecnico.

Centro di Supporto Tecnico Siemens A&D:

Tel. +49 180 50 50 222

Fax +49 180 50 50 223

Indicazioni di sicurezza

L'apparecchio deve essere utilizzato osservando le avvertenze. Un utilizzo non corretto potrebbe causare danni anche gravi alle persone, sia al prodotto e agli apparecchi ad esso collegati. Le avvertenze contengono una spiegazione dettagliata del livello di sicurezza da osservare.



ATTENZIONE: questo simbolo sul prodotto indica che la mancata osservazione delle precauzioni necessarie può causare morte o gravi lesioni personali nonché seri danni materiali.



ATTENZIONE¹⁾: questo simbolo indica che la mancata osservazione delle precauzioni necessarie può causare morte o gravi lesioni personali nonché seri danni materiali.

Nota: le note contengono importanti informazioni sul prodotto o sulla sezione del manuale d'istruzioni a cui viene fatto riferimento.

Conformità FCC

Installazioni negli USA: Regole della FCC (Federal Communications Commission)



ATTENZIONE: Ogni cambiamento o modifica non espressamente approvato da Siemens Milltronics potrebbe revocare il diritto all'utilizzo dell'apparecchio.

Note:

- Il presente apparecchio è stato collaudato e risultato conforme ai vincoli relativi ai dispositivi digitali di Classe A, inclusi nella Parte 15 della normativa FCC. Tali vincoli sono stati stabiliti ai fini di garantire un'adatta protezione da interferenze dannose durante l'utilizzo dell'apparecchio in ambienti commerciali.
- Il presente apparecchio genera, utilizza e può emettere energia in radio frequenza. Se installata e utilizzata in modo improprio, vale a dire in difformità con il relativo manuale d'istruzioni, il presente apparecchio può causare interferenze dannose alle radiocomunicazioni. L'impiego del presente apparecchio all'interno di una zona residenziale potrebbe causare interferenze dannose. In tal caso, l'utente dovrà risolvere il problema ed eliminare tali interferenze a proprie spese.

SITRANS LR200



ATTENZIONE: Per garantire la protezione il SITRANS LR200 deve essere utilizzato osservando le istruzioni e avvertenze contenute in questo manuale.

Nota: Il presente apparecchio è stato progettato e prodotto per l'uso in ambienti industriali. L'uso in zone residenziali può causare disturbi alle comunicazioni radiofoniche.

SITRANS LR200 è un misuratore di livello a circuito alimentato a due fili per campi di misura fino a 20 m (66 ft). Utilizza una tecnologia radar ad impulsi 6 GHz per misurare liquidi e slurry nei serbatoi di stoccaggio con condizioni di lavoro pericolose quali pressione e alte temperature.

I componenti dell'apparecchio sono: la custodia con l'elettronica collegata ad un'antenna, e l'attacco di processo filettato o a flangia.

¹⁾ Questo simbolo viene usato se sul prodotto non appare il corrispondente simbolo di avvertimento.

Comunicazione via HART¹⁾. L'elaborazione dei segnali è effettuata grazie alla Process Intelligence.

Specifiche tecniche

Il dati tecnici completi sono descritti nel manuale di istruzioni SITRANS LR200 (HART). Per informazioni sulle omologazioni, consultare la targhetta sull'apparecchiatura e sull'etichetta.

Temperatura ambiente/di funzionamento

Note:

- Le caratteristiche relative alle condizioni ambientali quali temperatura di processo e pressione sono specificate sull'apposita etichetta dell'apparecchio. L'illustrazione di riferimento citata sull'etichetta può essere scaricata direttamente dal sito Siemens: www.siemens.com/LR200.
- La temperatura massima di funzionamento dipende dalla connessione al processo, i materiali utilizzati per l'antenna e la pressione (serbatoio). Per ulteriori dettagli vedere *Grafico della temperatura massima di lavoro* pagina 22. Le curve di limitazione della pressione/temperatura di lavoro sono riportate nel manuale integrale.

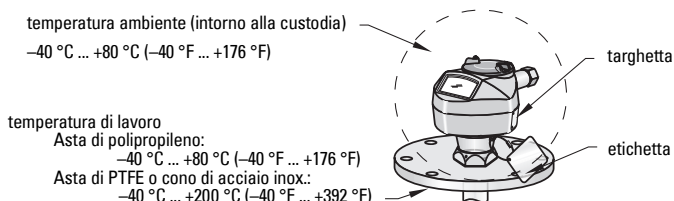

Alimentazione



Uso generale:

Non incendiario (solo FM/USA):
Intrinsecamente sicuro:

Nominale 24 V DC, max.
resistenza del loop 550 Ohm.



Antideflagrante:

Sicurezza aumentata:
A prova di esplosione (FM/CSA solo USA/Canada):

Nominale 24 V DC, max.
resistenza del loop 250 Ohm.

Certificazioni

- Generali CSA_{US/C}, FM, CE
- Radio Europa (R&TTE), FCC, Industry Canada

(segue pagina successiva)

¹⁾ HART® è un marchio registrato della HART Communication Foundation.

- Zone pericolose Antideflagrante (Europa)¹⁾ ATEX II 1/2 G, EEx dm ia IIC T4
- Sicurezza aumentata (Europa)²⁾ ATEX II 1/2 G, EEx em ia IIC T4
- Antideflagrante (USA/Canada)³⁾ FM/CSA: (non richiede isolamento)
- Classe I, Div. 1, Gruppi A, B, C, D
- Classe II, Div. 1, Gruppi E, F, G
- Classe III T4

Nota: Utilizzare guarnizioni adatte a tenuta stagna per garantire il grado di protezione IP/ NEMA.

Certificazioni (segue)

- Zone pericolose:
 - Non incendiario (US)⁴⁾ FM: (non richiede barriera)
 - Class I, Div. 2, Groups A, B, C, DT5
 - Intrinsecamente sicuro⁵⁾
 - (Europa) ATEX II 1 G, EEx ia IIC T4
 - (USA/Canada) FM/CSA: (richiede barriera)
 - Classe I, Div. 1, Gruppi A, B, C, D
 - Classe II, Div. 1, Gruppi E, F, G
 - Classe III T4
 - (Australia) ANZEX Ex ia IIC T4
 - (Tamb = -40 ... +80 °C) IP67
 - (Internazionale) IECEX TSA 04.0020X T4
- Marittima: Lloyd's Register of Shipping
- Certificazione ABS (American Bureau of Shipping)

Programmatore (tastiera ad infrarossi)

Programmatore portatile ad infrarossi Siemens Milltronics, intrinsecamente sicuro per zone pericolose e altre installazioni (batteria non sostituibile con durata di vita di 10 anni in condizioni di funzionamento normali).

- Certificazione ATEX II 1 G, EEx ia IIC T4, certificato SIRA 01ATEX2147
- FM/CSA: Classe I, Div. 1, Gruppi A, B, C, D
- Temperatura ambiente -20 ... 40 °C (-5 ... 104 °F)
- Interfaccia proprietaria ad infrarossi
- Pila 3 V al litio
- Peso 150 g (0.3 lb)
- Colore nero
- Numero pezzo 7ML1930-1BK

¹⁾ Consultare *Cablaggio antideflagrante* pagina 9.

²⁾ Consultare *Cablaggio di sicurezza aumentata* pagina 10.

³⁾ Consultare *A prova di esplosione (FM/CSA solo USA/Canada)* pagina 10.

⁴⁾ Consultare *Cablaggio non a rischio d'incendio (solo FM/USA):* pagina 11.

⁵⁾ Consultare *Cablaggio intrinsecamente sicuro* pagina 11.

Applicazioni a pressione



- **ATTENZIONE:**
- **Questa apparecchiatura è stata definita accessorio a pressione nell'ambito della Direttiva 97 / 23 / CE e non è destinata ad essere utilizzata come dispositivo di sicurezza.**
- **Non svitare, smontare o rimuovere la connessione di processo o la custodia dell'apparecchiatura quando il contenuto del serbatoio è sotto pressione.**
- **L'installazione errata può provocare un calo della pressione di lavoro.**

Installazione



- **ATTENZIONE:**
- **L'installazione deve essere eseguita esclusivamente da personale qualificato e in conformità con le normative locali correnti.**
- **I materiali di composizione vengono scelti in base alla compatibilità chimica (o inerzia) per uso generico. Per l'esposizione in ambienti specifici, verificare il grafico della compatibilità chimica prima di procedere all'installazione.**

Note:

- E' importante lasciare l'etichetta di identificazione collegata all'insieme che delimita la soglia della pressione di lavoro¹⁾. In caso di sostituzione dell'apparecchio, assicurarsi che venga spostata l'apposita etichetta di identificazione.
- Gli apparecchi SITRANS LR200 sono sottoposti a prove idrostatiche e rispettano rigorosamente ed eccedono gli standard stabiliti dall'ASME (Boiler and Pressure Vessel Code) e dalla direttiva Europea PED sulle attrezzature in pressione.

Installazione

- Installare l'apparecchiatura in modo da ottenere un accesso facilitato al display, per la visualizzazione e il controllo nonché per la programmazione tramite il programmatore portatile.
- Installare l'apparecchio in un ambiente idoneo alle caratteristiche e ai materiali di costruzione della custodia.
- E' opportuno prevedere un rivestimento di protezione solare se l'apparecchiatura deve essere esposta al sole.

¹⁾ L'apparecchiatura è dotata di un'insieme di componenti che delimitano la soglia della pressione di lavoro ed agiscono come barriera contro le perdite di pressione dal serbatoio di processo. L'insieme è composto dall'attacco di processo (corpo-emettore), generalmente senza la custodia con elettronica.

Tipo di tronchetto

Note:

- Per tronchetti di prolunga di lunghezza 100 mm (4") o inferiore è opportuno utilizzare lo schermo di 100 mm (4").
- Per tronchetti di prolunga di lunghezza 250 mm (10") o inferiore è opportuno utilizzare lo schermo di 250 mm (10").
- Altri esempi di applicazioni sono descritti in dettaglio nel manuale d'uso integrale.

- L'estremo della sezione schermo deve sporgere di almeno 10 mm (0.4" per impedire la riflessione di falsi echi sul tronchetto.

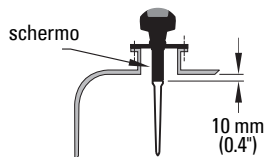

Montaggio dell'apparecchio su una portella

- La portella coperchia è generalmente un tronchetto chiuso di diametro 610 mm (24") o superiore.
- Al fine di ottimizzare la trasmissione del segnale occorre posizionare l'antenna a un'adeguata distanza dalla parete del serbatoio, generalmente 100 mm (4").

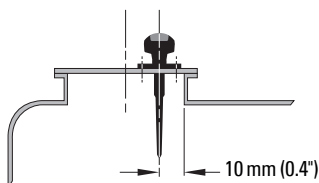

Montaggio tronchetto

ATTENZIONE: Evitare l'installazione centrale su serbatoi dotati di tetto conico o parabolico. (La concavità del tetto possono focalizzare gli echi nella parte centrale e provocare misure erronee.)

Nota: In determinate circostanze è possibile montare l'apparecchio nel centro di un serbatoio a tetto piatto. Per ulteriori informazioni si consiglia di rivolgersi al proprio rappresentante Siemens.

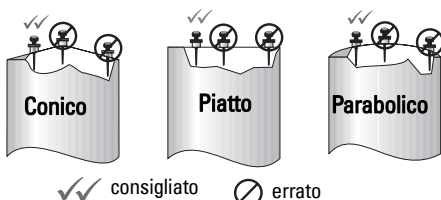

- Mantenere il cono di emissione libero da qualsiasi interferenza da scale, tubi, assali a doppio T o flussi di carico.
- Installare l'antenna lontano dalla parete del serbatoio per evitare interferenze ed echi di disturbo.
- Prevedere lo spazio libero necessario per la propagazione del fascio e evitare interferenze con le pareti del serbatoio o eventuali ostacoli.

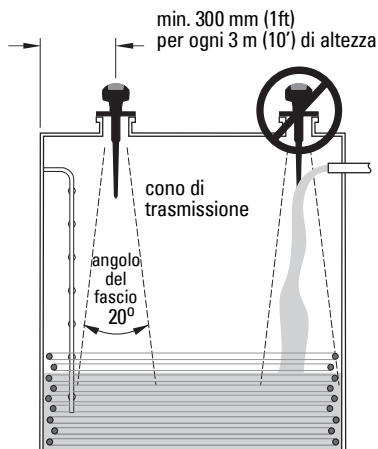

Istruzioni per l'installazione

Note:

- La custodia dell'apparecchio può essere ruotata innumerevoli volte.
- Dirigere la parte frontale o posteriore della custodia verso la parete più vicina del serbatoio.
- Non ruotare la custodia dopo la programmazione e la configurazione dell'apparecchio onde evitare che si verifichi un errore causato dall'inversione di polarità dell'impulso di trasmissione.

Versione filettata

- 1) Prima di inserire l'apparecchio nell'attacco di collegamento, verificare la corrispondenza delle filettature onde evitare di danneggiarle.
- 2) Avvitare l'apparecchio sull'attacco di processo e fissare manualmente. Per applicazioni a pressione, utilizzare un nastro PTFE (o un altro composto appropriato per sigillare le filettature) e stringere ulteriormente l'attacco di collegamento all'apparecchio rispetto alla chiusura manuale (torsione consigliata 40 Nm (30 ft.lbs)).
- 3) Per ruotare la custodia, allentare le tre viti di arresto della ghiera di bloccaggio. Posizionare la custodia, quindi stringere nuovamente le viti.



Versione flangiata

- !** **ATTENZIONE:** L'utente è responsabile della selezione dei materiali quali bulloni o guarnizioni che consentano di rispettare i limiti e l'uso appropriato della flangia e che siano adeguati alle condizioni di servizio.

Collegamento elettrico

Alimentazione

ATTENZIONE:



I terminali di ingresso CC devono essere alimentati da una fonte dotata di isolamento elettrico tra l'ingresso e l'uscita, per garantire la conformità ai requisiti di sicurezza applicabili della direttiva IEC 61010-1.



Tutti i collegamenti elettrici di campo devono disporre di adeguato isolamento per le tensioni di esercizio.

Collegamenti SITRANS LR200



ATTENZIONE:

- Per informazioni sulle omologazioni consultare la targhetta sull'apparecchiatura e l'apposita etichetta.
- Utilizzare guarnizioni adatte a tenuta stagna per garantire il grado di protezione IP o NEMA.
- Consultare *Istruzioni specifiche per zone potenzialmente esplosive* pagina 13.

Note:

- I collegamenti elettrici sono descritti in dettaglio nel manuale d'uso integrale.
- Utilizzare un cavo bifilare ritorto: calibro da AWG 22 a 14 (0.34 mm^2 a 2.5 mm^2).
- Potrà essere necessario separare i cavi e conduit in conformità con le procedure standard di cablaggio della strumentazione o con codici locali per materiali elettrici.

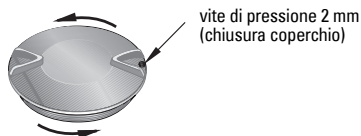

- 1) Allentare la vite di pressione del coperchio con una chiave a brugola da 2 mm e svitare il coperchio.
- 2) Rimuovere il rivestimento del cavo per circa 70 mm (2.75") partendo dall'estremità, quindi passare i fili attraverso il serracavo.
- 3) Collegare i fili con gli appositi morsetti seguendo il diagramma sottoriportato: la polarità viene indicata sul blocco terminale.
- 4) Effettuare il collegamento a terra dell'apparecchiatura attenendosi alle prescrizioni vigenti.
- 5) Avvitare il pressacavo per garantire la tenuta stagna.
- 6) Prima di effettuare la programmazione e la calibrazione è necessario chiudere il coperchio e fissare la ghiera di bloccaggio. Non ruotare la custodia dopo la configurazione dell'apparecchio onde si verifichi un errore.

Collegamenti HART: configurazione tipica PLC/mA

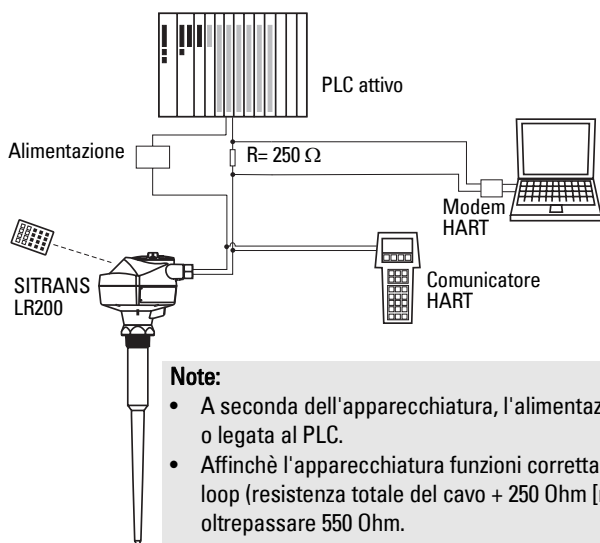

Possibilità di cablaggio per installazioni in zone potenzialmente esplosive

Nota: Le certificazioni ATEX e i diagrammi di collegamento sottoindicati sono scaricabili dalla pagina del nostro sito: www.siemens.com/LR200.

Per l'installazione in zone potenzialmente esplosive esistono cinque opzioni. L'importante in ogni caso è di controllare le certificazioni riportate sulla targhetta dell'apparecchiatura e sull'apposita etichetta.

1. Cablaggio antideflagrante

SIEMENS		II 1/2 G		HART	
SITRANS LR 200		II 1/2 G	EEx dmia IIC T4	HART	
7ML1234-56789-0ABC-D				Um = 250V	
Serial No: GYZ/S1034567		SIRA	05ATEX1001X		
End.: NEMA TYPE 4X, 6, IP67, IP68		CE	0682		
Amb. Temp.: -40°C to 80°C			0518		
Power Rating: 24V --- Nom., 30V --- Max., 4 - 20mA					
Siemens Milltronics Process Instruments Inc., Peterborough					
Made in Canada					

Tipo di omologazione	Validità	Rif.
ATEX II 1/2 G, EEx dm ia IIC T4	Europa	<i>Flameproof/Increased Safety: ATEX Certificate</i> alla pagina A-1.

- Per informazioni sull'alimentazione necessaria vedi *Curva 2 (Antideflagrante, sicurezza aumentata, a prova di esplosione)* pagina 23.
- Per il cablaggio attenersi alle prescrizioni vigenti.
- Vedi anche *Istruzioni specifiche per zone potenzialmente esplosive* pagina 13 e la certificazione ATEX sopraindicata.

2. Cablaggio di sicurezza aumentata

SIEMENS			
SITRANS LR200			
7ML1234-56789-0ABC-D			
SerialNo: GYZ/S1034567			
Encl.: NEMA/TYPEx 4X, 6, IP67, IP68			
Amb. Temp.: -40°C to 80°C			
Power Rating: 24V --- Nom. 30V --- Max. 4-20mA			
Siemens Milltronics Process Instruments Inc., Peterborough Made in Canada			

Tipo di omologazione	Validità	Rif.
ATEX II 1/2 G, EEx em ia IIC T4	Europa	<i>Flameproof/Increased Safety: ATEX Certificate</i> alla pagina A-1.

- Per informazioni sull'alimentazione necessaria vedi *Curva 2 (Antideflagrante, sicurezza aumentata, a prova di esplosione)* pagina 23.
- Per il cablaggio attenersi alle prescrizioni vigenti.
- Vedi anche *Istruzioni specifiche per zone potenzialmente esplosive* pagina 13 e la certificazione ATEX sopraindicata.

3. A prova di esplosione (FM/CSA solo USA/Canada)

SIEMENS			
SITRANS LR200			
7ML1234-56789-0ABC-D			
SerialNo: GYZ/S1034567			
Encl.: NEMA/TYPEx 4X, 6, IP67, IP68			
Amb. Temp.: -40°C to 80°C			
Power Rating: 24V --- Nom. 30V --- Max. 4-20mA			
Siemens Milltronics Process Instruments Inc., Peterborough Made in Canada			

FCC ID: NJA-LR 200
CANADA: 267P-LR 200
HART
WARNING: Do Not Remove Cover While Circuits Are Live

Tipo di omologazione	Validità	Rif.
FM/CSA: Classe I, Div. 1, Gruppi A, B, C, D Classe II, Div. 1, Gruppi E, F, G Classe III T4	USA/Canada	Diagramma di collegamento elettrico antideflagrante FM/CSA num. 23650597

- Per informazioni sull'alimentazione necessaria vedi *Curva 2 (Antideflagrante, sicurezza aumentata, a prova di esplosione)* pagina 23.
- Per informazioni sul cablaggio (solo per il Nord America) vedi il diagramma di collegamento sopraindicato, scaricabile dalla pagina prodotto del nostro sito internet: www.siemens.com/LR200.

4. Cablaggio non a rischio d'incendio (solo FM/USA):

SIEMENS	CANADA: 267P- FCC ID: NJA-LR200	 APPROVED	Class I, Div. 2, Group A, B, C, D Temp. Code: T5
7ML1234-56789-0ABC-D Serial No: GYZ / S1034567 Encl.: NEMA / TYPE 4X, 6, IP67 Amb. Temp.: -40 °C to 80 °C Power Rating: 24V \approx Nom., 30V \approx Max., 4-20mA			
Siemens Milltronics Process Instruments Inc., Peterborough Made in Canada			



This device complies with Part 15 of the FCC Rules.
Operation is subject to the following two conditions
1) This device may not cause harmful interference and
2) This device must accept any interference received, including interference that may cause undesired operation

Tipo di omologazione	Validità	Rif.
FM: Classe I, Div. 2, Gruppi A, B, C, D T5	USA	Diagramma di collegamento non a rischio d'incendio FM, num. 23650537

- Per informazioni sull'alimentazione necessaria vedi *Curva 1 (Uso generale, intrinsecamente sicuro, non incendiario)* pagina 23.
- Per informazioni sul cablaggio (solo per il Nord America) vedi il diagramma di collegamento sopraindicato, scaricabile dalla pagina prodotto del nostro sito internet: www.siemens.com/LR200.

5. Cablaggio intrinsecamente sicuro

SIEMENS	
SITRANS LR200 7ML1234-56789-0ABC-D Serial No: GYZ / S1034567 Encl.: NEMA / TYPE 4X, 6, IP67, IP68 Amb. Temp.: -40 °C to 80 °C Power Rating: 24V \approx Nom., 30V \approx Max., 4-20mA	
Siemens Milltronics Process Instruments Inc., Peterborough Made in Canada	

Class I, Div 1, Group A, B, C, D Class II, Div 1, Group E, F, G Class III Temp. Code: T4 HART	Vmax = 30 V Imax = 120 mA Pmax = 0.8 W Ci = 15 nF Li = 0.1 mH	 159134  APPROVED
CSA per drawing A5E01003039 FM per drawing A5E01003040	IC: 267P-LR200 FCC ID: NJA-LR200	
WARNING: Possible Static Hazard, Do Not Rub Or Clean On Site		

SIEMENS	
SITRANS LR200 7ML1234-56789-0ABC-D Serial No: GYZ / S1034567 Encl.: NEMA / TYPE 4X, 6, IP67, IP68 Amb. Temp.: -40 °C to 80 °C Power Rating: 24V \approx Nom., 30V \approx Max., 4-20mA	
Siemens Milltronics Process Instruments Inc., Peterborough Made in Canada	

II 1 G EEx ia IIC T4 SIRA 0GATEX2378X CE 0682 0518 HART 5.8 GHz	Ui = 30 V Ii = 120 mA Pi = 0.8 W Ci = 15 nF Li = 0.1 mH	IECEx TSA 04.0020X ANZEX 04.3016X Ex ia IIC T4 N117	 Sugarcap METRIC cap-1000
WARNING: Possible Static Hazard, Do Not Rub Or Clean On Site.			

Tipo di omologazione	Validità:	Rif.
FM/CSA: Classe I, Div. 1, Gruppi A, B, C, D Classe II, Div. 1, Gruppi E, F, G Classe III	USA/Canada	Diagramma di cablaggio intrinsecamente sicuro FM, num. A5E01003040 Diagramma di cablaggio intrinsecamente sicuro CSA, num. A5E01003039
ATEX II 1 G, EEx ia IIC T4	Europa	<i>Intrinsically Safe: ATEX Certificate alla pagina A-5</i>
ANZEX Ex ia IIC T4 (Tamb = -40 ... 80 °C) IP67	Australia	
IECEx TSA 04.0020X	Internazionale	

- Per informazioni sull'alimentazione necessaria vedi *Curva 1 (Uso generale, intrinsecamente sicuro, non incendiario)* pagina 23.

- Per informazioni sul cablaggio:
 Nord America: Vedi i diagrammi di collegamento sopraindicati, scaricabili dalla pagina Prodotto del nostro sito internet: www.siemens.com/LR200.
 Europa: Attenersi alle prescrizioni vigenti.
 Australia: Attenersi alle prescrizioni vigenti.
 Internazionale: Attenersi alle prescrizioni vigenti.
- Utilizzare guarnizioni adatte a tenuta stagna per garantire il grado di protezione IP o NEMA.
- I tipi di barriere di sicurezza intrinseca consigliati sono riportati nelle sezioni *Barriere a diodo derivatore passivo* pagina 12.
- Vedi *Istruzioni specifiche per zone potenzialmente esplosive* pagina 13 e la certificazione ATEX sopraindicata.

Nota: Per scegliere un modulo di ingresso, un'alimentazione o una barriera adatta per il PLC è necessario conoscere la sicurezza intrinseca e l'applicazione. L'installatore deve garantire che l'installazione intrinsecamente sicura sia conforme ai requisiti stabiliti dalla certificazione dell'apparecchiatura ed ai codici di procedura o le istruzioni di installazione applicabili.

Barriere a diodo derivatore passivo

Nota: L'apparecchiatura richiede una tensione di alimentazione regolata.

Marca, fabbricante	Numero pezzo
MTL	787SP+ (due canali)
MTL	7787P+ (due canali)
Stahl	9001/01-280-100-10 (un canale)
Stahl	9002/01-280-110-10 (un canale)

Come selezionare una barriera passiva per il SITRANS LR200

Per controllare che la descrizione della barriera di sicurezza sia adatta ai parametri di ingresso di sicurezza intrinseca dell'apparecchiatura LR200 occorre eseguire il seguente calcolo:

- R_{e-e} = massima resistenza della barriera, tra i due estremi
 R_{loop} = resistenza del loop (somma della resistenza del cavo + resistenza di misura, indicatori/display e/o ingressi PLC)
 $V_{barrier}$ = valore di qualsiasi caduta di tensione non lineare provocata dalla barriera

- 1) Definire il valore R_{e-e} in base alla scheda tecnica.
- 2) Calcolare il valore totale di R_{loop} : sommando, ad esempio, resistenza di misura, display e/o ingressi PLC.
- 3) Calcolare $R_{working} = R_{e-e} + R_{loop}$.

- 4) Definire il valore V_{barrier} in base alla scheda tecnica della barriera (esempio: caduta di tensione dovuta ai diodi).
- 5) Calcolare $V_{\text{working}} = V_{\text{supply}} - V_{\text{barrier}}$.

Utilizzare i valori V_{working} e R_{working} per confermare che l'apparecchiatura funziona in conformità con la parte grigia del grafico *Curva 1 (Uso generale, intrinsecamente sicuro, non incendiario)* pagina 23.

Note:

- Il seguente elenco non è tassativo: Vi sono diverse fonti e barriere intrinsecamente sicure adatte per il LR200.
- I moduli di ingresso PLC e le barriere sottoindicate sono stati testati e risultano funzionalmente compatibili con il LR200.

Barriere attive (barriere di ripetizione)

Marca, fabbricante	Numero pezzo
MTL	706
MTL	7206
Stahl	9001/51-280-110-14
Pepperl+Fuchs	KSD2-CI-S-Ex
Pepperl+Fuchs	KFD2-STC3-Ex1
MTL	E02009 - controllare
MTL	E02010

Istruzioni specifiche per zone potenzialmente esplosive (Direttiva Europea ATEX 94/9/CE, Allegato II, 1/0/6)

Le istruzioni che seguono riguardano apparecchiature contrassegnate dal numero di certificato SIRA 06ATEX2378X, SIRA 05ATEX1001X:

- 1) Per l'uso e l'assemblaggio, fare riferimento al manuale d'uso integrale.
- 2) L'apparecchiatura è certificata per l'uso come dispositivo di Categoria 1G.
- 3) L'apparecchiatura può essere utilizzata in atmosfere potenzialmente esplosive composte da gas o vapori pericolosi, con dispositivi del Gruppo IIC, IIB e IIA, classi di temperatura T1, T2, T3 e T4.
- 4) Questa apparecchiatura è adatta per l'uso a temperature ambienti comprese tra -40 °C e $+80\text{ °C}$.
- 5) Questa apparecchiatura non è stata definita dispositivo di sicurezza nell'ambito della direttiva 94/9/CE Allegato II, clausola 1,5.
- 6) L'installazione e l'ispezione di questi dispositivi devono essere eseguite da personale qualificato in conformità con le normative locali correnti (EN 60079-14 e EN 60079-17 in Europa).

- 7) L'apparecchiatura non può essere riparata.
- 8) Il suffisso 'X' del numero di certificato si riferisce a condizioni speciali per l'uso sicuro. Il personale responsabile dell'installazione e dell'ispezione dell'apparecchio deve poter accedere ai certificati.
- 9) Se esiste la possibilità che l'apparecchio entri in contatto con sostanze aggressive, l'utente è responsabile ed è tenuto a prendere le debite precauzioni in modo da evitare che essa venga danneggiata, assicurandosi pertanto che non venga compromesso il tipo di protezione.

Esempi di sostanze aggressive: liquidi o gas acidi in grado di attaccare e corrodere metalli, o solventi in grado di danneggiare materiali polimerici.

Precauzioni adeguate: come ad esempio, consultazione delle specifiche dei materiali relative alla resistenza a sostanze chimiche specifiche.

Attivazione del SITRANS LR200

Collegare l'alimentazione. SITRANS LR200 si avvia automaticamente nel modo di Misura. (Per modificare la lingua visualizzata vedi *Selezione di un'opzione (esempio: selezione della lingua)* pagina 17.)

Indicatore LCD

Modo di misura (funzionamento normale)

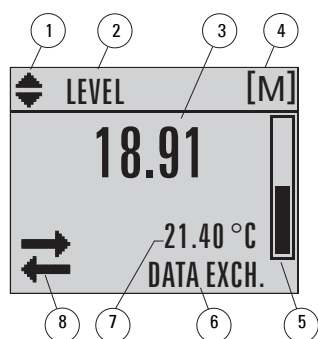

- 1 – indicatore di commutazione unità lineari/ %
- 2 – modo di funz. impostato: livello, spazio o distanza
- 3 – valore misurato (livello o volume, spazio o distanza)
- 4 – unità
- 5 – indicazione grafico a barre: livello
- 6 – l'altra zona del display indica (su richiesta)¹⁾ la temperatura dell'elettronica, l'attendibilità dell'eco, la corrente del loop o la distanza
- 7 – zona di testo, indica messaggi di stato
- 8 – indicatore di stato dell'apparecchiatura

Presenza guasto



S: 0 LOE

- 7 – zona di testo, indica un codice di errore sotto forma di un messaggio
- 8 – icona indica che l'apparecchio necessita di manutenzione

Modo PROGRAM

Visualizzazione durante la navigazione

- Se la barra di menù è visibile significa che la lista di menù è troppo lunga e non è possibile visualizzare tutti gli item.

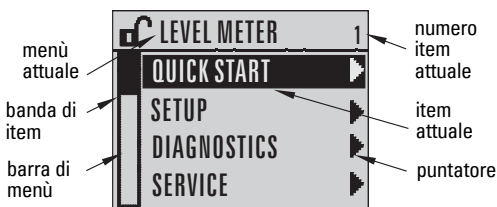

¹⁾ Se viene premuto in tasto: vedi *Principali funzioni, modo di misura* pagina 15.

Visualizzazione parametri

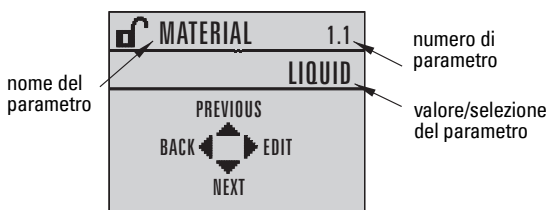

Modo editazione

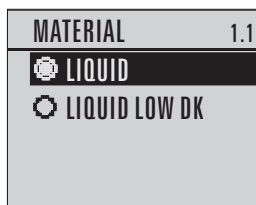

- Il numero di item tra cui scegliere dipende dalla larghezza della barretta nella barra di scorrimento.

Programmatore portatile





(Numero pezzo 7ML1930-1BK)

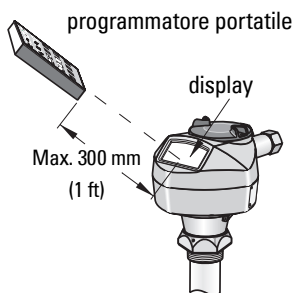



Il programmatore deve essere ordinato separatamente.

- Puntare il programmatore verso il display (distanza max. 300 mm [1 ft.]).
- Premere  Mode per passare dal modo di Misura al modo PROGRAM.



Principali funzioni, modo di misura

Tasto	Funzione	Risultato
	Con Mode si accede al modo PROGRAM.	Apri l'ultimo livello di menù visualizzato durante l'attuale sequenza di funzionamento, o il menù livello 1 se l'alimentazione è stata riattivata una volta chiuso il modo PROGRAM o se sono trascorsi più di 10 minuti dalla chiusura del modo PROGRAM.
	Freccia DESTRA si accede al modo PROGRAM.	Accede al menù livello 1.
 	Freccia ALTO o BASSO commutazione unità lineari / percentuale.	L'indicatore LCD visualizza il valore misurato in unità lineari o percentuale.

Tasto	Funzione	Risultato
	Aggiorna la corrente del loop.	La zona secondaria dell'indicatore LCD visualizza un valore nuovo.
	Aggiorna il valore di temperatura (interno custodia).	
	Aggiorna il valore di attendibilità dell'eco.	
	Aggiorna la misura di distanza.	

Programmazione del SITRANS LR200

Nota: SITRANS LR200 torna automaticamente al modo di misura dopo un periodo di inattività nel modo PROGRAM (tra 15 secondi e 10 minuti a seconda del livello di menù).

Le diverse impostazioni dell'apparecchiatura possono essere modificate localmente con l'interfaccia locale o a distanza con SIMATIC PDM. L'interfaccia locale (LUI, Local User Interface) è composta da un indicatore LCD e un programmatore portatile.

- Consultare *Accesso all'assistente di avvio rapido con il programmatore portatile* pagina 18.
- Vedi *Accesso all'assistente di avvio rapido con SIMATIC PDM* pagina 21.

Menù di parametri

Nota: Per una lista completa di parametri con le relative istruzioni vedi il manuale d'uso integrale. La lista è scaricabile dalla pagina Prodotto del nostro sito internet: www.siemens.com/LR200.

I parametri sono identificati per nome, divisi in gruppi di funzioni e disposti in una struttura di menù a 5 livelli.

1. QUICK START
2. SETUP
3. DIAGNOSTICS
 - 3.14. MEAS. VALUES
 - 3.14.1. CURR. INTERN. TEMP.

Accesso a parametri tramite il programmatore portatile

1. Attivare il modo PROGRAM



- a) Puntare il programmatore verso il display (distanza max. 300 mm [1 ft]).
- b) Premere la **freccia DESTRA**  per accedere al menù livello 1.

2. Navigazione: principali funzioni, modo navigazione

Tasto	Nome	Livello menù	Funzione
 	Freccia ALTO o BASSO	menù o parametro	• Passare al menù o parametro precedente/ successivo.
	Freccia DESTRA	menù	• Accedere al primo parametro del menù selezionato
		parametro	• Accedere al modo Editazione .
	Freccia SINISTRA	menù o parametro	• Accedere al menù genitore.
	Modo	menù o parametro	• Passare al modo di MISURA .
	Home	menù o parametro	• Accede al menù livello 1.

3. Editazione in modo PROGRAM

Selezione di un'opzione (esempio: selezione della lingua)

- Accedere a **Lingua (7)**.
- Premere la **freccia DESTRA**  per visualizzare il parametro.
- Premere nuovamente la **freccia DESTRA**  per accedere al modo **Editazione**. La selezione attuale è evidenziata.

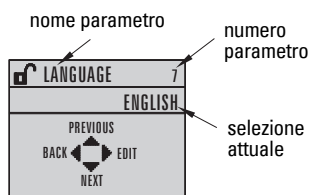

- Accedere a una selezione nuova.
Premere la **freccia DESTRA**  per confermare. L'indicatore LCD visualizza la nuova selezione.

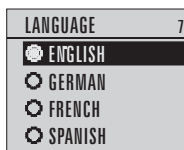



- Premere la **freccia SINISTRA**  per accedere nuovamente al menù.

Modificazione di un valore numerico

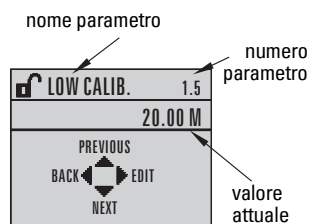
- Accedere al parametro desiderato.
- Premere la **freccia DESTRA**  per visualizzare il parametro. Viene visualizzato in valore attuale.





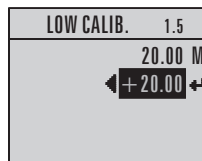

- c) Premere nuovamente la **freccia**  per accedere al modo **Editazione**. Il valore attuale è evidenziato.
- d) Digitare il valore scelto e premere la **freccia**  per confermare.

L'indicatore LCD visualizza la nuova selezione.





Principali funzioni, modo editazione

Tasto	Nome	Funzione	
	Freccia ALTO o BASSO	Selezione di opzioni	<ul style="list-style-type: none"> Accede all'item.
		Editazione numerica	<ul style="list-style-type: none"> Aumenta o riduce le cifre Passa dal più al meno
	Freccia DESTRA	Selezione di opzioni	<ul style="list-style-type: none"> Conferma i dati (accede al parametro in scrittura) Passa dal modo Editazione al modo Navigazione
		Editazione numerica	<ul style="list-style-type: none"> Sposta il cursore un posto verso destra o con il cursore posizionato su Enter, conferma i dati e passa dal modo Editazione al modo Navigazione
	Freccia SINISTRA	Selezione di opzioni	<ul style="list-style-type: none"> Annulla il modo Editazione senza modificare il parametro
		Editazione numerica	<ul style="list-style-type: none"> Sposta il cursore sul più/meno se si tratta del primo tasto premuto o sposta il cursore un posto verso sinistra.
	Cancel-lare	Editazione numerica	<ul style="list-style-type: none"> Cancel-la il display.
	Virgola decimale	Editazione numerica	<ul style="list-style-type: none"> Immette una virgola decimale.
	Segno +/-	Editazione numerica	<ul style="list-style-type: none"> Cambia il segno del valore impostato.
	Numerico	Editazione numerica	<ul style="list-style-type: none"> Immette il carattere corrispondente.

Accesso all'assistente di avvio rapido con il programmatore portatile

Nota: L'attivazione dell'Assistente di avvio rapido ripristina i valori preimpostati. L'Assistente non dà la possibilità di applicare i valori impostati dall'utente.

1. Avvio rapido

- a) Puntare il programmatore verso il display (a una distanza massima di 300 mm [1 ft.]), e premere la **freccia DESTRA**  per attivare il modo PROGRAM e accedere al menù livello 1.
- b) Premere la **freccia DESTRA**  due volte per accedere all'item menù 1.1 e visualizzare i parametri.

- c) Premere la freccia **DESTRA** ➡ per accedere al modo **Editazione** o la freccia **BASSO** ▼ per confermare i valori preimpostati ed accedere direttamente all'item successivo.
- d) Per modificare un valore impostato accedere all'item desiderato o digitare un valore nuovo.
- e) Per confermare un valore nuovo, premere la freccia **DESTRA** ➡ e la freccia **BASSO** ▼ per accedere all'item successivo.
- f) Per memorizzare i valori impostati durante l'Avvio Rapido è necessario selezionare **Yes/Sì** in risposta alla domanda **Apply changes (Confermare modifiche)**, tappa 1.7).

1.1. Materiale

Opzioni	LIQUID
	LIQUID LOW DK (liquido a basso dielettrico)

1.2. Velocità di risposta

Regola la risposta di misurazione dell'apparecchio all'interno della portata.

Opzioni	SLOW (lenta)	0.1 m/minuto
	MED (media)	1.0 m/minuto
	FAST (veloce)	10.0 m/minuto

Impostare un valore leggermente superiore alla massima velocità di riempimento o svuotamento (a seconda del valore piu' alto).

1.3. Unità sensore

Selezionare le unità per le variabili di Avvio Rapido (punto di calibrazione alto/basso, livello, distanza, spazio)

Opzioni	M, CM, MM, FT, IN
----------------	-------------------

1.4. Funzionamento

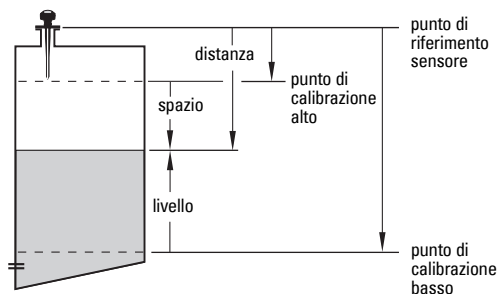

Modo di funzionamento	NO SERVICE	SITRANS LR200 non aggiorna più le misura e la relativa corrente di loop. Indicazione dell'ultima misura valida.
	LEVEL (Livello)	Distanza alla superficie del prodotto, misurata a partire dal punto di calibrazione basso (livello processo vuoto).
	SPACE (Spazio)	Distanza alla superficie del prodotto, misurata a partire dal punto di calibrazione alto (livello processo pieno).
	DISTANCE (Distanza)	Distanza alla superficie del prodotto, misurata a partire dal punto di riferimento del sensore.

1.5. Punto di calibrazione basso

Distanza tra il punto di riferimento sensore e il punto di calibrazione basso: generalmente livello processo vuoto.

Valori	Portata: 0.0000 - 20.000 m
---------------	----------------------------

1.6. Punto di calibrazione alto

Distanza tra il punto di riferimento sensore e il punto di calibrazione alto: generalmente il livello processo pieno.

Valori	Portata: 0.0000 - 20.000 m
---------------	----------------------------

1.7. Confermare modifiche ?





Per memorizzare i valori impostati (avvio rapido) è necessario selezionare **Yes/Sì** per applicare le modifiche.

Opzioni	YES, NO
----------------	---------

Il display visualizza **DONE** una volta concluso l'avvio rapido.

Premere **Mode**  per accedere nuovamente al modo Misura (RUN). Il SITRANS LR200 è pronto per l'uso.

Richiesta profilo dell'eco

- 1) in modo PROGRAM, accedere a: **Level Meter (Misuratore di livello) > Diagnostics (Diagnostica) (3) > Profilo dell'eco (3.1)**.
- 2) Premere la **freccia DESTRA** .
- 3) Nella finestra Profilo, premere la **freccia ALTO**  per selezionare l'icona **Transmit (Trasmissione)**, e la **freccia DESTRA**  per aggiornare il profilo.
- 4) Premere la **freccia BASSO**  per selezionare l'icona **Exit (Uscita)**, e la **freccia DESTRA**  per accedere al menù precedente.

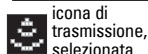
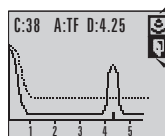
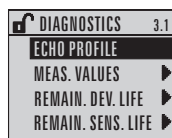

icona di trasmissione, deselegionata

icona di uscita, selezionata

Comunicazione SITRANS LR200: HART

- Per ottenere la lista di tutti i parametri è necessario consultare il manuale completo.
- Si consiglia di utilizzare SIMATIC Process Device Manager (PDM) per programmare l'apparecchiatura.

SIMATIC PDM

Note:

- Si consiglia di utilizzare SIMATIC PDM V 6.0 SP3 (o versione ulteriore).
- SIMATIC PDM V 5.2 SP1 è utilizzabile soltanto per la configurazione di base e la ricerca guasti. Le funzioni avanzate quali l'Assistente di avvio rapido richiedono la versione 6.0 SP3 (o una versione ulteriore).

SIMATIC PDM è un pacchetto software per la messa in servizio e la manutenzione del SITRANS LR200 e di altre apparecchiature da campo. Per ulteriori informazioni sur SIMATIC PDM si prega di consultare le istruzioni d'uso o l'aiuto in linea (online help). (Per ulteriori informazioni sul software potete consultare www.fielddevices.com: rubrica **Products and Solutions > Products and Systems > Communications and Software > Process Device Manager**).

Electronic Device Description (EDD)

- Il file può essere scaricato dalla rubrica Device Catalog, pagina **Sensors/Level/Echo/Siemens Milltronics/SITRANS LR200**.
- Consultare la pagina Prodotto sul nostro sito internet: www.siemens.com/LR200, rubrica **Downloads**, per ottenere l'ultima versione di SIMATIC PDM, del Service Pack (SP) e del hotfix (HF). Per installare un nuovo file EDD, vedi *Impostazione di una seconda apparecchiatura* nelle pagine seguenti.

Impostazione di una seconda apparecchiatura

Nota: Cliccando su **Cancel** durante il telecaricamento dall'apparecchiatura a SIMATIC PDM si ottiene l'aggiornamento di alcuni parametri.

1. È importante disporre dell'ultima versione del file EDD, che può essere scaricato dalla pagina Prodotto sopra indicata. I file devono essere memorizzati sul computer dell'utente. Estrarre il file zip assicurandosi che sia facilmente accessibile. Avviare **SIMATIC PDM – Manager Device Catalog**, accedere al file EDD dezipato e selezionarlo.
2. Avviare SIMATIC PDM e creare un progetto nuovo per il LR200. Le note esplicative per l'impostazione di apparecchiature HART con SIMATIC PDM sono scaricabili dalla pagina Prodotto del nostro sito: www.siemens.com/LR200.
3. Telecaricare i parametri al PC/PG.
4. Calibrare l'apparecchio con l'assistente di avvio rapido (vedi di seguito).

Accesso all'assistente di avvio rapido con SIMATIC PDM

Note:

- Esiste una correlazione tra le diverse impostazioni. Le modifiche vengono applicate cliccando **Trasfer (Trasferire)** dopo la tappa 5.
- L'attivazione dell'Assistente di avvio rapido ripristina i valori preimpostati. L'Assistente non dà la possibilità di applicare i valori impostati dall'utente.
- Cliccare su **BACK (Precedente)** per correggere un'impostazione o **Cancel (Cancellare)** per uscire dal programma di Avvio rapido.

Attivare SIMATIC PDM, accedere al menù **Device – Quick Start**, e seguire le tappe 1 - 5.

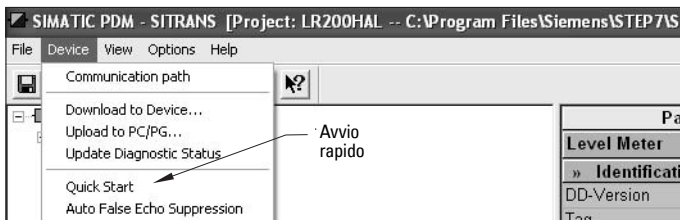

Manutenzione

SITRANS LR200 non richiede interventi di manutenzione o pulizia in condizioni operative normali. In condizioni operative particolari può essere necessario pulire il misuratore di livello.

1. Procedere alla pulizia dell'apparecchio tenendo conto dei materiali utilizzati per l'antenna e del materiale all'interno del serbatoio.
2. Rimuovere l'apparecchio e pulire l'antenna con un panno e una soluzione detergente appropriata.

Riparazione dell'apparecchio ed esclusione di responsabilità

Per ulteriori informazioni consultare la copertina finale di questo manuale.

Grafico della temperatura massima di lavoro

ATTENZIONE: La temperatura interna non deve eccedere 80 °C (176 °F).

Massima temperatura flangia e processo versus temperatura ambiente permessa per strumenti SITRANS LR200 con adattatore a flangia

- Il grafico è fornito a scopo informativo.
- Non tutti i tipi di attacchi di processo sono rappresentati. Ad es. il grafico NON può servire da riferimento se l'apparecchiatura SITRANS LR200 va installata direttamente su una superficie metallica del serbatoio.
- Non si tiene conto del calore legato all'esposizione diretta al sole.
- Il parametro 3.14.1 consente di controllare la temperatura interna.

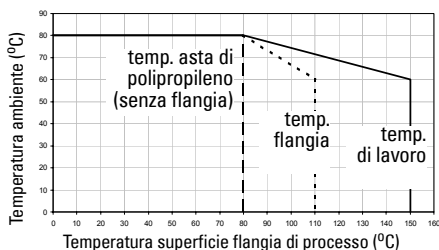

Alimentazione del loop

Collegamento tipico

Nota: La tensione del loop viene misurata ai terminali dell'alimentazione (non ai terminali dell'apparecchiatura).

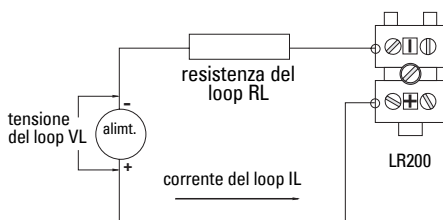

Zona di impiego autorizzata

Curva 1 (Uso generale, intrinsecamente sicuro, non incendiario)

Tensione del loop vs. Resistenza del loop

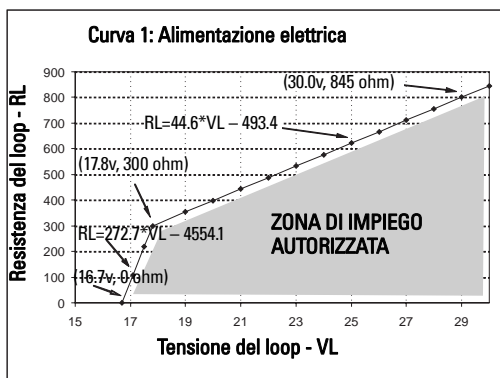

Curva 2 (Antideflagrante, sicurezza aumentata, a prova di esplosione)

Tensione del loop vs. Resistenza del loop

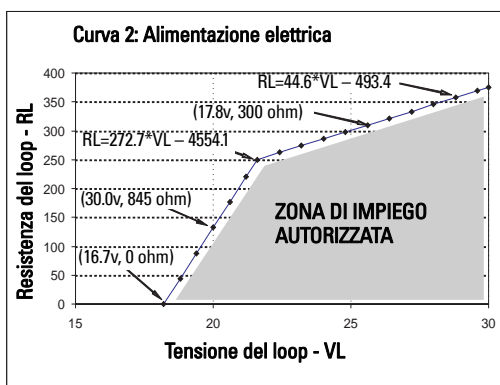

Curva di messa in servizio

Nota: Dopo la messa in servizio l'apparecchio richiede 25/55 secondi prima di indicare il livello del materiale.

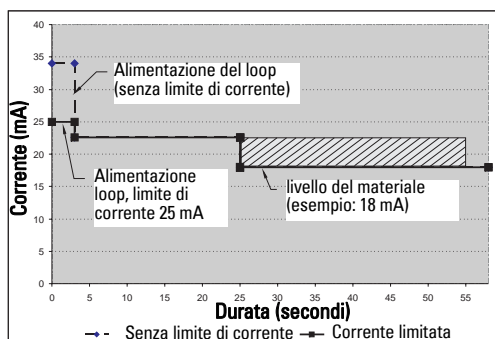

Nota

SITRANS LR200 (HART) met Siemens LUI Interface: Quick Start Handleiding

Deze handleiding beschrijft de essentiële kenmerken en functies van de SITRANS LR200 (HART). Wij raden u sterk aan de uitgebreide versie van de handleiding aan te schaffen zodat u uw instrument zo optimaal mogelijk kunt gebruiken. De volledige handleiding kan worden gedownload van de SITRANS LR200 productpagina of via onze website: www.siemens.com/LR200. De gedrukte handleiding is verkrijgbaar bij uw lokale Siemens Milltronics vertegenwoordiging.

Vragen omtrent de inhoud van deze handleiding kunnen worden gericht aan:

Siemens Milltronics Process Instruments Inc.
1954 Technology Drive, P.O. Box 4225
Peterborough, Ontario, Canada, K9J 7B1
Email: techpubs.smpi@siemens.com

**Auteursrecht Siemens Milltronics
Process Instruments Inc. 2008.
Alle rechten voorbehouden**

Disclaimer

Wij raden gebruikers aan geautoriseerde, ingebonden gebruikershandleidingen te kopen, of om de elektronische versies te raadplegen, zoals ontworpen en goedgekeurd door Siemens Milltronics Process Instruments Inc. Siemens Milltronics Process Instruments Inc. is niet aansprakelijk voor de inhoud van gedeeltelijk, of geheel gekopieerde versies, gebonden of elektronisch.

Hoewel we de inhoud van deze gebruikershandleiding hebben geverifieerd aan de omschreven instrumentatie, kunnen desondanks afwijkingen voorkomen. Wij kunnen derhalve niet een volledige overeenstemming garanderen. De inhoud van deze handleiding wordt regelmatig herzien, en correcties worden opgenomen in volgende uitgaven. Wij houden ons aanbevolen voor suggesties ter verbetering. Technische gegevens kunnen worden gewijzigd.

MILLTRONICS is een geregistreerd handelsmerk van Siemens Milltronics Process Instruments Inc.

Technische ondersteuning

Ondersteuning is 24-uur per dag beschikbaar.

Ga naar de hierna vermelde website om het adres, telefoonnummer en faxnummer van uw lokale Siemens Automation kantoor te vinden:

www.siemens.com/automation/partner:

- Klik op het tabblad **Contacts by product** en zoek dan uw productgroep (**+Process Automation > +Process Instrumentation > +Level Measuring Instruments**).
- Selecteer het team **Technische ondersteuning**. Klik op **Next**.
- Klik op een continent, dan een country (land), gevolgd door een city (plaats). Klik op **Next**.

Ga voor on-line technische ondersteuning naar: www.siemens.com/automation/support-request

- Voer de naam van het apparaat in (SITRANS LR200) of het bestelnummer, klik vervolgens op **Search**, en selecteer het juiste producttype. Klik op **Next**.
- Voer een sleutelwoord in dat uw vraag omschrijft. Blader vervolgens door de relevante documentatie, of klik op **Next** om een omschrijving van uw vraag op te sturen naar het technische ondersteuningspersoneel van Siemens.

Siemens A&D Technical Support Center:

telefoon +49 180 50 50 222

Veiligheidsrichtlijnen

Waarschuwingmeldingen moeten worden aangehouden om de eigen veiligheid en die van anderen te waarborgen en om het product en de aangesloten apparatuur te beschermen. Deze waarschuwingmeldingen gaan vergezeld met een verduidelijking van de mate van voorzichtigheid die moet worden aangehouden.



Waarschuwing: Heeft betrekking op een waarschuwingssymbool op het product en betekent dat het niet aanhouden van de noodzakelijke voorzorgsmaatregelen kan leiden tot ernstig of dodelijk letsel en/of aanzienlijke materiële schade.



WAARSCHUWING¹⁾: betekent dat het niet aanhouden van de noodzakelijke voorzorgsmaatregelen kan leiden tot ernstig of dodelijk letsel en/of aanzienlijke materiële schade

Opmerking: geeft belangrijke informatie aan over het product of dat deel van de gebruikershandleiding.

FCC conformiteit

Alleen voor US installaties: Federal Communications Commission (FCC) regelgeving



Waarschuwing: Wijzigingen of modificaties die niet uitdrukkelijk zijn goedgekeurd door Siemens Milltronics kunnen de toestemming om de apparatuur te bedienen ongeldig maken.

Opmerkingen:

- Deze apparatuur is getest, en voldoet aan de grenswaarden voor een Class A digital device, zoals vastgelegd in Part 15 van de FCC regelgeving. Deze grenswaarden zijn vastgelegd voor het bieden van een redelijke bescherming tegen schadelijke interferentie wanneer de apparatuur wordt gebruikt in een commerciële omgeving.
- Deze apparatuur genereert, gebruikt en kan radiofrequentie-energie uitzenden en kan, indien niet gebruikt en geïnstalleerd conform de gebruikershandleiding schadelijke interferentie veroorzaken voor radiocommunicatie. Gebruik van deze apparatuur in woonomgevingen zal hoogstwaarschijnlijk leiden tot schadelijke interferentie voor radiocommunicatie. In dat geval moet de gebruiker de interferentie voor eigen rekening corrigeren.

SITRANS LR200



Waarschuwing: De SITRANS LR200 mag uitsluitend worden gebruikt op de manier zoals beschreven in deze handleiding, anders kan de bescherming die deze apparatuur biedt in gevaar komen.

Opmerking: Dit product is bedoeld voor gebruik in industriegebieden. Bij gebruik in woongebieden kunnen er storingen van verschillende radiografische toepassingen ontstaan.

SITRANS LR200 is een 2-draads, 6 GHz pulsradar niveautransmitter voor continue bewaking van vloeistoffen en slurries in opslagtanks, waaronder hogedruk- en hogetemperatuur-configuraties, tot een bereik van 20 m (66ft).

¹⁾ Dit symbool wordt gebruikt wanneer er geen corresponderend waarschuwingssymbool op het product aanwezig is.

Het apparaat bestaat uit een elektronicaschakeling gekoppeld aan de antenne en een schroefdraad- of flens procesaansluiting.

Communicatie vindt plaats via HART¹⁾. Signalen worden verwerkt m.b.v. Process Intelligence.

Specificaties

Raadpleeg voor een compleet overzicht de SITRANS LR200 (HART) gebruikershandleiding. Raadpleeg voor informatie over toelatingen het typeplaatje van het instrument en het proces typeplaatje.

Omgevings-/bedrijfstemperatuur

Opmerkingen:

- Procestemperatuur en drukspecificaties zijn afhankelijk van informatie op het typeplaatje van het procesinstrument. De referentietekening die is vermeld op de tag kan worden gedownload van de Siemens website: www.siemens.com/LR200.
- De maximale temperatuur is afhankelijk van de procesaansluiting, antennematerialen en tankdruk. Zie *Maximum procestemperatuurgrafiek* op pagina 22, voor meer informatie. Procestdruktemperatuurcorrectiegrafieken kunt u vinden in de uitgebreide handleiding.

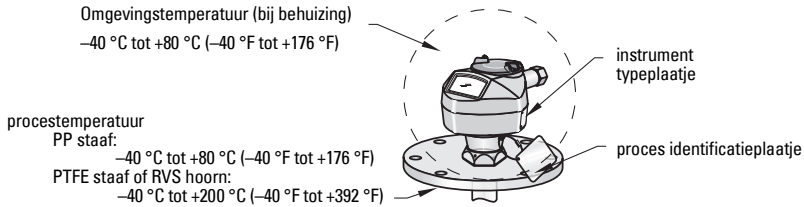

Voeding



General Purpose:

Niet brandveroorzakend (alleen FM/US):

Intrinsiek veilig:



Vlambestendig:

Verhoogde veiligheid:

Explosie veilig (alleen FM/CSA US/Canada):

Nominaal 24 V DC bij

max. 550 Ohm

lusweerstand.

Nominaal 24 V DC bij

max. 250 Ohm

lusweerstand.

Goedkeuringen

- Algemeen CSA_{US/C}, FM, CE
- Radio Europa (R&TTE), FCC, Industry Canada

(vervolgd op volgende pagina)

¹⁾ HART[®] is een geregistreerd handelsmerk van de HART Communications Foundation.

- Explosiegevaarlijk

Vlambestendig (Europa)¹⁾

Verhoogde veiligheid (Europa)²⁾

Explosie veilig (USA/Canada)³⁾

ATEX II 1/2 G, EEx dm ia IIC T4

ATEX II 1/2 G, EEx em ia IIC T4

FM/CSA: (Zenerbarrière niet vereist)

Class I, Div. 1, Groups A, B, C, D

Class II, Div. 1, Groups E, F, G

Class III T4

Opmerking: Gebruik de juiste doorvoerafdichtingen om de IP- of NEMA-beschermingsklasse te handhaven.

Toelatingen (vervolg)

- Explosiegevaarlijk

Niet brandveroorzakend (US)⁴⁾

FM: (Zenerbarrière niet vereist)

Class I, Div. 2, Groups A, B, C, DT5

Intrinsiek veilig⁵⁾

(Europa)

ATEX II 1 G, EEx ia IIC T4

(US/Canada)

FM/CSA: (Zenerbarrière vereist)

Class I, Div. 1, Groups A, B, C, D

Class II, Div. 1, Groups E, F, G

Class III T4

(Australië)

ANZEX Ex ia IIC T4

(Tomg = -40 tot +80 °C) IP67

(Internationaal)

IECEX TSA 04.0020X T4

- Scheepvaart Lloyd's Register of Shipping

ABS typegoedkeuring

Programmeereenheid (infrarood toetsenbord)

Siemens Milltronics infrarood IS (Intrinsically Safe) handprogrammeereenheid voor gevaarlijke en alle andere locaties (batterij kan niet worden vervangen en heeft een levensduur van 10 jaar bij normaal gebruik).

- goedkeuring ATEX II 1 G, EEx ia IIC T4, certificaat SIRA 01ATEX2147
FM/CSA: Class I, Div. 1, Groups A, B, C, D
- omgevingstemperatuur -20 tot 40 °C (-5 tot 104 °F)
- interface eigen infrarood pulssignaal
- voeding 3 V lithium batterij
- gewicht 150 g (0.3 lb)
- kleur zwart
- artikelnummer 7ML1930-1BK

¹⁾ Zie *Vlambestendige bekabeling* op pagina 9.

²⁾ Zie *Verhoogde veiligheid bekabeling* op pagina 10.

³⁾ Zie *Explosie veilige bekabeling (alleen FM/CSA US/Canada)* op pagina 10.

⁴⁾ Zie *Niet brandveroorzakende bekabeling (alleen FM/US)* op pagina 11.

⁵⁾ Zie *Intrinsiek veilige bekabeling* op pagina 11.

Druktoepassing



WAARSCHUWINGEN:

- Dit product is ontworpen als een druktoestel zoals vastgelegd in richtlijn 97 / 23 / EC, en is niet bedoeld voor gebruik als veiligheidsinrichting.
- Probeer nooit de procesaansluiting los te draaien, te verwijderen of te demonteren terwijl de tank onder druk staat.
- Onjuiste installatie kan leiden tot verlies aan procesdruk.

Installatie



WAARSCHUWINGEN:

- De installatie mag uitsluitend worden uitgevoerd door gekwalificeerd personeel en in overeenstemming met lokale regelgeving.
- Constructiematerialen zijn gekozen op basis van hun chemische compatibiliteit (of inerteheid) voor algemene doeleinden. Controleer voor blootstelling aan specifieke omgevingen, de chemische compatibiliteitstabellen voorafgaande aan de installatie.

Opmerkingen:

- Het processtijplaatje moet bij de procesdrukgrenseenheid blijven¹⁾. In geval dat deze eenheid wordt vervangen, moet het processtijplaatje worden overgebracht op de vervangende eenheid.
- SITRANS LR200 eenheden zijn hydrostatisch getest, waarbij (ruim) wordt voldaan aan de vereisten van de ASME "Boiler and Pressure Vessel" norm alsmede de Europese richtlijn voor drukapparatuur.

Installatierichtlijnen

- Zorg voor gemakkelijke toegang om het display te bekijken en voor programmering via de handprogrammeereenheid.
- Zorg voor een omgeving die geschikt is voor de beschermingsklasse van de behuizing en de gebruikte constructiematerialen.
- Zorg voor een zonnedak wanneer het instrument in direct zonlicht wordt opgesteld.

¹⁾ De proces drukgrenseenheid bestaat uit de componenten die fungeren als een barrière tegen drukverlies uit het procesvat: d.w.z. de combinatie van procesaansluiting huis en zender, maar normaal gesproken zonder de elektrische behuizing.

Hoornontwerp

Opmerkingen:

- Gebruik de 100 mm (4") afscherming op nozzles met een lengte van 100 mm (4") of minder.
- Gebruik de 250 mm (10") afscherming op nozzles met een lengte van 250 mm (10") of minder.
- Raadpleeg voor meer informatie over andere toepassingen de uitgebreide handleiding.

- Het uiteinde van het afgeschermd deel moet minimaal 10 mm (0.4") uitsteken om stoorecho's te voorkomen die door de hoorn worden gereflecteerd.

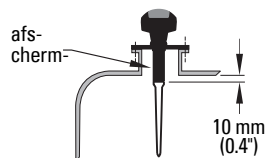

Locatie op een mangatdeksel

- Een mangatdeksel is typisch een afgedekte sok met een diameter van 610 mm (24") of groter.
- Plaats voor optimale signaalcondities de antenne uit het midden, typisch 100 mm (4") van de zijkant.

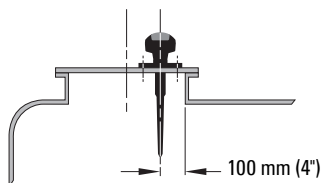

Locatie van de sok

! WAARSCHUWING: bij tanks met conische of parabolische bovenkant, het instrument niet in het midden plaatsen. (Door de concave bovenkant kunnen echo's in het midden worden gefocussiseerd, hetgeen kan leiden tot onjuiste meetwaarden.)

Opmerking: onder bepaalde omstandigheden kan het acceptabel zijn het instrument in het midden van een tank met vlakke bovenkant te installeren. Bespreek dit met uw lokale Siemens vertegenwoordiging.

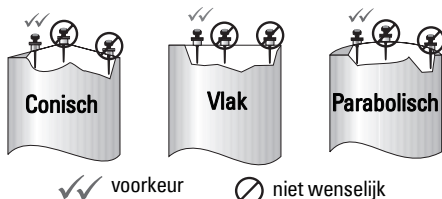

- Houd de zendconus interferentievrij door deze uit de buurt te monteren van ladders, leidingen, I-balken of vulstromen.
- Plaats de antenne niet bij de zijwand, om interferentie van indirecte echo's te voorkomen.
- Houd er rekening mee dat de zendconus uitspreid, om interferentie met tankwanden of obstructies te voorkomen.

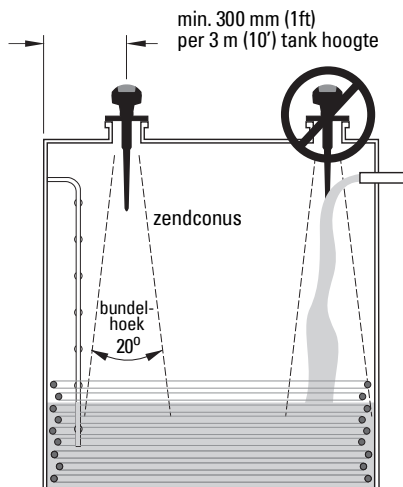

Installatie-instructies

Opmerkingen:

- Er is geen grens aan het aantal maal dat het instrument kan worden gedraaid.
- Richt de voorkant of achterkant van het apparaat naar de dichtstbijzijnde tankwand.
- Draai de behuizing niet na programmering en configuratie van het apparaat (een polariteitsverschuiving van de zendpuls kan resulteren in een fout).

Schroefdraaduitvoering

- 1) Controleer vóór het aanbrengen van het instrument in de montage-aansluiting of de schroefdraadaansluitingen van hetzelfde type zijn zodat ze niet beschadigd raken.
- 2) Schroef het apparaat in de procesaansluiting en draai dit handvast aan. Gebruik bij druktoepassingen PTFE tape of andere schroefdraadafdichtmiddel en draai de procesaansluiting strakker aan dan handvast (max. aandraaimoment 40 N·m (30 ft.lbs).
- 3) Draai om de behuizing te draaien, eerst de drie borgschroeven los waarmee de borgring is vastgemaakt. Draai na het positioneren van de behuizing de schroeven weer aan.

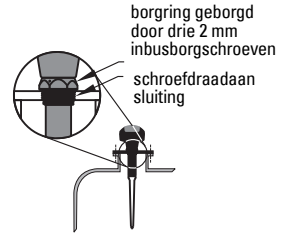

Flensuitvoering



Waarschuwing: De gebruiker is verantwoordelijk voor het kiezen van bevestigingsmateriaal en pakkingen die binnen de flensmaat vallen, voldoen aan het bedoelde gebruik en geschiktheid voor de bedrijfsomstandigheden.

Bedrading Voeding

WAARSCHUWINGEN:



De DC ingangsklemmen moeten worden gevoed uit een bron die galvanisch is gescheiden tussen in- en uitgang, teneinde te voldoen aan de geldende veiligheidsvereisten van IEC 61010-1.



Alle veldbekabeling moet zijn voorzien van een isolatie die geschikt is voor nominale spanningen.

Aansluiten SITRANS LR200



WAARSCHUWINGEN:

- Controleer het typeplaatje van het instrument en het processtypeplaatje, om de toelatingen te verifiëren.
- Gebruik de juiste doorvoerafdichtingen om de IP- of NEMA-beschermingsklasse te handhaven.
- Lees *Instructies speciaal voor installatie in explosiegevaarlijke zones*: op pagina 13.

Opmerkingen:

- Raadpleeg de uitgebreide gebruikershandleiding voor gedetailleerde instructies omtrent de bedrading.
- Gebruik twisted pair kabel: AWG 22 tot 14 (0,34 mm² tot 2,5 mm²).
- Er kunnen aparte kabels en doorvoeren nodig zijn om te voldoen aan de standaard instrumentatie-bekabelingsnormen of elektrische regelgeving.

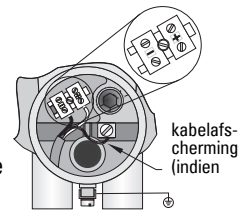
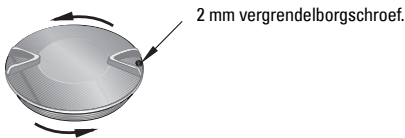

- 1) Gebruik een 2 mm inbussleutel om de borgschroef van de dekselvergrendeling los te draaien en draai vervolgens het deksel los.
- 2) Strip de kabelmantel over een lengte van ongeveer 70 mm (2.75") vanaf het einde van de kabel en voer de draden door de wartel..
- 3) Sluit de draden aan op de klemmen zoals weergegeven: de polariteit wordt aangegeven op het klemmenblok.
- 4) Aard het instrument conform de lokale regelgeving.
- 5) Draai de wartel aan om een goede afdichting te vormen.
- 6) Sluit het deksel en maak de borgring vast voordat u gaat programmeren en het apparaat gaat configureren. Draai het instrument niet na het configureren, omdat dit tot fouten kan leiden.

Aansluiten van HART: typische PLC/mA configuratie

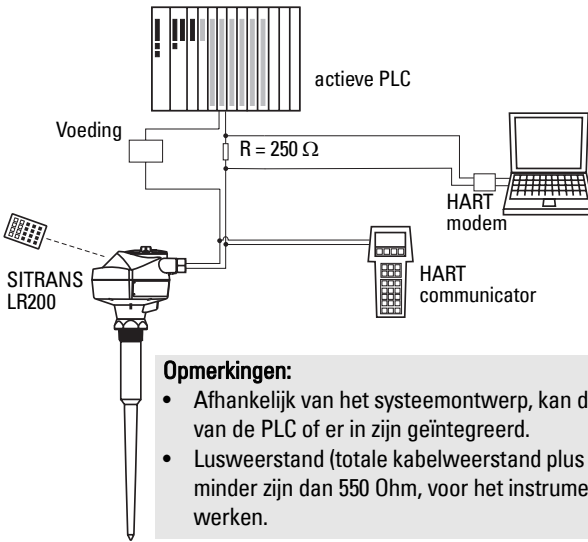

Opmerkingen:

- Afhankelijk van het systeemontwerp, kan de voeding zijn gescheiden van de PLC of er in zijn geïntegreerd.
- Lusweerstand (totale kabelweerstand plus 250 Ohm [weerstand]) moet minder zijn dan 550 Ohm, voor het instrument om goed te kunnen werken.

Bedrading configuraties voor installaties in explosiegevaarlijke gebieden

Opmerking: ATEX certificaten een aansluitschema's die hieronder zijn vermeld kunnen worden gedownload vanaf de productpagina van onze website: www.siemens.com/LR200.

Er zijn vijf bedradingsopties voor installaties in explosiegevaarlijke gebieden. Controleer in alle gevallen het typeplaatje van het instrument en het processtypeplaatje, om de toelatingen te verifiëren.





1. Vlambestendige bekabeling

SIEMENS		
SITRANS LR 200 7ML1234-56789-0ABC-D Serial No: GYZ / S1034567 Enc.: NEMA TYPE 4X, 6, IP67, IP68 Amb. Temp.: -40°C to 80°C Power Rating: 24V, ---, Norm., 30V, ---, Max., 4-20mA Siemens Milltronics Process Instruments Inc., Peterborough Made in Canada		
 II 1/2 G EEx dmbia IIC T4 SIRA 05ATEX1001X CE 0682 0518	HART Um = 250V	

Toelating	Geldig voor:	Referentie
ATEX II 1/2 G, EEx dm ia IIC T4	Europa	Flameproof/Increased Safety: ATEX Certificate op pagina A-1.

- Voor voedingsvereisten zie *Curve 2 (Vlambestendig, verhoogde veiligheid, explosie veilig)* op pagina 24.
- Hanteer de lokale regelgeving voor de bekabelingsvereisten.
- Zie ook *Instructies speciaal voor installatie in explosiegevaarlijke zones*: op pagina 13 en het hierboven vermelde ATEX certificaat.



2. Verhoogde veiligheid bekabeling

SIEMENS			
SITRANS LR200		 	II 1/2 G
7ML1234-56789-0ABC-D			EEx emia IIC T4
SerialNo: GYZ/S1034567			SIRA 05ATEX1001X
Encl.: NEMA/TYPEx 4X, 6, IP67, IP68			0682
Amb. Temp.: -40°C to 80°C			0518
Power Rating: 24V --- Nom. 30V --- Max. 4-20mA			
Siemens Milltronics Process Instruments Inc., Peterborough		 HART	
Made in Canada		Um = 250V	

Toelating	Geldig voor:	Referentie
ATEX II 1/2 G, EEx em ia IIC T4	Europa	<i>Flameproof/Increased Safety: ATEX Certificate</i> op pagina A-1.

- Voor voedingsvereisten zie *Curve 2 (Vlambestendig, verhoogde veiligheid, explosie veilig)* op pagina 24.
- Hanteer de lokale regelgeving voor de bekabelingsvereisten.
- Zie ook *Instructies speciaal voor installatie in explosiegevaarlijke zones*: op pagina 13 en het hierboven vermelde ATEX certificaat.

3. Explosie veilige bekabeling (alleen FM/CSA US/Canada)

SIEMENS			
SITRANS LR200		 	FCC ID: NJA-LR 200
7ML1234-56789-0ABC-D			CANADA: 267P-LR 200
SerialNo: GYZ/S1034567			HART
Encl.: NEMA/TYPEx 4X, 6, IP67, IP68			
Amb. Temp.: -40°C to 80°C			159134
Power Rating: 24V --- Nom. 30V --- Max. 4-20mA			
Siemens Milltronics Process Instruments Inc., Peterborough		WARNING: Do Not Remove Cover While Circuits Are Live	
Made in Canada			

Toelating	Geldig voor:	Referentie
FM/CSA: Class I, Div. 1, Groups A, B, C, D Class II, Div. 1, Groups E, F, G Klasse III T4	US/Canada	FM/CSA explosie veilige aansluiting tekeningnummer 23650597

- Voor voedingsvereisten zie *Curve 2 (Vlambestendig, verhoogde veiligheid, explosie veilig)* op pagina 24.
- Raadpleeg voor bekabelingsvereisten (alleen Noord-America) het hierboven vermelde aansluitschema, dat kan worden gedownload van de productpagina van onze website: www.siemens.com/LR200.

4. Niet brandveroorzakende bekabeling (alleen FM/US)

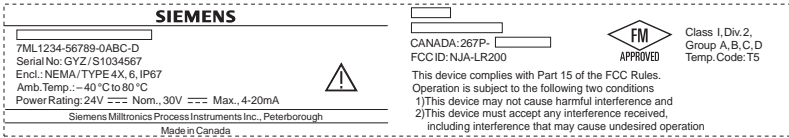

Toelating	Geldig voor:	Referentie
FM: Class I, Div. 2, Groups A, B, C, D T5	US	FM Niet brandveroorzakende aansluiting tekeningnummer 23650537

- Voor voedingsvereisten, zie *Curve 1 (General Purpose, intrinsiekveilig, niet-ontstekend)* op pagina 24.
- Raadpleeg voor bekabelingsvereisten (alleen Noord-America) het hierboven vermelde aansluitschema, dat kan worden gedownload van de productpagina van onze website: www.siemens.com/LR200.

5. Intrinsiekveilige bekabeling

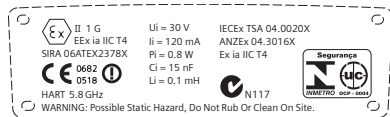
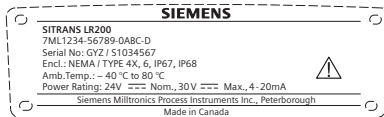
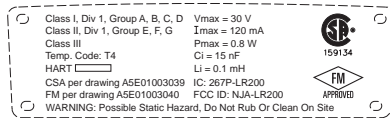
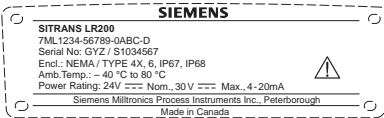

Toelating	Geldig voor:	Referentie
FM/CSA: Class I, Div. 1, Groups A, B, C, D Class II, Div. 1, Groups E, F, G Class III	US/Canada	FM intrinsiekveilige aansluiting tekeningnummer A5E01003040 CSA intrinsiekveilige aansluiting tekeningnummer A5E01003039
ATEX II 1 G, EEx ia IIC T4	Europa	<i>Intrinsically Safe: ATEX Certificate</i> op pagina A-5
ANZEX Ex ia IIC T4 (Tomg = -40 tot 80 °C) IP67	Australië	
IECEX TSA 04.0020X	Internationaal	

- Voor voedingsvereisten zie *Curve 1 (General Purpose, intrinsiekveilig, niet-ontstekend)* op pagina 24.

- Voor bedradingsvereisten:
 - Noord Amerika: Raadpleeg de hierboven vermelde aansluitschema's, welke gedownload kunnen worden via de productpagina van onze website: www.siemens.com/LR200.
 - Europa: Volg de lokale regelgeving.
 - Australië: Volg de lokale regelgeving.
 - Internationaal: Volg de lokale regelgeving.
- Gebruik de juiste doorvoerafdichtingen om de IP- of NEMA-beschermingsklasse te handhaven.
- Aanbevolen intrinsiekveilige barrières worden vermeld onder *Passieve shunt-diode barrières* op pagina 12.
- Raadpleeg *Instructies speciaal voor installatie in explosiegevaarlijke zones*: op pagina 13 en het hierboven vermelde ATEX certificaat.

Opmerking: Voor de keuze van een geschikte PLC ingangsmodule, voeding of barrière is kennis vereist van intrinsieke veiligheid en de toepassing. Het is de verantwoordelijkheid van de installateur om er voor te zorgen dat de intrinsiekveilige installatie voldoet aan zowel de toelatingsvereisten van het apparaat als de geldende landelijke normen.

Passieve shunt-diode barrières

Opmerking: Een goed geregelde voedingsspanning is vereist.

Producent	Onderdeelnummer
MTL	787SP+ (Dubbel kanaal)
MTL	7787P+ (Dubbel kanaal)
Stahl	9001/01-280-100-10 (Enkel kanaal)
Stahl	9002/01-280-110-10 (Dubbel kanaal)

Selecteren van een passieve barrière voor de SITRANS LR200

Voer, om te waarborgen dat de veiligheidsomschrijving van de barrière geschikt is voor de LR200 intrinsiekveilige ingangsparemeters, de volgende berekeningen uit:

- Re-e = max. end-to-end weerstand van de barrière
- Rloop = Lusweerstand (totaal van de kabelweerstand plus bijv. detectieweerstand, displays, en/of PLC Ingangen)
- Vbarrier = waarde van enige a-lineaire spanning daalt als gevolg van de barrière

- 1) Bepaal de waarde voor Re-e uit het datablad.
- 2) Bereken de totale waarde voor Rloop: door het toevoegen van bijvoorbeeld, detectieweerstand, displays en/of PLC Ingangen.
- 3) Bereken Rworking = Re-e + Rloop.

- 4) Bepaal de waarde van Vbarrier uit het barrière datablad (bijvoorbeeld spanningsval als gevolg van diodes).
- 5) Bereken Vworking = Vsupply – Vbarrier.

Gebruik de waarden voor Vworking en Rworking om te bevestigen dat de werking binnen het gearceerde gebied van figuur *Curve 1 (General Purpose, intrinsiekveilig, niet-ontstekend)* op pagina 24 valt.

Opmerkingen:

- De volgende lijst is niet volledig: er zijn vele intrinsiekveilige voedingen en barrières op de markt die zullen werken met de LR200.
- De PLC ingangsmodule en barrières die hieronder zijn vermeld zijn alle getest en functioneel compatibel met de LR200.

Actieve barrières (herhalende barrières)

Producent	Onderdeelnummer
MTL	706
MTL	7206
Stahl	9001/51-280-110-14
Pepperl+Fuchs	KSD2-CI-S-Ex
Pepperl+Fuchs	KFD2-STC3-Ex1
MTL	E02009 - verifieer
MTL	E02010

Instructies speciaal voor installatie in explosiegevaarlijke zones:

(Referentie Europese ATEX richtlijn 94/9/EC, Annex II, 1/0/6)

De volgende instructies gelden voor de apparatuur waarvoor het de certificaatnummers SIRA 06ATEX2378X, SIRA 05ATEX1001X gelden:

- 1) Raadpleeg de volledige handleiding voor gebruik en montage.
- 2) De apparatuur is gecertificeerd voor gebruik als Category 1G apparatuur.
- 3) De apparatuur mag worden gebruikt met ontbrandbare gassen en dampen met apparaatgroepen IIA, IIB, en IIC, en temperatuurklassen T1, T2, T3, en T4.
- 4) De apparatuur is gecertificeerd voor gebruik in een omgevingstemperatuurbereik van – 40°C tot +80°C.
- 5) De apparatuur is niet getest als veiligheidstoestel (zoals omschreven in richtlijn 94/9/EC Annex II, clause 1.5).
- 6) Installatie en inspectie van deze apparatuur moet worden uitgevoerd door voldoende opgeleid personeel, conform de geldende normen (EN 60079-14 en EN 60079-17 in Europa).

- 7) De apparatuur kan niet worden gerepareerd.
- 8) De certificaatnummers hebben een 'X' suffix, hetgeen aangeeft dat speciale condities van toepassing zijn voor veilig gebruik. Diegene die deze apparatuur installeren of inspecteren moeten toegang hebben tot de certificaten.
- 9) Wanneer de apparatuur in contact kan komen met agressieve stoffen, dan is het de verantwoordelijkheid van de gebruiker om de nodige maatregelen te nemen om te voorkomen dat het instrument negatief wordt beïnvloed, en zo te waarborgen dat de typeclassificatie niet in gevaar komt.

Agressieve stoffen:

bijvoorbeeld zure vloeistoffen of gasen die metalen aantasten, of oplosmiddelen die invloed kunnen hebben op polymeren.

Geschikt voorzorgsmaatregelen:

bijvoorbeeld, vaststellen aan de hand van het datablad van het materiaal dat het bestand is tegen specifieke chemische stoffen.

Activeren van de SITRANS LR200

Inschakelen van het instrument. SITRANS LR200 start automatisch op in de meetmodus. (Om de displaytaal te wijzigen, zie *Selecteren van een getoonde optie (bijvoorbeeld, kiezen van een taal)* op pagina 17.)

Het LCD

Meetmodus (normaal bedrijf)

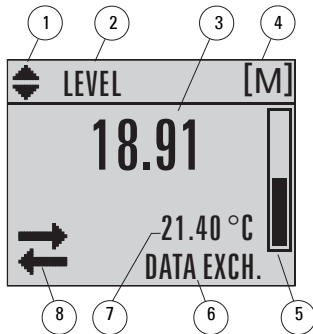

- 1 – toggle indicator voor lineaire eenheden of %
- 2 – geselecteerde bedrijf: niveau, ruimte of afstand
- 3 – meetwaarde (niveau of volume, ruimte of afstand)
- 4 – eenheden
- 5 – bargraph geeft niveau aan
- 6 – secundaire gebied op verzoek¹⁾ temperatuur van de elektronica, echo confidence, lusstroom of afstand
- 7 – tekstgebied toont statusmeldingen
- 8 – instrument statusindicator

Storing aanwezig



S: 0 LOE

- 7 – tekstgebied toont een foutcode en een foutmelding
- 8 – service nodig pictogram verschijnt

PROGRAM modus

Navigatieweergave

- Een zichtbare schuifbalk geeft aan dat de menulijst te lang is om alle items in één keer weer te geven.
- Een kleinere schuifbalk betekent een grotere menulijst.

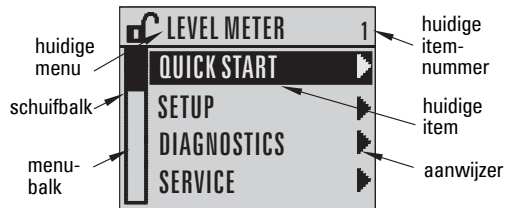

¹⁾ Als response op een ingedrukte toets. Zie *Toetsfuncties in de Meetmodus* op pagina 15.

Parameterweergave

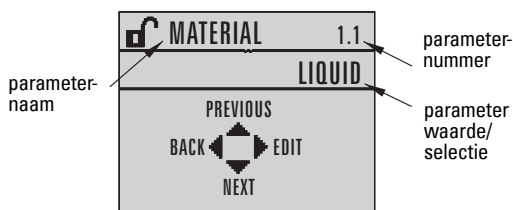

Bewerken weergave

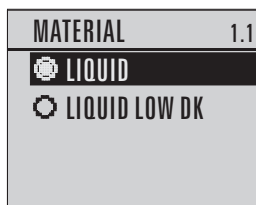

Handprogrammeereenheid





(Artikelnummer 7ML1930-1BK)

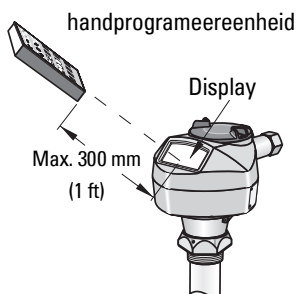



De programmeereenheid wordt separaat besteld.

- Richt de programmeereenheid op het display (maximale afstand 300 mm [1 ft.]).
- Druk op  Mode om te schakelen tussen de Meet- en PROGRAM modus.



Toetsfuncties in de Meetmodus

Toets	Functie	Resultaat
	Modus opent PROGRAM modus.	Opent het menuniveau dat het laatst is weergegeven tijdens deze inschakelcyclus, of menuniveau 1 wanneer de voeding is geschakeld sinds de PROGRAMMEER modus of dat meer dan 10 minuten zijn verstreken sinds de PROGRAMMEER modus is gebruikt.
	Pijl rechts opent PROGRAM modus.	Opent menuniveau 1.
 	Pijl omhoog of omlaag schakelt tussen lineaire eenheden en percentage.	LCD toont meetwaarde in lineaire eenheden of percentage.

Toets	Funcie	Resultaat
	Update de lusstroom.	Nieuwe waarde wordt op LCD weergegeven in secundair gebied.
	Update de temperatuur-aanwijzing van de temperatuur in de behuizing.	
	Update echobetrovbaarheidswaarde.	
	Update afstandmeting.	

Programmeren van de SITRANS LR200

Opmerking: De SITRANS LR200 keert automatisch terug naar de Meetmodus na een periode van inactiviteit in de PROGRAM modus (tussen 15 seconden en 10 minuten, afhankelijk van het menuniveau).

De instellingen kunnen lokaal worden gewijzigd via de lokale gebruikersinterface of op afstand via SIMATIC PDM. De lokale gebruikersinterface (LUI) bestaat uit een LCD en een handprogrammeereenheid.

- Zie *Quick Start Wizard via de handprogrammeereenheid* op pagina 18.
- Zie *Quick Start Wizard via SIMATIC PDM* op pagina 21.

Parametermenu's

Opmerking: Raadpleeg voor een volledig overzicht van parameters met instructies de uitgebreide handleiding. Deze kan worden gedownload vanaf de productpagina of onze website: www.siemens.com/LR200.

Parameters worden geïdentificeerd met een naam en zijn gerangschikt in functiegroepen en vervolgens in een 5-niveau menustructuur.

1. QUICK START

2. SETUP

3. DIAGNOSTICS

3.14. MEAS. VALUES





3.14.1. CURR. INTERN. TEMP.

Toegang tot parameters via de handprogrammeereenheid

1. Naar de PROGRAM modus



- Richt de programmeereenheid op het display vanaf maximaal 300 mm (1 ft.).
- Druk op de **PIJL naar rechts**  om menuniveau 1 te openen.

2. Navigatie: toetsfuncties in Navigatie modus

Toets	Naam	Menunive au	Functie
	Pijl omhoog of omlaag	menu of parameter	<ul style="list-style-type: none"> Blader naar vorig of volgende menu-item of parameter.
	Pijl rechts	menu	<ul style="list-style-type: none"> Ga naar de eerste parameter in het geselecteerde menu of open het volgende menu.
		parameter	<ul style="list-style-type: none"> Open Edit modus.
	Pijl links	menu of parameter	<ul style="list-style-type: none"> Open bovenliggende menu.
	Modus	menu of parameter	<ul style="list-style-type: none"> Schakel naar MEET modus.
	Home	menu of parameter	<ul style="list-style-type: none"> Open menuniveau 1.

3. Bewerken in PROGRAM modus

Selecteren van een getoonde optie (bijvoorbeeld, kiezen van een taal)

- Navigeer naar **Language (7)**.
- Druk op de **PIJL naar rechts**  om een parameter view te openen.
- Druk opnieuw op de **rechter PIJL**  om de **Edit** modus te openen. De huidige selectie is gemarkeerd.

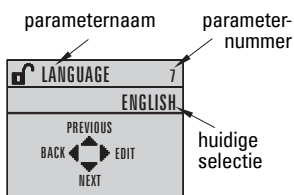

- Blader naar een nieuwe selectie.

Druk op de **PIJL naar rechts**  om deze te accepteren. Het display keert terug naar de weergave van de parameters en toont de nieuwe selectie.

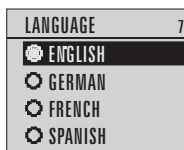

- Druk op de pijl **LINKS**  om terug te gaan naar het menu.

Wijzigen van een numerieke waarde

- Navigeer naar de gewenste parameter.
- Druk op de **PIJL naar rechts**  om parameterweergave te openen. De huidige waarde wordt weergegeven.

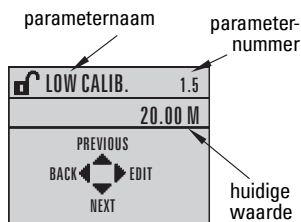



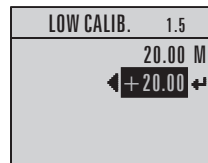



- c) Druk opnieuw op de **rechter PIJL**  om de **Edit** modus te openen. De huidige waarde wordt gemarkeerd.
- d) Voer een nieuwe waarde in en druk op de **Pijl naar**



RECHTS  om deze te accepteren.

Het display keert terug naar de weergave van de parameters en toont de nieuwe selectie.



Toetsfuncties in Edit modus





Toets	Naam	Functie	
	Pijl omhoog of omlaag	Selecteren van opties	<ul style="list-style-type: none"> • Bladert naar item.
		Numerieke bewerken	<ul style="list-style-type: none"> • verhoogt of verlaagt posities • - Schakelt tussen plus- en minteken
	Pijl rechts	Selecteren van opties	<ul style="list-style-type: none"> • Accepteert de data (schrijft de parameter) • Wijzigt van Edit naar Navigatie modus
		Numerieke bewerking	<ul style="list-style-type: none"> • Verplaatst de cursor een spatie naar rechts • of met de cursor op het Enter teken, accepteert de data en schakelt van de Edit naar de Navigatie modus
	Pijl links	Selecteren van opties	<ul style="list-style-type: none"> • verlaat de Edit modus zonder de parameter te wijzigen.
		Numerieke bewerking	<ul style="list-style-type: none"> • Verplaatst de cursor naar plus/min teken wanneer dit de eerste toets is die wordt ingedrukt • of verplaatst de cursor één spatie naar links.
	Clear	Numerieke bewerking	<ul style="list-style-type: none"> • Wist het display.
	Decimale punt	Numerieke bewerking	<ul style="list-style-type: none"> • Voert een decimale punt in.
	Plus/min teken	Numerieke bewerking	<ul style="list-style-type: none"> • Verandert het teken van de ingevoerde waarde.
	Numeral	Numerieke bewerking	<ul style="list-style-type: none"> • Voert het corresponderende karakter in.

Quick Start Wizard via de handprogrammeereenheid

Opmerking: Elke keer dat de Quick Start Wizard wordt gestart, zijn de opstartinstellingen de standaard fabrieksinstellingen. De Wizard roept geen eerder gemaakt gebruikersinstellingen op.

1. Quick Start

- Richt de handprogrammeereenheid op het display (vanaf een afstand van max. 300 mm [1 ft.]), druk dan op de PIJL naar RECHTS  om de PROGRAM modus te activeren en om menuniveau 1 te openen.
- Druk tweemaal op de **PIJL naar rechts**  om naar menu-item 1.1 te gaan en de parameterweergave te openen.

- c) Druk op de **PIJL naar rechts**  om de **Edit** modus te openen of op de **PIJL naar beneden**  om de standaard waarden te accepteren en direct verder te gaan naar het volgende item.
- d) Blader naar het gewenste item of voer een nieuwe waarde in om een instelling te wijzigen.
- e) Druk, na het wijzigen van een waarde, op de **rechter PIJL**  om deze te accepteren en druk op de **PIJL naar beneden**  om verder te gaan naar het volgende item.
- f) Quick Start instellingen worden pas actief nadat u **Yes** kiest om de **wijzigingen toe te passen** in stap 1.7.

1.1. Product:

Opties	LIQUID
	LIQUID LOW DK (diëlektrische vloeistof laag)

1.2. Responsiesnelheid

Stelt de reactiesnelheid in van het apparaat op wijzigingen in de meetwaarden in het doelbereik.

Opties	SLOW	0,1 m/minuut
	MED	1,0 m/minuut
	SNEL	10,0 m/minuut

Gebruik een instelling die net iets sneller is dan de maximale vul- of leegsnelheid (welke maar groter is).

1.3. Sensoreenheden:

Selecteert de eenheden voor de Quick Start variabelen (hoog- en laag kalibratiepunt en niveau, afstand of ruimte).

Opties	M, CM, MM, FT, IN
---------------	-------------------

1.4. Bediening

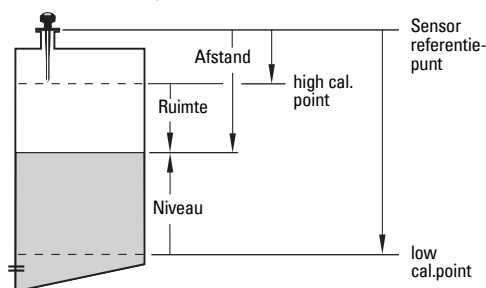

Bedrijf- stypes	NO SERVICE	De SITRANS LR200 stopt met het updaten van metingen en bijbehorende lusstroom. De laatste geldige meting wordt weergegeven.
	Niveau	Afstand van het materiaaloppervlak ten opzichte van Low Calibration Point (proces leeg niveau).
	Ruimte	Afstand van het materiaaloppervlak ten opzichte van High Calibration Point (proces vol niveau).
	Afstand	Afstand tot materiaaloppervlak ten opzichte van het sensorreferentiepunt.

1.5. Low Calibration Point

Afstand van de sensorreferentie tot Low Calibration Point: doorgaans het proces leeg niveau.

Waarden	Bereik: 0,0000 tot 20,000 m
----------------	-----------------------------

1.6. High Calibration Point

Afstand van de sensorreferentie tot High Calibration Point: doorgaans proces vol niveau.

Waarden	Bereik: 0,0000 tot 20,000 m
----------------	-----------------------------

1.7. Apply? (Pas wijzigingen toe)



Om de Quick Start instellingen te bewaren, is het noodzakelijk om **Yes** te kiezen om de wijzigingen toe te passen.

Opties	YES, NO
---------------	---------

Op het display verschijnt **DONE** wanneer de Quick Start succesvol is afgerond.

Druk op **Mode**  om terug te keren naar de meetmodus. De SITRANS LR200 is nu gereed voor bedrijf.

Opvragen van een echoprofiel

- 1) Ga in de PROGRAM modus naar: **Level Meter > Diagnostics (3) > Echo Profile (3.1)**.
- 2) Druk op **pijl naar RECHTS**  om een profiel op te vragen.
- 3) Druk in het profielscherm op de **pijl OMHOOG**  om het **Zend** pictogram te selecteren en op de **pijl naar RECHTS** om het profiel bij te werken.
- 4) Druk op de **pijl naar BENEDEN**  om het **Exit** pictogram te selecteren en kies vervolgens de **pijl naar RECHTS** om terug te gaan naar het vorige menu.

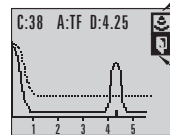
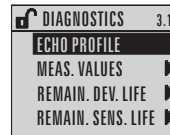

zend pictogram, gedeselecteerd

exit pictogram, geselecteerd

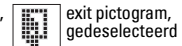

SITRANS LR200 Communicatie: HART

- U heeft de uitgebreide handleiding nodig voor de lijst van parameters die van toepassing zijn.
- Wij raden het gebruik aan van de Simatic Process Device Manager (PDM) voor het programmeren van uw apparaat.

SIMATIC PDM

Opmerkingen:

- Wij raden het gebruik aan van SIMATIC PDM Rev. 6.0 SP3 of hoger.
- SIMATIC PDM Rev. 5.2 SP1 wordt alleen ondersteund voor basisconfiguratie en probleemoplossen. Voor geavanceerde functies, zoals de Quick Start wizard, is revision 6.0 SP3 of hoger nodig.

SIMATIC PDM is een softwarepakket dat wordt gebruikt voor het in bedrijf nemen en onderhouden van de SITRANS LR200 en andere procesapparaten. Raadpleeg de bedieningshandleidingen of online help voor het gebruik van SIMATIC PDM. (U kunt meer informatie vinden onder www.siemens.com/simatic-pdm: ga naar **Products and Solutions > Products and Systems > Communication and Software > Process Device Manager**.)

Electronic Device Description (EDD)

- U kunt de EDD vinden in de Device Catalog, onder **Sensors/Level/Echo/Siemens Milltronics/SITRANS LR200**.
- Zie de productpagina van onze website: www.siemens.com/LR200, onder **Downloads**, om er zeker van te zijn dat u de meest recente versie heeft van SIMATIC PDM, het meest recente Service Pack (SP) en de meest recente hot fix (HF). Wanneer u een nieuwe EDD moet installeren, zie dan *Configureren van een nieuw apparaat* hierna.

Configureren van een nieuw apparaat

Opmerking: door op **Cancel** te drukken tijdens het uploaden van een apparaat naar SIMATIC PDM worden enkele parameters bijgewerkt.

1. Controleer of u beschikt over de meest recente EDD en indien nodig deze downloaden vanaf de productpagina die hierboven is vermeld. Sla de bestanden op uw PC op en pak de gezipte bestanden uit in een gemakkelijk toegankelijke map. Start **SIMATIC PDM – Manager Device Catalog**, blader naar het uitgepakte EDD bestand en selecteer het.
2. Start SIMATIC PDM en creëer een nieuw project voor LR200. Applicatiehandleidingen voor het instellen van HART apparaten met SIMATIC PDM kunnen worden gedownload vanaf de productpagina van onze website: www.siemens.com/LR200.
3. Upload de parameters naar de PC/PG.
4. Configureer het apparaat via de Quick Start wizard (zie hieronder).

Quick Start Wizard via SIMATIC PDM

Opmerkingen:

- De Quick Start wizard instellingen zijn onderling gerelateerd en wijzigingen worden pas toegepast wanneer u op **Transfer** klikt aan het einde van stap 5.
- Elke keer dat de Quick Start Wizard wordt gestart, zijn de opstartinstellingen de standaard fabriekinstellingen. De Wizard roept geen eerder gemaakt gebruikersinstellingen op.
- Klik op **BACK** om terug te gaan en een instelling te wijzigen of kies **Cancel** om de Quick Start te verlaten.

Start SIMATIC PDM, open het menu **Device – Quick Start** en volg de stappen 1 t/m 5.

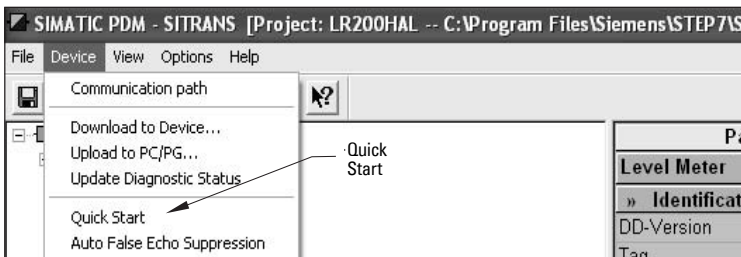

Onderhoud

De SITRANS LR200 vereist geen onderhoud of reiniging onder normale bedrijfsomstandigheden. Wanneer reiniging nodig wordt onder extreme omstandigheden:

1. Houd rekening met het materiaal van de antenne en het procesmedium en kies een reinigingsmiddel dat op beide geen negatieve invloed heeft.
2. Neem het instrument uit bedrijf en veeg de antenne schoon met een doek en een oplossing van een geschikt reinigingsmiddel.

Reparatie van de eenheid en uitsluiting van aansprakelijkheid

Raadpleeg voor gedetailleerde informatie de binnenkant van de achterflap.

Maximum procestemperatuurgrafiek

! Waarschuwing: De interne temperatuur mag niet hoger zijn dan 80 °C (176 °F).

Maximale flens en procestemperaturen versus toegestane Omg. Temp. voor flensadapterversie van de SITRANS LR200

- De tabel dient uitsluitend als richtlijn.
- De grafiek vertegenwoordigt niet elke mogelijke procesaansluitingsconfiguratie. Deze geldt bijvoorbeeld NIET wanneer u de SITRANS LR200 direct op een metalen tankoppervlak monteert.
- De grafiek houdt geen rekening met opwarming als gevolg van blootstelling aan direct zonlicht
- U kunt parameter 3.14.1 gebruiken voor het bewaken van de actuele inwendige temperatuur.

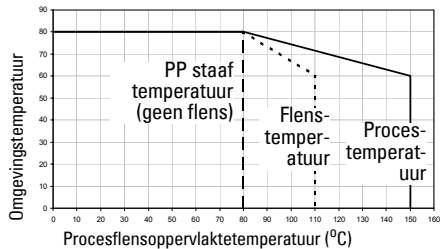

Loop-voeding

Typische aansluitingstekening

Opmerking: Lusspanning is de spanning op de klemmen van de voeding (niet de spanning op de klemmen van het apparaat).

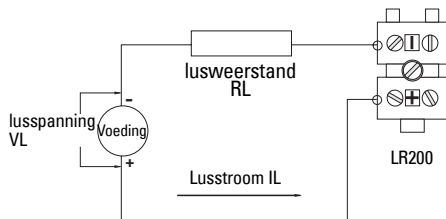

TOEGESTAAN BEDRIJFSGBIED

Curve 1 (General Purpose, intrinsiekveilig, niet-ontstekend)

Lusspanning versus lusweerstand

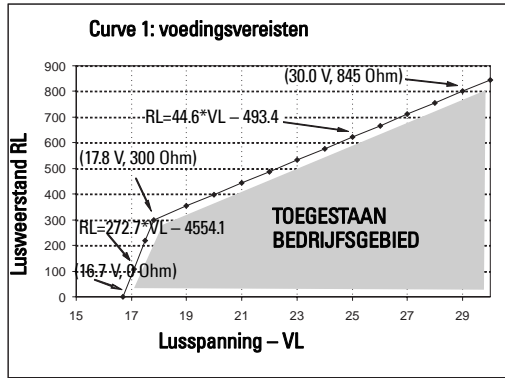

Curve 2 (Vlambestendig, verhoogde veiligheid, explosie veilig)

Loop-spanning versus Loopweerstand

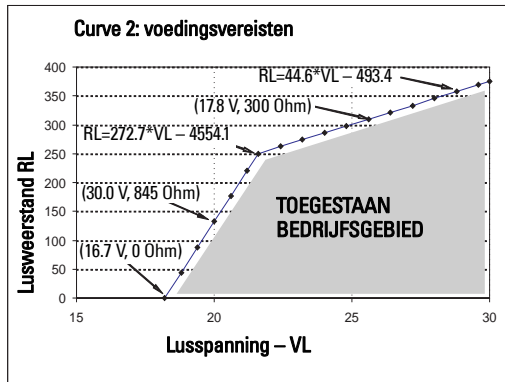

Opstartcurve

Opmerking: Na het opstarten kan het 25 tot 55 seconden duren voordat het instrument het daadwerkelijke materiaalniveau weergeeft.

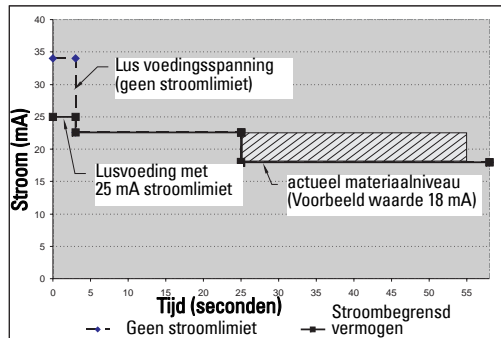

Nederlands

Opmerkingen

SITRANS LR200 (HART) com a Interface da LUI da Siemens: Manual de Início Rápido

Este manual descreve as características e funções essenciais do SITRANS LR200 (HART). Aconselhamos categoricamente que você adquira a versão detalhada do manual para poder utilizar o máximo potencial de seu dispositivo. O manual completo pode ser baixado na página do produto SITRANS LR200, em nosso website, em: www.siemens.com/LR200. O manual impresso está disponível com seu representante local Siemens Milltronics.

Quaisquer dúvidas acerca do conteúdo deste manual devem ser dirigidas a:

Siemens Milltronics Process Instruments Inc.
1954 Technology Drive, P.O. Box 4225
Peterborough, Ontário, Canadá, K9J 7B1
E-mail: techpubs.smpi@siemens.com

**Copyright Siemens Milltronics
Process Instruments Inc. 2008.
Todos os direitos reservados**

Exclusão de Responsabilidade

Aconselhamos os usuários a adquirirem manuais autorizados relacionados ou a verem versões eletrônicas conforme projetadas e autenticadas pela Siemens Milltronics Process Instruments Inc. A Siemens Milltronics Process Instruments Inc. não será responsabilizada pelo conteúdo de reproduções parciais ou totais de versões relacionadas ou eletrônicas.

Apesar de termos verificado o conteúdo deste manual relativamente à conformidade com os instrumentos descritos, este pode ter algumas variações. Dessa forma, não podemos garantir conformidade integral. O conteúdo deste manual é revisto com regularidade, e as correções são incluídas em edições posteriores. Todas as sugestões de aprimoramento são bem-vindas.

Os dados técnicos estão sujeitos a alterações.

MILLTRONICS é uma marca comercial registrada da Siemens Milltronics Process Instruments Inc.

Suporte Técnico

O suporte está disponível 24 horas por dia.

Para saber o endereço, número de telefone e número de fax do Escritório de Automação local da Siemens, acesse:

www.siemens.com/automation/partner:

- Clique na guia **Contacts by Product** (*Contatos por Produto*) e encontre seu grupo de produtos (**+Process Automation** (*Automação de Processos*)> **+Process Instrumentation** (*Instrumentação de Processos*)> **+Level Measuring Instruments** (*Instrumentos de Medição de Nível*)).
- Selecione o **Technical Support** (*Suporte Técnico*) da equipe. Clique em **Next** (*Avançar*).
- Clique em continente, depois em país, seguido por uma cidade. Clique em **Next**.

Para suporte técnico on-line, acesse: www.siemens.com/automation/support-request

- Digite o nome do dispositivo (SITRANS LR200) ou número do pedido; em seguida, clique em **Search** (*Pesquisar*) e selecione o tipo de produto apropriado. Clique em **Next**.
- Digite uma palavra-chave que descreva seu assunto. Em seguida, navegue pela documentação relevante ou clique em **Next** para enviar por e-mail a descrição de seu assunto para a equipe de Suporte Técnico da Siemens.

Centro de Suporte Técnico A&D Siemens:

telefone +49 180 50 50 222

fax +49 180 50 50 223

Instruções de segurança

As mensagens de advertência devem ser observadas para garantir sua segurança pessoal bem como a de terceiros e para proteger o produto e o equipamento associado. Essas mensagens de aviso são acompanhadas de um esclarecimento do nível de cautela a ser observado.



ADVERTÊNCIA: refere-se a um símbolo de advertência no produto e significa que o não cumprimento das precauções necessárias pode resultar em morte, ferimentos graves e/ou danos materiais consideráveis.



ADVERTÊNCIA¹⁾: significa que o não cumprimento das precauções necessárias pode resultar em morte, ferimentos graves e/ou danos materiais consideráveis.

Observação: significa informações importantes acerca do produto ou dessa parte do manual de operações.

Conformidade com a FCC

Apenas para instalações nos EUA: Normas da “Federal Communications Commission” (FCC) (Organismo norte-americano que regulamenta as comunicações nos EUA)



ADVERTÊNCIA: As alterações ou modificações não aprovadas expressamente pela Siemens Milltronics podem anular a autoridade do usuário de utilizar o equipamento.

Observações:

- Este equipamento foi testado e considerado em conformidade com os limites para um dispositivo digital da Classe A, de acordo com a Parte 15 das Regras da FCC. Estes limites foram concebidos para proporcionarem uma proteção razoável contra interferência nociva quando o equipamento é utilizado em um ambiente comercial.
- Este equipamento gera, utiliza e pode irradiar energia de radiofrequência e, se não for instalado e utilizado de acordo com o manual de instruções, pode causar interferências prejudiciais nas comunicações via rádio. É provável que o funcionamento deste equipamento em uma área residencial cause interferências prejudiciais nas comunicações via rádio; nesse caso, o usuário precisará corrigir a interferência à sua própria custa.

SITRANS LR200



ADVERTÊNCIA: O SITRANS LR200 deve ser usado apenas da forma descrita neste manual, caso contrário, a proteção fornecida pelo equipamento pode ser prejudicada.

Observação: Este produto é para ser usado em áreas industriais. A operação com este equipamento numa área residencial pode causar interferências a várias comunicações à base de frequência.

O SITRANS LR200 é um transmissor de nível de radar de pulsos de 2 fios e 6 GHz para monitoramento contínuo de líquidos e fluidos em vasos de armazenamento, incluindo alta pressão e alta temperatura, até um intervalo de 20 m (66 pés).

O dispositivo consiste em um componente eletrônico acoplado a uma antena em forma de chifre e/ou uma conexão de processo do tipo roscada ou flangeada.

¹⁾ Este símbolo é utilizado quando não existe qualquer símbolo de cautela correspondente no produto.

A comunicação é via HART¹⁾. Os sinais são processados utilizando-se Process Intelligence.

Especificações

Para obter uma listagem completa, consulte o Manual de Instruções do SITRANS LR200 (HART). Para informações de Aprovações, consulte a placa de identificação do dispositivo e o rótulo do dispositivo de processo.

Temperaturas Ambiente/Operacional

Observações:

- A temperatura de processo e as capacidades de pressão dependem das informações na etiqueta do dispositivo de processo. A ilustração de referência relacionada no rótulo de identificação pode ser baixada do site da Siemens: www.siemens.com/LR200.
- A temperatura máxima depende da conexão do processo, materiais da antena e pressão do vaso. Consulte *Gráfico de Temperatura Máxima do Processo* na página 22 para obter mais detalhes. As curvas de diminuição da Temperatura de Pressão do Processo estão disponíveis no manual completo.

temperatura ambiente (ao redor da caixa)
-40 °C a +80 °C (-40 °F a +176 °F)

temperatura do processo

Haste dupla:

-40 °C a +80 °C (-40 °F a +176 °F)

Haste PTFE ou antena SS:

-40 °C a +200 °C (-40 °F a +392 °F)

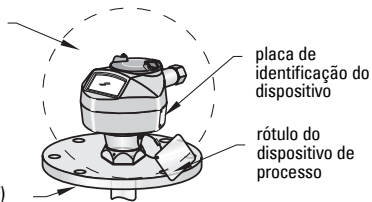

Alimentação



Finalidades Gerais:

Não-inflamável (somente para FM/EUA):

Segurança Intrínseca:

24 V DC nominais com
resistência máxima de
circuito de 550 Ohm.



À prova de fogo:

Mais Segurança:

À prova de explosão (FM/CSA somente para EUA/Canadá):

24 V DC nominais com
resistência máxima de
circuito de 250 Ohm.

Certificações

- Geral CSA_{US/C}, FM, CE
- Rádio Europa (R&TTE), FCC, Industry Canada

(continua na página seguinte)

¹⁾ HART[®] é uma marca comercial registrada da HART Communication Foundation.

- Perigoso À prova de fogo (Europa)¹⁾ ATEX II 1/2 G, EEx dm ia IIC T4
Mais Segurança (Europa)²⁾ ATEX II 1/2 G, EEx em ia IIC T4
À prova de explosão (EUA/Canadá)³⁾ FM/CSA: (barreira não necessária)
Classe I, Div. 1, Grupos A, B, C, D
Classe II, Div. 1, Grupos E, F, G
Classe III T4

Observação: Utilize selos de conduíte adequados para manter a classificação de IP ou NEMA.

Aprovações (continuação)

- Perigoso
 - Não-inflamável (EUA)⁴⁾ FM: (barreira não necessária)
Classe I, Div. 2, Grupos A, B, C, D, T5
 - Segurança Intrínseca⁵⁾
(Europa) ATEX II 1 G, EEx ia IIC T4
(EUA/Canadá) FM/CSA: (barreira necessária)
Classe I, Div. 1, Grupos A, B, C, D
Classe II, Div. 1, Grupos E, F, G
Classe III T4
 - (Austrália) ANZEX Ex ia IIC T4
(Tamb = -40 a +80 °C) IP67
 - (Internacional) IECEx TSA 04.0020X T4
- Marinho Registro de Embarque do Lloyd's
Aprovação do Tipo ABS

Programador (teclado numérico infravermelho)

Programador Manual Siemens Milltronics Infravermelho IS (Segurança Intrínseca) para locais perigosos e todos os outros (a bateria não é substituível e tem uma expectativa de vida útil de 10 anos de uso normal).

- aprovação ATEX II 1 G, EEx ia IIC T4, certificado SIRA 01ATEX2147
FM/CSA: Classe I, Div. 1, Grupos A, B, C, D
- temperatura ambiente -20 a 40 °C (-5 a 104 °F)
- interface sinal de pulso infravermelho de propriedade
- energia bateria de lítio 3 V
- peso 150 g (0,3 lb)
- cor preta
- Número da Peça 7ML1930-1BK

1) Consultar *Fiação elétrica à prova de fogo* na página 9.

2) Consultar *Mais segurança na instalação elétrica* na página 10.

3) Consultar *À prova de explosão (FM/CSA somente para EUA/Canadá)* na página 10.

4) Consultar *Instalação elétrica não inflamável (somente para FM/EUA)* na página 11.

5) Consultar *Instalação elétrica com segurança intrínseca* na página 11.

Aplicação de Pressão



! ADVERTÊNCIAS:

- Este produto foi projetado como um Acessório de Pressão segundo a Diretiva 97 / 23 / EC, e não se destina a ser utilizado como dispositivo de segurança.
- Jamais tente soltar, retirar ou desmontar a conexão do processo ou a caixa de instrumentos enquanto o conteúdo do vaso estiver sob pressão.
- Uma instalação incorreta pode resultar na perda de pressão do processo.

Instalação



! ADVERTÊNCIAS:

- A instalação só deverá ser efetuada por pessoal qualificado e em conformidade com os regulamentos locais vigentes.
- Os materiais de construção são escolhidos com base em suas capacidades químicas (ou inatividade) para finalidades gerais. Para exposição a ambientes específicos, verificar as tabelas de compatibilidade química, antes da instalação.

Observações:

- O Rótulo do Dispositivo de Processo deverá permanecer com a unidade de limites de pressão do processo¹⁾. Caso a embalagem do dispositivo seja substituída, a Identificação do Dispositivo de Processo deverá ser transferida para a unidade de substituição.
- As unidades SITRANS LR200 são hidrosticamente testadas, atendendo ou superando as exigências do Código de Caldeira e Vaso de Pressão da ASME e da Diretiva Europeia de Equipamentos de Pressão.

Diretrizes de instalação

- Fornecer acesso fácil para visualizar o monitor e programar por meio do programador manual.
- Fornecer um ambiente adequado à classificação da caixa e dos materiais de construção.
- Fornecer proteção solar se o dispositivo for montado em luz solar direta.

¹⁾ A unidade do limite de pressão do processo engloba os componentes que atuam como uma barreira contra a perda de pressão a partir do vaso do processo: ou seja, a combinação do corpo de conexão do processo e o emissor, mas normalmente se exclui a caixa elétrica.

Design do bocal

Observações:

- Para bocais de 100 mm (4") de comprimento ou inferiores, utilize a blindagem de 100 mm (4").
- Para bocais de 250 mm (10") de comprimento ou inferiores, utilize a blindagem de 250 mm (10").
- Para obter detalhes sobre outras aplicações, favor consultar o manual completo.

- A extremidade da seção de blindagem deve ser projetada, no mínimo, em 10 mm (0.4") a fim de evitar que falso ecos sejam refletidos a partir do bocal.

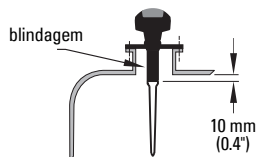

Localização de uma tampa de abertura

- Normalmente, uma tampa de abertura é um bocal coberto com diâmetro de 610 mm (24") ou superior.
- Para condições ideais do sinal, localize a antena em direção contrária ao centro, normalmente a 100 mm (4") a partir da lateral.

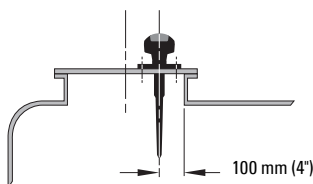

Localização do bocal

! ADVERTÊNCIA: Para vasos com as partes superiores cônicas ou parabólicas, evite montar o instrumento no centro. (A concavidade da parte superior pode concentrar os ecos no centro, o que gera falsas leituras.)

Observação: Em determinadas circunstâncias, pode ser aceitável montar o dispositivo no centro de um tanque com superfície superior plana. Por favor, consulte seu representante local Siemens.

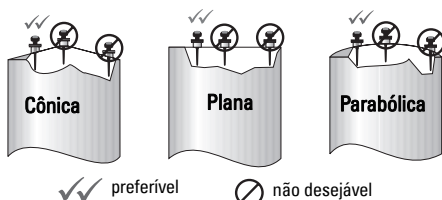

- Mantenha o cone de emissão sem interferências de escadas, tubos, vigas ou correntes de enchimento.
- Posicione a antena distante da parede lateral, a fim de evitar interferências de ecos indiretos.
- Permita a difusão do cone de emissão, a fim de evitar interferência com as paredes do vaso ou obstruções.

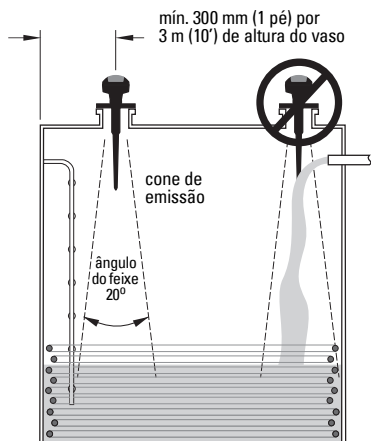

Instruções de instalação

Observações:

- Não há limite ao número de vezes que o dispositivo pode ser girado.
- Posicione a parte frontal ou posterior do dispositivo em direção à parede mais próxima do vaso.
- Não gire a caixa após a programação e configuração do dispositivo (uma alteração de polaridade do pulso de transmissão pode provocar erro).

Versão Roscada

- 1) Antes de inserir o dispositivo em sua conexão de montagem, verifique se as roscas são compatíveis para evitar danificá-las.
- 2) Parafuse o dispositivo na conexão do processo e aperte manualmente. Para aplicações de pressão, utilize fita de PTFE ou outro composto vedante de roscas apropriado e aperte a conexão de processo mais do que o aperto manual (torque máx. 40 Nm (30 pés-lbs.).
- 3) Para girar a caixa, primeiramente solte os três parafusos posicionados, pressionando o anel de travamento. Após posicionar a caixa, aperte os parafusos novamente.

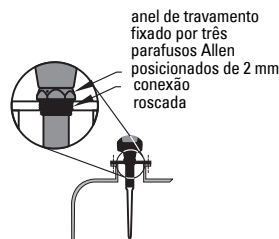

Versão Flangeada

! ADVERTÊNCIA: O usuário é responsável pela seleção dos materiais de aparafusamento e juntas que estejam dentro dos limites do flange e da sua utilização pretendida e que sejam adequados às condições de serviço.

Instalação Elétrica

Alimentação

ADVERTÊNCIAS:



Os terminais de entrada CC devem ser alimentados por uma fonte que proporcione isolamento elétrico entre a entrada e a saída para que sejam respeitadas as exigências de segurança da norma IEC 61010-1



Toda a instalação elétrica de campo deve ter um isolamento adequado às tensões especificadas.

Conectando o SITRANS LR200



! ADVERTÊNCIAS:

- Verifique a classificação de aprovação da placa de identificação do dispositivo e o rótulo de identificação do processo para verificar a classificação nominal.
- Utilize selos de conduíte adequados para manter a classificação de IP ou NEMA.
- Leia *Instruções específicas para instalações em áreas perigosas* na página 13.

Observações:

- Para obter instruções detalhadas sobre as ligações elétricas, consulte o manual de instruções completo.
- Utilize cabo de par trançado: de AWG 22 a 14 (de 0,34 mm² a 2,5 mm²).
- Poderão ser necessários cabos e conduítes separados por uma questão de conformidade com as práticas padronizadas de conexão de instrumentação ou códigos elétricos.

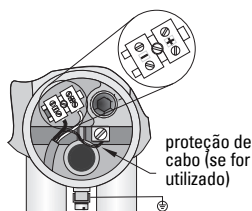
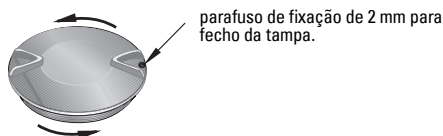

- 1) Utilize a chave Allen de 2 mm para soltar o parafuso de fixação da fechadura da tampa e, em seguida, desparafuse a tampa.
- 2) Retire o isolamento do cabo aproximadamente 70 mm (2,75") a partir do seu extremo e passe os fios pela bucha.
- 3) Ligue os fios aos terminais, conforme exibido: a polaridade está indicada no bloco de terminais.
- 4) Ligue o instrumento à terra de acordo com os regulamentos locais.
- 5) Aperte a bucha de forma a fornecer uma boa vedação.
- 6) Feche a tampa e confirme se o anel está travado antes da programação e da calibração do dispositivo. Não gire o dispositivo depois de ter sido configurado, pois isso pode provocar um erro.

Conexão do HART: configuração PLC/mA típica

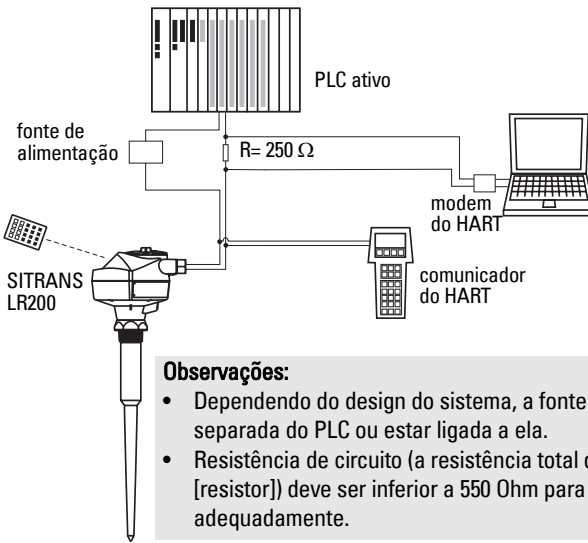

Observações:

- Dependendo do design do sistema, a fonte de alimentação pode ser separada do PLC ou estar ligada a ela.
- Resistência de circuito (a resistência total dos cabos mais 250 Ohm [resistor]) deve ser inferior a 550 Ohm para que o dispositivo funcione adequadamente.

Configurações da conexão elétrica para instalações em áreas perigosas

Observação: Os certificados e as ilustrações de conexão ATEX relacionados abaixo podem ser baixados da página do produto em nosso website: www.siemens.com/LR200.

Há cinco opções de instalação elétrica em áreas perigosas. Em todos os casos, verifique a classificação de aprovação na placa de identificação do dispositivo e no rótulo do dispositivo do processo.

1. Fiação elétrica à prova de fogo

SIEMENS			
SITRANS LR 200 7ML1234-56789-0ABC-D Serial No: GYZ/S1034567 End.: NEMA TYPE 4X, 6, IP67, IP68 Amb. Temp.: -40°C to 80°C Power Rating: 24V, ---, Nom., 30V, ---, Max., 4-20mA Siemens Milltronics Process Instruments Inc., Peterborough Made in Canada			
		II 1/2 G EEx dm ia IIC T4 SIRA 05ATEX1001X CE 0682 0518	HART Um = 250V

Classificação de Aprovação	Válida para:	Referência
ATEX II 1/2 G, EEx dm ia IIC T4	Europa	Flameproof/Increased Safety: ATEX Certificate na página A-1.

- Para exigências de alimentação, consulte *Curva 2 (À Prova de Fogo, Mais Segurança, À Prova de Explosão)* na página 23.
- Para as exigências de instalação elétrica, observe os regulamentos locais.
- Veja também *Instruções específicas para instalações em áreas perigosas* na página 13 e o certificado ATEX relacionado acima.

2. Mais segurança na instalação elétrica

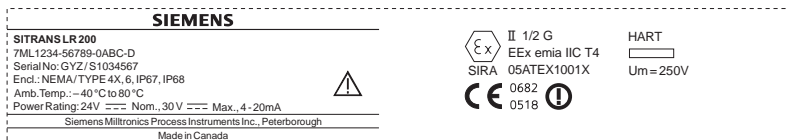

Classificação de Aprovação

Válida para: Referência

ATEX II 1/2 G, EEx em ia IIC T4

Europa

Flameproof/Increased Safety: ATEX Certificate na página A-1.

- Para exigências de alimentação, consulte *Curva 2 (À Prova de Fogo, Mais Segurança, À Prova de Explosão)* na página 23.
- Para as exigências de instalação elétrica, observe os regulamentos locais.
- Veja também *Instruções específicas para instalações em áreas perigosas* na página 13 e o certificado ATEX relacionado acima.

3. À prova de explosão (FM/CSA somente para EUA/Canadá)

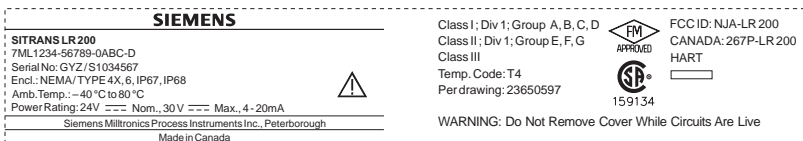

Classificação de Aprovação Válida para: Referência

FM/CSA:

Classe I, Div. 1, Grupos A, B, C, D

Classe II, Div. 1, Grupos E, F, G

Classe III T4

EUA/Canadá

Número de Ilustração da Conexão à Prova de Explosão FM/CSA 23650597

- Para exigências de alimentação, consulte *Curva 2 (À Prova de Fogo, Mais Segurança, À Prova de Explosão)* na página 23.
- Para exigências de instalação elétrica (somente para a América do Norte), consulte a ilustração de conexão relacionada acima, que pode ser baixada da página do produto em nosso website: www.siemens.com/LR200.

4. Instalação elétrica não inflamável (somente para FM/EUA)

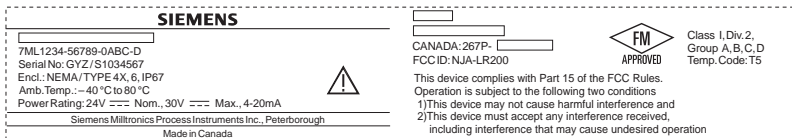

Classificação de Aprovação	Válida para:	Referência
FM: Classe I, Div. 2, Grupos A, B, C, D, T5	EUA	Número de Ilustração da Conexão FM Não Inflamável 23650537

- Para exigências de alimentação, consulte *Curva 1 (Finalidade Geral, Segurança Intrínseca, Não Inflamável)* na página 23.
- Para exigências de instalação elétrica (somente para a América do Norte), consulte a ilustração de conexão relacionada acima, que pode ser baixada da página do produto em nosso website: www.siemens.com/LR200.

5. Instalação elétrica com segurança intrínseca

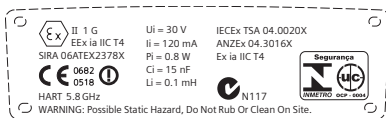
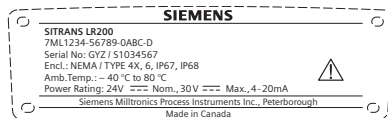
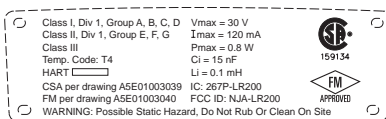
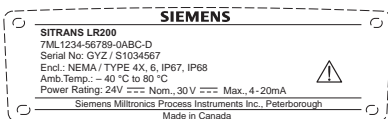

Classificação de Aprovação	Válida para:	Referência
FM/CSA: Classe I, Div. 1, Grupos A, B, C, D Classe II, Div. 1, Grupos E, F, G Classe III	EUA/Canadá	Número de Ilustração da Conexão FM com Segurança Intrínseca A5E01003040 Número de Ilustração da Conexão CSA com Segurança Intrínseca A5E01003039
ATEX II 1 G, EEx ia IIC T4	Europa	<i>Intrinsically Safe: ATEX Certificate</i> na página A-5
ANZEX Ex ia IIC T4 (Tamb = -40 a 80 °C) IP67	Austrália	
IECEX TSA 04.0020X	Internacional	

- Para exigências de alimentação, consulte *Curva 1 (Finalidade Geral, Segurança Intrínseca, Não Inflamável)* na página 23.

- Para requisitos de instalação elétrica:
 América do Norte: Consulte as ilustrações de conexão relacionadas acima, que podem ser baixadas da página do produto em nosso website: www.siemens.com/LR200.
 Europa: Siga os regulamentos locais.
 Austrália: Siga os regulamentos locais.
 Internacional: Siga os regulamentos locais.
- Utilize selos de conduíte adequados para manter a classificação de IP ou NEMA.
- As barreiras recomendadas de Segurança Intrínseca estão relacionadas em *Barreiras Passivas de Diodo em Desvio* na página 11.
- Consulte *Instruções específicas para instalações em áreas perigosas* na página 13 e o certificado ATEX relacionado acima.

Observação: A seleção de um módulo de entrada do PLC, fonte de alimentação ou barreira adequada requer conhecimentos sobre Segurança Intrínseca e sobre a aplicação. É de responsabilidade do instalador assegurar que a instalação intrinsecamente segura esteja em conformidade, tanto com os requisitos de aprovação do aparelho como com o código de prática nacional relacionado.

Barreiras Passivas de Diodo em Desvio

Observação: É necessária uma fonte de alimentação bem regulada.

Fabricante	Número de Peça
MTL	787SP+ (Canal duplo)
MTL	7787P+ (Canal duplo)
Stahl	9001/01-280-100-10 (Canal único)
Stahl	9002/01-280-110-10 (Canal duplo)

Como selecionar uma barreira passiva para o SITRANS LR200

Para garantir que a descrição de segurança da barreira seja adequada aos parâmetros de entrada de Segurança Intrínseca (IS) do LR200, realize os cálculos a seguir:

- Re-e = resistência máx. de uma ponta à outra da barreira
- Rloop = resistência do circuito (total de resistência do cabo mais, por exemplo, resistência de sentido, monitores e/ou entradas no PLC)
- Vbarreira = o valor de qualquer voltagem não-linear diminuí devido à barreira

- 1) Determinar o valor de Re-e da planilha de dados.
- 2) Calcular o valor total de Rloop: acrescentando, por exemplo, a resistência de sentido, monitores e/ou entradas no PLC.
- 3) Calcular a Rde trabalho = Re-e + Rloop.

- 4) Determinar o valor da Vbarreira na planilha de dados da barreira (por exemplo, a voltagem diminui devido aos diodos).
- 5) Calcular a Vde trabalho = Valimentação – Vbarreira.

Utilizar os valores para a Vde trabalho e Rde trabalho para confirmar que a operação está dentro da área escura do gráfico *Curva 1 (Finalidade Geral, Segurança Intrínseca, Não Inflamável)* na página 23.

Observações:

- A lista a seguir não está completa: há muitos suprimentos de energia e barreiras IS no mercado, os quais funcionam com LR200.
- Todos os módulos e barreiras de entrada no PLC relacionados abaixo foram testados e são funcionalmente compatíveis com LR200.

Barreiras ativas (barreiras repetidas)

Fabricante	Número de Peça
MTL	706
MTL	7206
Stahl	9001/51-280-110-14
Pepperl+Fuchs	KSD2-CI-S-Ex
Pepperl+Fuchs	KFD2-STC3-Ex1
MTL	E02009 - verificar
MTL	E02010

Instruções específicas para instalações em áreas perigosas

(Referência Européia ATEX Diretiva 94/9/CE, Anexo II, 1/0/6)

As instruções seguintes referem-se ao equipamento abrangido pelo certificado número SIRA 06ATEX2378X, SIRA 05ATEX1001X:

- 1) Para utilização e montagem, consulte as instruções principais.
- 2) O equipamento está certificado para ser utilizado como equipamento de Categoria 1G.
- 3) O equipamento pode ser utilizado com gases e vapores inflamáveis com os grupos de aparelhos IIC, IIB e IIA, e classes de temperatura T1, T2, T3 e T4.
- 4) O equipamento está certificado para ser utilizado dentro de um intervalo de temperatura ambiente de -40 °C a +80 °C.
- 5) O equipamento não foi avaliado como dispositivo relacionado com segurança (conforme mencionado na Diretiva 94/9/CE, Anexo II, cláusula 1.5).
- 6) A instalação e a inspeção deste equipamento serão efetuadas por pessoal com a formação adequada, de acordo com o código de práticas aplicável (EN 60079-14 e EN 60079-17 na Europa).

- 7) O equipamento não pode ser reparado.
- 8) Os números do certificado têm um sufixo 'X', que indica que se aplicam condições para o uso seguro. Os que forem instalar ou inspecionar este equipamento devem ter acesso aos certificados.
- 9) Se for provável que o equipamento entrará em contato com substâncias agressivas, é de responsabilidade do usuário tomar as precauções adequadas para que o equipamento não seja adversamente afetado, garantindo, portanto, que a proteção adotada não seja comprometida.

Substâncias agressivas: por exemplo, líquidos ou gases acidíferos que possam atacar os metais, ou solventes que possam afetar os materiais poliméricos.

Cuidados adequados: por exemplo, estabelecer que a planilha de dados do material seja resistente a produtos químicos específicos.

Ativação do SITRANS LR200

Ligue o instrumento. O SITRANS LR200 é iniciado automaticamente no modo Medição. (Para alterar o idioma exibido, consulte *Seleção de uma opção relacionada (por exemplo, selecção de um idioma)* na página 17.)

O Monitor de LCD

Modo Medição (operação normal)

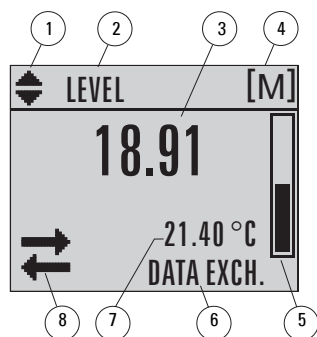

- 1 – indicador de alternância para unidades lineares ou %
- 2 – operação selecionada: level (*nível*), space (*espaço*) ou distance (*distância*)
- 3 – valor medido (nível ou volume, espaço ou distância)
- 4 – unidades
- 5 – o gráfico de barras indica o nível
- 6 – a região secundária indica a temperatura dos eletrônicos¹⁾ mediante solicitação, confiabilidade de eco, corrente de circuito ou distância
- 7 – a área de texto exibe mensagens de status
- 8 – indicador de status do dispositivo

Falha atual



S: 0 LOE

- 7 – a área de texto exibe um código de erro e uma mensagem de erro
- 8 – aparece o ícone serviço necessário

Modo PROGRAM

Visualização de Navegação

- Uma barra de menu visível indica que a lista de menus está longa demais para exibir todos os itens.
- Uma faixa de item mais profunda representa uma lista de menu mais sucinta.

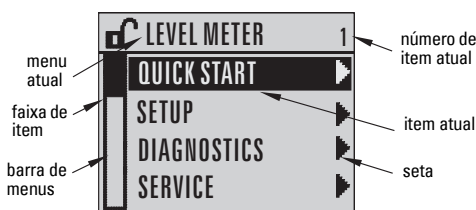

¹⁾ Em resposta a uma solicitação de tecla pressionada : Consultar *Funções das teclas no modo Medição* na página 15.

Visualização Parâmetros

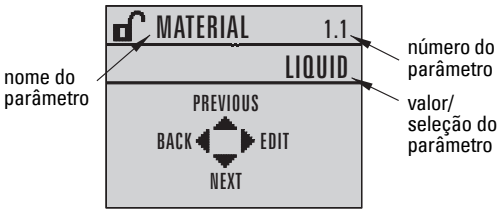

Visualização Editar

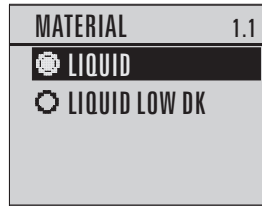

Programador Manual





(No. da Peça 7ML1930-1BK)

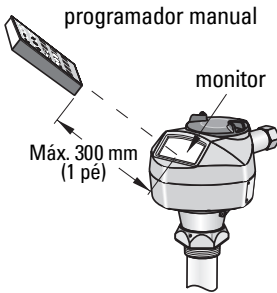



O programador é solicitado separadamente.

- Direcione o programador no monitor (de uma distância máxima de 300 mm [1 pé]).
- Pressione  Modo para alternar entre o modo Medição e o modo Program.



Funções das teclas no modo Medição

Tecla	Função	Resultado
	Modo abre o modo PROGRAM.	Abre o último nível de menu exibido neste ciclo de alimentação, ou nível de menu 1 se a alimentação tiver passado por um ciclo depois da saída do modo PROGRAM ou mais de 10 minutos tenham se passado desde que o modo PROGRAM foi utilizado.
	A seta DIREITA abre o modo PROGRAMA.	Abre o nível de menu 1.
 	Seta PARA CIMA ou PARA BAIXO alterna entre as unidades lineares e a percentagem.	O LCD exibe o valor medido em unidades lineares ou percentagem.

Tecla	Função	Resultado
	Atualiza a corrente do circuito.	O novo valor é exibido na região secundária do LCD.
	Atualiza a leitura da temperatura interna da caixa.	
	Atualiza o valor de confiabilidade do eco.	
	Atualiza a medição da distância.	

Programação do SITRANS LR200

Observação: O SITRANS LR200 retorna automaticamente ao modo Medição após um período de inatividade no modo PROGRAM (entre 15 segundos e 10 minutos, dependendo do nível de menu).

As configurações podem ser modificadas localmente por meio da Interface do Usuário ou remotamente por meio do SIMATIC PDM. A Interface do Usuário Local (LUI) consiste em um monitor de LCD e um programador manual.

- Consultar *Assistente de Início Rápido por meio do programador manual* na página 18.
- Consultar *Assistente de Início Rápido por meio de SIMATIC PDM* na página 21.

Menus de parâmetros

Observação: Para obter a lista completa de parâmetros com instruções, consulte o manual completo. Pode ser baixado da página do produto em nosso website: www.siemens.com/LR200.

Os parâmetros são identificados por nome e organizados em grupos de função e então organizados em uma estrutura de menus de 5 níveis.

1. QUICK START

2. SETUP

3. DIAGNOSTICS

3.14. MEAS. VALUES







3.14.1. CURR. INTERN. TEMP.

Parâmetros de acesso por meio do programador manual

1. Selecione o modo PROGRAM



- Direcione o programador no monitor de uma distância máxima de 300 mm (1 pés).
- Pressione a **seta DIREITA**  para abrir o nível de menu 1.

2. Navegação: funções das teclas em modo Navegação

Tecla	Nome	Nível de menu	Função
 	Seta PARA CIMA ou PARA BAIXO	menu ou parâmetro	<ul style="list-style-type: none"> Deslize a barra de rolagem para o menu ou parâmetro anterior ou seguinte.
	Seta DIREITA	menu	<ul style="list-style-type: none"> Acesse o primeiro parâmetro no menu selecionado ou abra o menu seguinte.
		parâmetro	<ul style="list-style-type: none"> Abrir o modo Editar.
	Seta ESQUERDA	menu ou parâmetro	<ul style="list-style-type: none"> Abrir o menu original.
	Modo	menu ou parâmetro	<ul style="list-style-type: none"> Altere para o modo MEDIÇÃO.
	Página inicial	menu ou parâmetro	<ul style="list-style-type: none"> Abra o nível de menu 1.

3. Edição no modo PROGRAM

Seleção de uma opção relacionada (por exemplo, seleção de um idioma)

- Navegue em **Language (Idioma)** (7).
- Pressione a **seta DIREITA**  para abrir a visualização de parâmetros.
- Pressione a **seta DIREITA**  uma vez mais para abrir o modo **Editar**. A seleção atual é destacada.
- Deslize com a barra de rolagem para uma nova seleção.

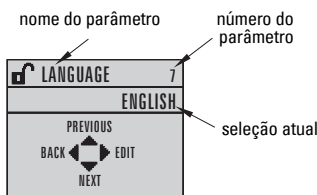



Pressione a **seta DIREITA**  para aceitar. O monitor LCD retorna para a visualização de parâmetros e exibe a nova seleção.

- Pressiona a **seta ESQUERDA**  para retornar ao menu.

Alteração de um valor numérico

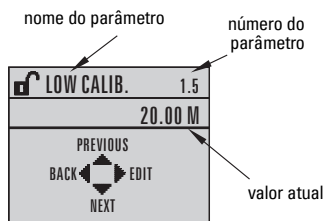
- Navegue até o parâmetro desejado.
- Pressione a **seta DIREITA**  para abrir a visualização de parâmetros. O valor atual é exibido.



- c) Pressione a **seta DIREITA**  uma vez mais para abrir o modo **Editar**. O valor atual é destacado.
- d) Digite um novo valor e pressione a **seta DIREITA**  para aceitar.

O monitor LCD retorna para a visualização de parâmetros e exibe a nova seleção.

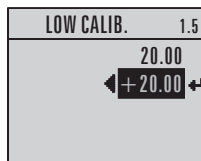



Funções das teclas no modo Editar





Tecla	Nome	Função	
 	Seta PARA CIMA ou PARA BAIXO	Seleção de opções	<ul style="list-style-type: none"> Desliza com a barra de rolagem até o item.
		Edição numérica	<ul style="list-style-type: none"> Acrescenta ou subtrai dígitos Alterna entre os sinais de mais e de menos
	Seta DIREITA	Seleção de opções	<ul style="list-style-type: none"> Aceita dados (grava o parâmetro). Altera do modo Editar para o modo Navegação
		Edição numérica	<ul style="list-style-type: none"> Move o cursor um espaço para a direita ou com o cursor no sinal Enter, aceita os dados e altera do modo Editar para o modo Navegação
	Seta ESQUERDA	Seleção de opções	<ul style="list-style-type: none"> Cancela o modo Editar sem alterar o parâmetro
		Edição numérica	<ul style="list-style-type: none"> Move o cursor para o sinal de mais/menos se esta for a primeira tecla pressionada ou move o cursor um espaço para a esquerda.
	Limpar	Edição numérica	<ul style="list-style-type: none"> Apaga a tela.
	Ponto decimal	Edição numérica	<ul style="list-style-type: none"> Adiciona um ponto decimal.
	Sinal de mais/menos	Edição numérica	<ul style="list-style-type: none"> Muda o sinal do valor inserido.
  para	Numeral	Edição numérica	<ul style="list-style-type: none"> Insera o caractere correspondente.

Assistente de Início Rápido por meio do programador manual

Observação: Cada vez que o Assistente de Início Rápido é iniciado, as configurações de inicialização retornam aos padrões de fábrica. O Assistente não registra configurações definidas anteriormente pelo usuário.

1. Início Rápido

- Aponte o programador para o monitor (a uma distância máxima de 300 mm [1 pé]), depois pressione a **seta DIREITA**  para ativar o modo PROGRAM e abra o menu nível 1.
- Pressione a **seta DIREITA**  duas vezes para navegar até o item de menu 1.1 e abrir a visualização de parâmetros.

- Pressione a **seta DIREITA**  para abrir o modo **Editar** ou a **seta PARA BAIXO**  para aceitar os valores padrão e ir diretamente para o item seguinte.
- Para alterar uma configuração, deslize com a barra de rolagem até o item desejado ou digite um novo valor.
- Após modificar um valor, pressione a **seta DIREITA**  para aceitá-lo e pressione a **seta PARA BAIXO**  para ir até o item seguinte.
- As configurações de Início Rápido são aplicadas somente depois de selecionar **Yes (Sim)** para **Apply changes (Aplicar alterações)** na etapa 1.7.

1.1. Material

Opções	LIQUID (LÍQUIDO)
	LIQUID LOW DK (líquido dielétrico baixo)

1.2. Taxa de Reação

Define a velocidade de reação do dispositivo às alterações de medição no intervalo de alcance.

Opções	SLOW (LENTA)	0,1 m/minuto
	MED (MED.)	1,0 m/minuto
	FAST (RÁPIDA)	10,0 m/minuto

Use uma configuração mais rápida do que a frequência máxima de enchimento ou esvaziamento (a que for maior).

1.3. Unidades de Sensor

Seleciona as unidades para as variáveis de Início Rápido (ponto de calibração alto e baixo, e nível, distância ou espaço).

Opções	M, CM, MM, FT, IN
---------------	-------------------

1.4. Funcionamento

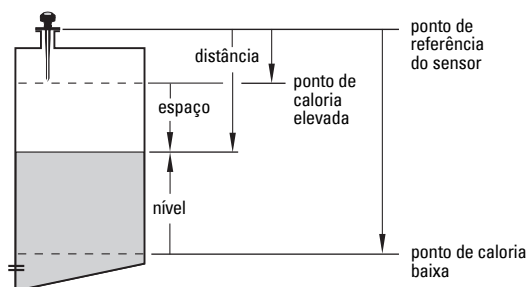

Tipos de operação	NO SERVICE (NÃO FUNCIONA)	O SITRANS LR200 interrompe a atualização de medição e a corrente de circuito associada. A última medida válida é exibida.
	LEVEL (NÍVEL)	Distância até a superfície do material indicada no Ponto de Calibração Baixo (nível de processo vazio).
	SPACE (ESPAÇO)	Distância até a superfície do material, indicada no Ponto de Calibração Alto (nível de processo total).
	DISTANCE (DISTÂNCIA)	Distância até a superfície de material indicada no Ponto de Referência do Sensor.

1.5. Ponto de Calibração Baixo

Distância da Referência do Sensor em relação ao Ponto de Calibração Baixo: normalmente nível de processo vazio.

Valores	Intervalo: 0,0000 a 20.000 m
----------------	------------------------------

1.6. Ponto de Calibração Alto

Distância da Referência do Sensor em relação ao Ponto de Calibração Alto: normalmente processo de nível total.

Valores	Intervalo: 0,0000 a 20.000 m
----------------	------------------------------

1.7. Apply? (Aplicar alterações)





*Para poder salvar as configurações de Início Rápido, é necessário selecionar **Yes (Sim)** para aplicar as alterações.*

Opções	YES (SIM), NO (NÃO)
---------------	---------------------

O monitor exibe **DONE (CONCLUÍDO)** quando o Início Rápido é concluído com sucesso.

Pressione **Modo**  para retornar ao modo Medição. Agora o SITRANS LR200 está pronto para funcionar.

Solicitação de Perfil de Eco

- No modo PROGRAM, acesse: **Level Meter** (*Medidor de Nível*) > **Diagnostics** (*Diagnóstico*) (3) > **Echo Profile** (*Perfil de Eco*) (3.1).
- Pressione a **seta DIREITA**  para solicitar um perfil.
- Na tela Perfil, pressione a **seta PARA CIMA**  para selecionar o ícone **Transmitir** e a **seta DIREITA**  para atualizar o perfil.
- Pressione a **seta PARA BAIXO**  para selecionar o ícone de **Saída** e, em seguida, a **seta DIREITA**  para retornar ao menu anterior.

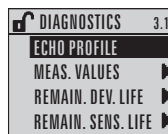

ícone de transmissão, desselecionado

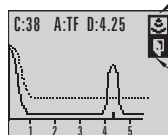

ícone de saída, selecionado



ícone de transmissão, selecionado



ícone de saída, desselecionado

Comunicações com o SITRANS LR200: HART

- Você precisará do manual completo para obter a lista dos parâmetros aplicáveis.
- Recomendamos que utilize o SIMATIC Process Device Manager (PDM) para programar o seu dispositivo.

SIMATIC PDM

Observações:

- Recomendamos a utilização do SIMATIC PDM Rev. 6.0 SP3 ou superior.
- O SIMATIC PDM Rev. 5.2 SP1 tem suporte apenas para configuração básica e resolução de problemas. Para recursos avançados, como o assistente de Início Rápido, é necessária a revisão 6.0 SP3 ou superior.

O SIMATIC PDM é um pacote de software utilizado para designar e preservar o SITRANS LR200 e outros dispositivos do processo. Consultar as instruções de funcionamento ou a ajuda on-line quanto a detalhes sobre a utilização do SIMATIC PDM. (É possível encontrar mais informações em www.siemens.com/simatic-pdm. Acesse **Products and Solutions** (*Produtos e Soluções*) > **Products and Systems** (*Produtos e Sistemas*) > **Communications and Software** (*Comunicações e Software*) > **Process Device Manager** (*Gerenciador de Dispositivo de Processo*)).

Descrição do Dispositivo Eletrônico (EDD)

- É possível localizar a EDD no Catálogo do Dispositivo, em **Sensors/Level/Echo/Siemens Milltronics/SITRANS LR200**.
- Verifique a página do produto em nosso website: www.siemens.com/LR200, em **Downloads**, para garantir que tem a versão mais recente do SIMATIC PDM, o Service Pack (SP) mais recente e as correções (HF) mais recentes. Se precisar instalar uma nova EDD, consulte *Configuração de um novo dispositivo* abaixo.

Configuração de um novo dispositivo

Observação: Clicar em **Cancel** (*Cancelar*) durante um upload a partir do dispositivo para o SIMATIC PDM resultará na atualização de alguns parâmetros.

1. Verifique se tem a EDD mais recente e, se necessário, faça o download dela na página do produto relacionada acima. Salve os arquivos em seu computador e extraia os arquivos comprimidos em um local de fácil acesso. Inicie o **SIMATIC PDM – Manager Device Catalog** (*Catálogo de Administração do Dispositivo*), acesse o arquivo EDD descomprimido e selecione-o.
2. Inicie o SIMATIC PDM e crie um novo projeto para LR200. As Guias de Aplicação para a configuração de dispositivos HART com SIMATIC PDM podem ser baixadas da página do produto em nosso site: www.siemens.com/LR200.
3. Faça o upload dos parâmetros para PC/PG.
4. Configure o dispositivo por meio do assistente de Início Rápido (consulte abaixo).

Assistente de Início Rápido por meio de SIMATIC PDM

Observações:

- As configurações do assistente de Início Rápido estão interligadas e as alterações se aplicam apenas após clicar em **Transfer** (*Transferir*) no final da etapa 5.
- Cada vez que o Assistente de Início Rápido é iniciado, as configurações de inicialização retornam aos padrões de fábrica. O Assistente não se lembrará das configurações definidas anteriormente pelo usuário.
- Clique em **BACK** (*RETORNAR*) para voltar e revisar uma configuração ou **Cancel** (*Cancelar*) para sair do Início Rápido.

Inicie o SIMATIC PDM, abra o menu **Device – Quick Start** (*Dispositivo – Início Rápido*) e siga as etapas 1 a 5.

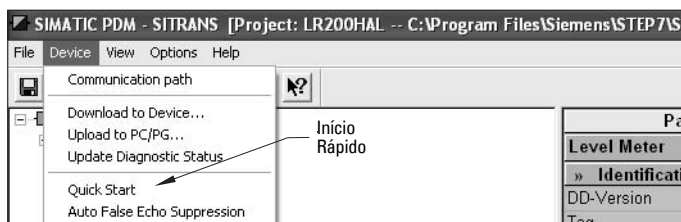

Manutenção

O SITRANS LR200 não necessita de manutenção ou limpeza em condições de funcionamento normais. Se for necessário fazer uma limpeza em condições de funcionamento difíceis:

1. Tome nota do material da antena e do meio de processo, e selecione uma solução de limpeza que não reaja de forma adversa com ambos.
2. Retire o dispositivo de operação e limpe a antena, utilizando um pano e uma solução de limpeza adequada.

Reparo da Unidade e Exclusões de Responsabilidade

Para obter informações detalhadas, consulte a contracapa interior.

Gráfico de Temperatura Máxima do Processo

! ADVERTÊNCIA: a temperatura interna não deve exceder 80 °C (176 °F).

Flange Máximo e Temperaturas do Processo versus ambiente admissível para versões do adaptador de flange do SITRANS LR200

- O gráfico abaixo é apenas para orientação.
- O gráfico não representa todas as organizações possíveis de conexão do processo. Por exemplo, NÃO se aplica se você estiver montando o SITRANS LR200 diretamente em uma superfície de vaso metálico.
- O gráfico não leva em conta o aquecimento resultante da exposição direta à luz solar
- É possível utilizar o parâmetro 3.14.1 para monitorar a temperatura interna atual.

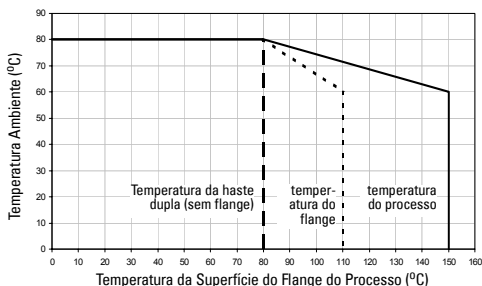

Alimentação do circuito

Desenho de Conexão Típica

Observação: A voltagem do circuito é a voltagem nos terminais da fonte de alimentação (e não a voltagem nos terminais do dispositivo).

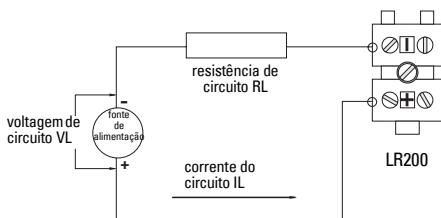

Área operacional autorizada

Curva 1 (Finalidade Geral, Segurança Intrínseca, Não Inflamável)

Voltagem de Circuito versus Resistência de Circuito

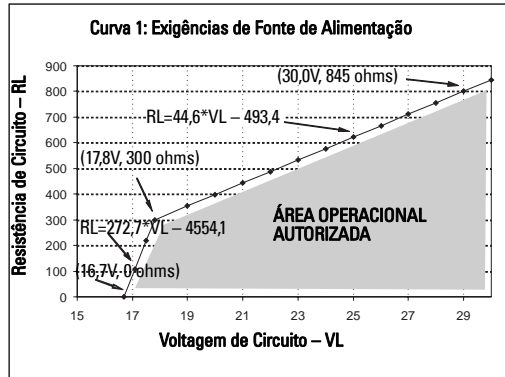

Curva 2 (À Prova de Fogo, Mais Segurança, À Prova de Explosão)

Voltagem de Circuito versus Resistência de Circuito

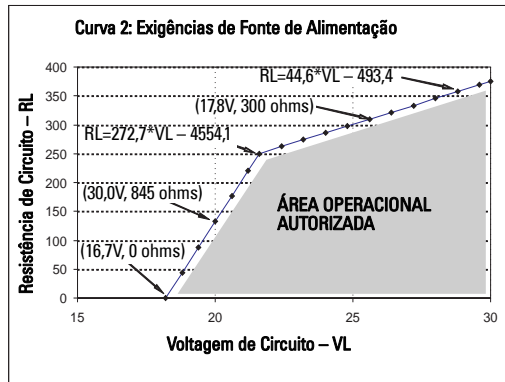

Curva de Inicialização

Observação: Na inicialização podem ser necessários de 25 a 55 segundos para que o dispositivo relate o nível material propriamente dito.

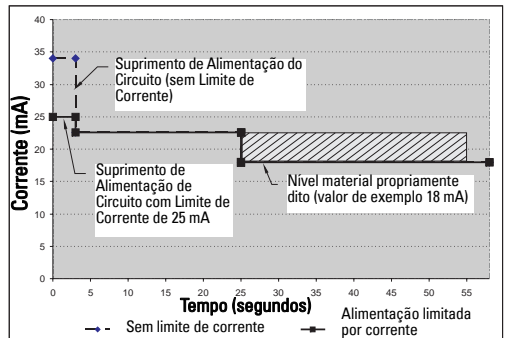

Observações

SITRANS LR200 (HART) ja Siemens- paikalliskäyttöliittymä (LUI): Pikakäyttöopas

Tämä opas kertoo SITRANS LR200 (HART) -laitteen ominaisuuksista ja toiminnoista. Suosittelemme, että hankit oppaan täydellisen version, jotta voisit käyttää laitetta mahdollisimman tehokkaasti. Täydellinen opas voidaan ladata SITRANS LR200 -tuotesivulta verkkosivuiltamme osoitteessa www.siemens.com/LR200. Painetun oppaan saat paikalliselta Siemens Milltronics -edustajaltasi.

Tämän oppaan sisältöä koskevia asioita voi tiedustella osoitteesta:

Siemens Milltronics Process Instruments Inc.
1954 Technology Drive, P.O. Box 4225
Peterborough, Ontario, Canada, K9J 7B1
Sähköposti: techpubs.smpi@siemens.com

**Copyright Siemens Milltronics
Process Instruments Inc. 2008.
Kaikki oikeudet pidätetään**

Vastuuvapauslauseke

Kehotamme käyttäjiä hankkimaan oppaan hyväksytyin painetun laitoksen tai tutustumaan Siemens Milltronics Process Instruments Inc:n laatimaan ja hyväksymään sähköiseen versioon. Siemens Milltronics Process Instruments ei vastaa osittain tai kokonaan kopioitujen painettujen tai sähköisten versioiden sisällöstä.

Tämän oppaan sisältö on tarkistettu vastaamaan kuvattua laitteistoa, mutta muutokset ovat mahdollisia. Tämän vuoksi valmistaja ei voi taata täydellistä yhtäpitävyyttä. Tämän oppaan sisältöä tarkistetaan säännöllisesti ja korjaukset sisällytetään seuraaviin painoksiin. Otamme parannusehdotuksia mielellämme vastaan.

Teknisiin tietoihin saattaa tulla muutoksia.

MILLTRONICS on Siemens Milltronics Process Instruments Inc:n rekisteröity tavaramerkki.

Tekninen tuki

Tukea on saatavissa 24 tuntia vuorokaudessa.

Löydät lähimmän paikallisen Siemens Automation -toimipaikan osoitteen sekä puhelin- ja faksinumeron osoitteesta

www.siemens.com/automation/partner:

- Napsauta välilehteä **Contacts by Product** (*Tuotekohtaiset yhteyshiedot*) ja etsi tuoteryhmä **(+Process Automation (Prosessiautomaatio) > +Process Instrumentation (Prosessin mittauslaitteet) > +Level Measuring Instruments (Tasonmittauslaitteet))**.
- Valitse teknisen tuen tiimi: **Technical Support**. Napsauta **Next** (*Seuraava*).
- Napsauta maanosaa ja sen jälkeen maata ja kaupunkia. Napsauta **Next**.

Jos haluat teknistä online-tukea, vieraile sivustossa www.siemens.com/automation/support-request

- Syötä laitteen nimi (SITRANS LR200) tai tilausnumero ja napsauta sen jälkeen **Search** (*Etsi*). Valitse sopiva tuotetyyppi. Napsauta **Next**.
- Syötä avainsana, joka kuvaa ongelmaasi. Siirry sen jälkeen sopivaan asiakirjaan tai napsauta **Next**, jolloin voit lähettää ongelmasi kuvauksen Siemensin tekniselle tukihenkilöstölle.

Siemens A&D Technical Support Center:

puhelin +49 180 50 50 222
faksi +49 180 50 50 223

Turvaohjeet

Annettuja varoituksia on noudatettava käyttäjään ja muihin henkilöihin kohdistuvien henkilövahinkojen sekä tuotteen ja siihen kytkettyjen varusteiden laitevahinkojen välttämiseksi. Varoitusten yhteydessä ilmoitetaan myös vaaratasosta.



VAROITUS: Varoitus liittyy tuotteen varoitussymboliin. Varoituksen huomiotta jättäminen saattaa aiheuttaa hengenvaaran, vakavia ruumiinvammoja ja merkittäviä aineellisia vahinkoja.



VAROITUS¹⁾: Varoituksen huomiotta jättäminen saattaa aiheuttaa hengenvaaran, vakavia ruumiinvammoja ja merkittäviä aineellisia vahinkoja.

Huomautus: Huomautuksissa on tärkeitä tuotteeseen tai käyttöoppaaseen liittyviä tietoja.

FCC-sääntöjen mukaisuus

Ainoastaan asennuksissa Amerikan Yhdysvaltoihin: Amerikan Yhdysvaltojen liittovaltion televalvontaviranomaisen (Federal Communications Commission, FCC) säännöt



VAROITUS: Laitteeseen tehdyt muutokset ja muokkaukset, joita Siemens Milltronics ei ole erikseen hyväksynyt, saattavat vaikuttaa laitteen käyttöoikeuksiin.

Huomautukset:

- Tämä laite on FCC-sääntöjen kohdan 15 mukaisten luokan A digitaalilaitteiden vaatimusten mukainen. Nämä vaatimukset on määritetty niin, että ne suojaavat laitteen haitallisilta häiriöiltä käytettäessä laitetta kaupallisessa ympäristössä.
- Tämä laite säteilee ja käyttää radiotaajuusenergiaa. Tämä saattaa häiritä radiolähetysten vastaanottoa, jos laitetta ei asenneta ja käytetä käyttöoppaan ohjeiden mukaan. Laitteen käyttäminen asuinalueilla saattaa aiheuttaa häiriöitä radioliikenteeseen. Käyttäjä vastaa itse tällaisten häiriöiden korjaamisesta.

SITRANS LR200



VAROITUS: SITRANS LR200:aa saa käyttää ainoastaan tässä käyttöoppaassa kuvatulla tavalla, koska muutoin laitteen suojaustaso voi heikentyä.

Huomautus: Tämä tuote on tarkoitettu käytettäväksi teollisuustiloissa. Laitteen käyttäminen asuinalueilla saattaa aiheuttaa häiriöitä monenlaisen radiotaajuuksia käyttävään viestintään.

SITRANS LR200 on kaksijohtiminen 6 GHz:n pulssitekniikkaa käyttävä laite, joka on tarkoitettu jatkuvaan neste- ja lietetason seurantaan varasto- ja prosessisäiliöissä, myös korkeassa lämpötilassa ja suuressa paineessa enintään 20 m:n (66 jalan) mittausalueella.

Laite koostuu elektroniikkapiiristä, joka on kytketty antenniin ja joko kierre- tai laippatyyppiseen prosessiliitäntään.

¹⁾ Tätä merkkiä käytetään, kun tuotteessa ei ole vastaavaa varoitussymbolia.

Viestinvälitys tapahtuu HART-väylän kautta.¹⁾ Signaalien käsittelyyn käytetään Process Intelligence -tekniikkaa.

Tekniset tiedot

Täydellinen erittely löytyy SITRANS LR200 (HART) -laitteen käyttöoppaasta. Hyväksynät on merkitty laitteen nimikilpeen ja prosessikilpeen.

Ympäristön lämpötilä/käyttölämpötilä

Huomautukset:

- Prosessilämpötila ja paineominaisuudet riippuvat prosessikilvessä olevista tiedoista. Kilvessä mainitun viitepiirroksen voi ladata Siemensin verkkosivuilta osoitteesta www.siemens.com/LR200.
- Maksimilämpötila riippuu prosessiliitännästä, antennin materiaaleista ja astian paineesta. Katso lisätietoja: *Prosessin maksimilämpötilakuvaaja* sivulla 22. Prosessipaineen ja -lämpötilan suhteutuskäyrät ovat oppaan laajassa versiossa.

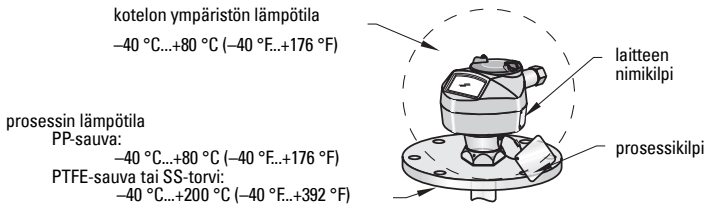

Virta



Yleiskäyttö:

Sytyttämätön (vain FM/US):

Luonnostaan vaaraton:



Tulenkestävä:

Varmennettu rakenne:

Räjähdyssuojattu (FM/CSA vain USA/Kanada):

Nimellisjännite 24 V (tasavirta) ja enintään 550 ohmin silmukkavastus.

Nimellisjännite 24 V (tasavirta) ja enintään 250 ohmin silmukkavastus.

Hyväksynät

- Yleinen CSA_{US/C}, FM, CE
- Radio Eurooppa (R&TTE), FCC, Industry Canada

(jatkuu seuraavalla sivulla)

¹⁾ HART® on HART Communication Foundationin rekisteröity tavaramerkki.

- Räjähdystvaaralliset tilat

Tulenkestävä (Eurooppa) ¹⁾	ATEX II 1/2 G, EEx dm ia IIC T4
Varmennettu rakenne (Eurooppa) ²⁾	ATEX II 1/2 G, EEx em ia IIC T4
Räjähdyssuojattu (US/Kanada) ³⁾	FM/CSA: (ei edellytä suojausta) Luokka I, jako 1, ryhmät A, B, C, D Luokka II, jako 1, ryhmät E, F, G Luokka III T4

Huomautus: Käytä asianmukaisia johdintivisteitä, jotta laitteen IP- tai NEMA-luokitus säilyy.

Hyväksynät (jatkoa)

- Räjähdystvaaralliset tilat

Syöttämätön (US) ⁴⁾	FM: (ei edellytä suojausta) Luokka I, jako 2, ryhmät A, B, C, D T5
Luonnostaan vaaraton ⁵⁾ (Eurooppa)	ATEX II 1 G, EEx ia IIC T4
(US/Kanada)	FM/CSA: (edellyttää suojausta) Luokka I, jako 1, ryhmät A, B, C, D Luokka II, jako 1, ryhmät E, F, G Luokka III T4
(Australia)	ANZEX Ex ia IIC T4 (Tamb = -40...+80 °C) IP67
(Kansainvälinen)	IECEX TSA 04.0020X T4

- Meriympäristö Lloyd's Register of Shipping
ABS-tyyppihyväksyntä

Ohjelmointilaite (infrapunänappäimistö)

Luonnostaan vaaraton Siemens Milltronics Infrared IS (Intrinsically Safe) -käsiohjelmointilaite räjähdysvaarallisia ja muita tiloja varten (paristoa ei voi vaihtaa, sen odotettu käyttöikä on 10 vuotta normaalkäytössä).

- hyväksyntä ATEX II 1 G, EEx ia IIC T4, SIRA 01ATEX2147 -sertifikaatti
FM/CSA: Luokka I, jako 1, ryhmät A, B, C, D
- ympäristön lämpötila -20...40 °C (-5...104 °F)
- liitäntä oma erityinen infrapunapulsssignaali
- virtalähde 3 V:n litiumparisto
- paino 150 g (0,3 lb)
- väri musta
- Osanro 7ML1930-1BK

1) Katso *Tulenkestävä johdotus* sivulla 9.

2) Katso *Varmennetun rakenteen johdotus* sivulla 10.

3) Katso *Räjähdyssuojattu johdotus (FM/CSA vain USA/Kanada):* sivulla 10.

4) Katso *Syöttämätön johdotus (vain FM/US)* sivulla 11.

5) Katso *Luonnostaan vaaraton johdotus* sivulla 11.

Painesovellukset



VAROITUKSET:

- Tämä laite on direktiivin 97 / 23/EY mukainen painelaite, jota ei ole suunniteltu varolaitteeksi.
- Älä yritä irrottaa, poistaa tai purkaa prosessiliitäntää tai mittarikoteloä säiliön ollessa paineistettuna.
- Virheellinen asennus saattaa aiheuttaa prosessipaineen häviämisen.

Asennus



VAROITUKSET:

- Asennuksen saa suorittaa ainoastaan asiantunteva henkilöstö ja asennuksessa on noudatettava paikallisia määräyksiä.
- Rakenneaineet valitaan yleisiin käyttötarkoituksiin niiden kemiallisen yhteensopivuuden (eli reagoimattomuuden) perusteella. Erityisympäristöille altistuvissa sovelluksissa kemiallinen yhteensopivuus on tarkistettava taulukoista ennen asennusta.

Huomautukset:

- Prosessikilpeä ei saa poistaa prosessipaineen rajapinta-asennelmasta¹⁾. Jos laitekokonaisuus vaihdetaan uuteen, prosessikilpi on siirrettävä korvaavaan yksikköön.
- SITRANS LR200 -yksiköt on testattu hydrostaattisesti, ja ne täyttävät tai ylittävät ASME Boiler and Pressure Vessel Code -säännösten ja Euroopan yhteisön painelaitedirektiivin vaatimukset.

Asennusohjeita

- Sopivassa asennuspaikassa laitteen näkee helposti ja sen voi ohjelmoida helposti käsiohjelmointilaitteella.
- Asennuspaikan on oltava laitteen kotelon luokituksen ja rakenneaineiden mukainen.
- Asenna aurinkosuoja, jos laite asennetaan suoraan auringonvalolle alttiiksi.

¹⁾ Prosessipaineen rajapinta-asennelmaan sisältyy osia, jotka estävät prosessiastian paineen purkautumista: tällä tarkoitetaan prosessiliitännän runkoa ja lähetintä mutta yleensä ei sähköiset osat sisältävää koteloa.

Säteilyaukon suunnittelu

Huomautukset

- Pituudeltaan 100 mm:n (4") suuttimissa tai lyhyemmissä on käytettävä 100 mm:n (4") suojaa.
- Pituudeltaan 250 mm:n (10") suuttimissa tai lyhyemmissä on käytettävä 250 mm:n (10") suojaa.
- Yksityiskohtaiset ohjeet muita käyttötarkoituksia varten ovat käyttöoppaan laajassa versiossa.
- Torven pään on ulotuttava vähintään 10 mm:n (0.4") päähän säteilyaukosta, jotta vältetään väärät kaiut.

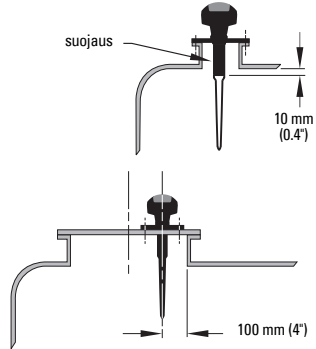

Sijainti tarkastusaukon kanssa

- Tarkastusaukon kansi on yleensä läpimitaltaan vähintään 610 mm (24") oleva katettu säteilyaukko.
- Paras signaali varmistetaan sijoittamalla antenni sivuun kannen keskipisteestä, noin 100 mm:n (4") päähän aukon reunasta.

Säteilyaukon sijoitus

VAROITUS: Yläosastaan kartiomaisissa tai parabolin muotoisissa säiliössä on vältettävä laitteen sijoittamista keskelle. (Yläosan koveruus voi keskittää kaiut keskelle ja antaa vääriä lukemia.)

Huomautus: Tietyissä olosuhteissa voidaan hyväksyä laitteen asentaminen yläosastaan tasaisen säiliön keskelle. Keskustele tästä ratkaisusta paikallisen Siemens-edustajan kanssa.

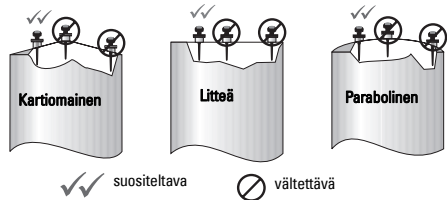

- Varmista, ettei säteilykeilan alueella ole häiritseviä tikkaita, putkia, I-tankoja eikä täyttövirtauksia.
- Sijoita antenni etäälle sivuseinästä epäsuorien kaikujen aiheuttamien häiriöiden välttämiseksi.
- Varaa tilaa säteen leviämiselle, jotta vältät häiriöt säiliön seinistä tai säiliössä olevista esteistä.

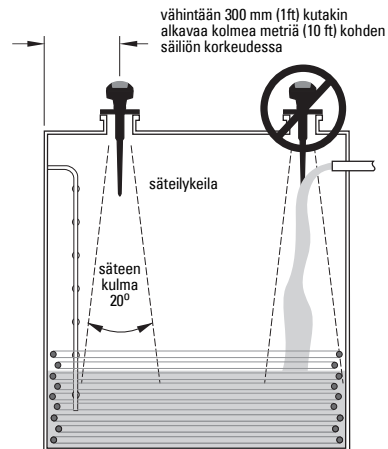

Asennusohjeet

Huomautukset

- Laitteen kiertämiskertoja ei ole rajoitettu.
- Suuntaa laitteen etu- tai takasivu kohti lähintä astian seinää.
- Älä kierrä koteloa, kun olet ohjelmoinut laitteen ja asettanut sen kokoonpanoasetukset (mittauspulssin polariteetin siirtyminen voi aiheuttaa mittausvirheitä).

Kierreversio

- 1) Ennen kuin työnnät laitteen asennusliitintäänsä, varmista, että kierteen ovat samaa tyyppiä, jotta ne eivät vahingoitu.
- 2) Kiinnitä laite prosessiliitintään kiertämällä ja kiristä käsin. Painesovelluksissa on käytettävä PTFE-nauhaa tai muuta hyväksyttyä kierretiivistettä, ja prosessiliitintä on kiristettävä koneellisesti (maks. kiristystiukkuus 40 Nm (30 ft.lbs).
- 3) Jos haluat kierrä koteloa, löysää kolme säätöruuvia, joilla lukitusrenkas on varmistettu. Kun kotelo on oikeassa asennossa, kiristä ruuvit.

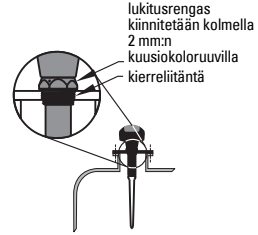

Laipallinen versio



VAROITUS: Käyttäjä vastaa laipan kiinnitys- ja tiivistemateriaaleista, käytötavasta ja huoltokelpoisuudesta.

Johdotus

Virta

VAROITUKSET:



Tasavirtaliittimiin on syötettävä virtaa virtalähteestä, jossa tulo- ja lähtöpuoli on eristetty sähköisesti toisistaan, jotta sovellettavat IEC 61010-1 -turvallisuusvaatimukset täyttyvät.



Kaikissa kenttäjohtimissa on oltava ilmoitetun jännitteen mukainen eristys.

SITRANS LR200:n kytkeminen

! VAROITUKSET:

- Tarkista laitteen nimikilvestä ja prosessikilvestä hyväksyntäluokitus.
- Käytä asianmukaisia johdintiivisteitä, jotta laitteen IP- tai NEMA-luokitus säilyy.
- Lue *Räjähdysvaarallisten tilojen asennusta koskevat ohjeet* sivulla 13.

Huomautukset:

- Katso täydelliset kytkentäohjeet käyttöoppaan laajasta versiosta.
- Käytä kierrettyjä parikaapeleita: lankamitaltaan 22–14 (0,34 mm²–2,5 mm²).
- Standardien tai sähköasetusten mukaiseen johdotukseen saatetaan tarvita erilliset kaapelit ja johtimet.

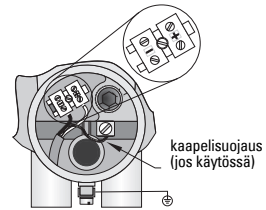
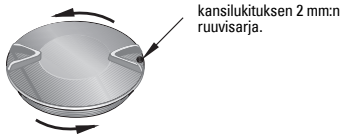

- 1) Irrota kansilukituksen ruuvit 2 mm:n kuusiokoloavaimella ja kierrä kansi auki.
- 2) Pura kaapelin vaippaa noin 70 mm:n (2,75") matkalta toisesta päästä ja pujota johdot holkin läpi.
- 3) Kytke johdot liittimiin yllä kuvatulla tavalla: napaisuus on merkitty riviliittimeen.
- 4) Maadoita laite paikallisten vaatimusten mukaisesti.
- 5) Kiristä holkki, niin että johdot lukittuvat hyvin paikoilleen.
- 6) Sulje kansi ja kiinnitä lukitus ennen ohjelmointia ja laitteen konfigurointia. Älä kierrä laitetta konfiguroinnin jälkeen, sillä se saattaa aiheuttaa virheitä.

HART-kytkentä: tyypillinen ohjelmoitavan logiikkaohjaimen mA-kokoonpano

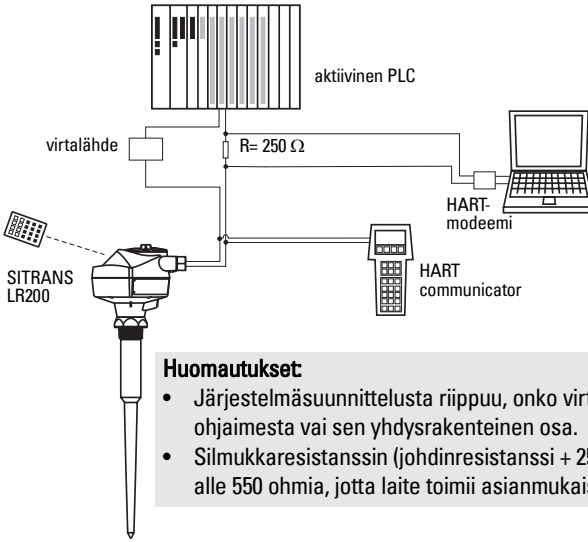

Huomautukset:

- Järjestelmäsuunnittelusta riippuu, onko virtalähde erillinen PLC-ohjaimesta vai sen yhdysrakenteinen osa.
- Silmukkaresistanssin (johdinresistanssi + 250 ohmia [vastus]) on oltava alle 550 ohmia, jotta laite toimii asianmukaisesti.

Kytkeämääritykset asennettaessa räjähdysvaarallisiin tiloihin

Huomautus: ATEX-sertifikaatit ja alla luetellut kytkentäpiirustukset voidaan ladata tuotesivulta sivustostamme osoitteesta www.siemens.com/LR200.

Räjähdyksivaarallisten tilojen asennuksia varten on viisi johdotusvaihtoehtoa. Tarkista aina laitteen nimikilvestä ja prosessikilvestä hyväksyntäluokitus.



1. Tulenkestävä johdotus

SIEMENS		II 1/2 G		HART	
SITRANS LR200	7ML1234-56789-0ABC-D	Ex	EEx dmia IIC T4	<input type="checkbox"/>	
Serial No: GYZ/S1034567	Encl.: NEMA/TYPE 4X, 6, IP67, IP68	SIRA	05ATEX1001X	<input type="checkbox"/>	Um = 250V
Amb. Temp.: -40°C to 80°C	Power Rating: 24V --- Nom., 30V --- Max., 4 - 20mA	CE	0682	<input checked="" type="checkbox"/>	
Siemens Milltronics Process Instruments Inc., Peterborough			0518	<input type="checkbox"/>	
Made in Canada					

Hyväksyntäluokka	Voimassa- oloalue:	Viite
ATEX II 1/2 G, EEx dm ia IIC T4	Eurooppa	Flameproof/Increased Safety: ATEX Certificate sivulla A-1.

- Tehontarve: katso *Käyrä 2 (Tulenkestävä, varmennettu rakenne, räjähdysuojattu)* sivulla 23.
- Noudata johdotuksessa aina paikallisia määräyksiä.
- Katso myös *Räjähdyksivaarallisten tilojen asennusta koskevat ohjeet* sivulla 13 ja edellä mainittu ATEX-sertifikaatti.



2. Varmennetun rakenteen johdotus

SIEMENS			
SITRANS LR200 7ML1234-56789-0ABC-D SerialNo: GYZ/S1034567 Encl.: NEMA/TYPE 4X, 6, IP67, IP68 Amb. Temp.: -40°C to 80°C Power Rating: 24V --- Nom. 30V --- Max. 4-20mA Siemens Milltronics Process Instruments Inc., Peterborough Made in Canada		 II 1/2 G EEx emia IIC T4 SIRA 05ATEX1001X 0682 0518	
		HART  Um = 250V	

Hyväksyntäluokka	Voimassa- oloalue:	Viite
ATEX II 1/2 G, EEx em ia IIC T4	Eurooppa	Flameproof/Increased Safety: ATEX Certificate sivulla A-1.

- Tehontarve: katso *Käyrä 2 (Tulenkestävä, varmennettu rakenne, räjähdysuojattu)* sivulla 23.
- Noudata johdotuksessa aina paikallisia määräyksiä.
- Katso myös *Räjähdystvaarallisten tilojen asennusta koskevat ohjeet* sivulla 13 ja edellä mainittu ATEX-sertifikaatti.

3. Räjähdyssuojattu johdotus (FM/CSA vain USA/Kanada):

SIEMENS			
SITRANS LR200 7ML1234-56789-0ABC-D SerialNo: GYZ/S1034567 Encl.: NEMA/TYPE 4X, 6, IP67, IP68 Amb. Temp.: -40°C to 80°C Power Rating: 24V --- Nom. 30V --- Max. 4-20mA Siemens Milltronics Process Instruments Inc., Peterborough Made in Canada		Class I: Div 1; Group A, B, C, D Class II: Div 1; Group E, F, G Class III Temp. Code: T4 Per drawing: 23650597 WARNING: Do Not Remove Cover While Circuits Are Live	
		 FCC ID: NJA-LR 200 CANADA: 267P-LR 200 HART  159134	

Hyväksyntäluokka	Voimassa- oloalue:	Viite
FM/CSA: Luokka I, jako 1, ryhmät A, B, C, D Luokka II, jako 1, ryhmät E, F, G Luokka III T4	US/Kanada	FM/CSA-räjähdyssuojattu johdotuspiirustus numero 23650597

- Tehontarve: katso *Käyrä 2 (Tulenkestävä, varmennettu rakenne, räjähdysuojattu)* sivulla 23.
- Katso (ainoastaan Pohjois-Amerikan) johdotusvaatimukset yllä mainitusta johdotuspiirustuksesta, joka voidaan ladata tuotesivulta sivustostamme osoitteesta www.siemens.com/LR200.

4. Sytyttämätön johdotus (vain FM/US)

SIEMENS	CANADA: 267P- FCC ID: NJA-LR200		Class I, Div. 2, Group A, B, C, D Temp. Code: T5
7ML1234-56789-0ABC-D Serial No: GYZ / S1034567 Encl.: NEMA / TYPE 4X, 6, IP67 Amb. Temp.: -40 °C to 80 °C Power Rating: 24V --- Nom., 30V --- Max., 4-20mA			
Siemens Millitronics Process Instruments Inc., Peterborough Made in Canada			





This device complies with Part 15 of the FCC Rules.
Operation is subject to the following two conditions
1) This device may not cause harmful interference and
2) This device must accept any interference received,
including interference that may cause undesired operation

Hyväksyntäluokka	Voimassa- oloalue:	Viite
FM: Luokka I, jako 2, ryhmät A, B, C, D, T5	USA	FM-Sytyttämätön johdotuspiirustus numero 23650537

- Tehontarve: katso *Käyrä 1 (yleiskäyttö, luonnostaan turvallinen, sytyttämätön)* sivulla 23.
- Katso (ainoastaan Pohjois-Amerikan) johdotusvaatimukset yllä mainitusta johdotuspiirustuksesta, joka voidaan ladata tuotesivulta sivustostamme osoitteesta www.siemens.com/LR200.

5. Luonnostaan vaaraton johdotus

SIEMENS	Class I, Div 1, Group A, B, C, D Class II, Div 1, Group E, F, G Class III Temp. Code: T4 HART		Class I, Div 1, Group A, B, C, D Class II, Div 1, Group E, F, G Class III Temp. Code: T4 HART	V _{max} = 30 V I _{max} = 120 mA P _{max} = 0.8 W C _i = 15 nF L _i = 0.1 mH CSA per drawing A5E01003039 FM per drawing A5E01003040 WARNING: Possible Static Hazard, Do Not Rub Or Clean On Site
SITRANS LR200 7ML1234-56789-0ABC-D Serial No: GYZ / S1034567 Encl.: NEMA / TYPE 4X, 6, IP67, IP68 Amb. Temp.: -40 °C to 80 °C Power Rating: 24V --- Nom., 30V --- Max., 4-20mA				
Siemens Millitronics Process Instruments Inc., Peterborough Made in Canada				

SIEMENS	II 1 G EEx ia IIC T4					
SITRANS LR200 7ML1234-56789-0ABC-D Serial No: GYZ / S1034567 Encl.: NEMA / TYPE 4X, 6, IP67, IP68 Amb. Temp.: -40 °C to 80 °C Power Rating: 24V --- Nom., 30V --- Max., 4-20mA						
Siemens Millitronics Process Instruments Inc., Peterborough Made in Canada						

WARNING: Possible Static Hazard, Do Not Rub Or Clean On Site.

Hyväksyntäluokka	Voimassa- oloalue:	Viite
FM/CSA: Luokka I, jako 1, ryhmät A, B, C, D Luokka II, jako 1, ryhmät E, F, G Luokka III	US/Kanada	FM-Luonnostaan vaaraton johdotuspiirustus numero A5E01003040 CSA-Luonnostaan vaaraton johdotuspiirustus numero A5E01003039
ATEX II 1 G, EEx ia IIC T4	Eurooppa	<i>Intrinsically Safe: ATEX Certificate</i> sivulla A-5
ANZEX Ex ia IIC T4 (T _{amb} = -40...80 °C) IP67	Australia	
IECEX TSA 04.0020X	Kansainvälinen	

- Tehontarve: katso *Käyrä 1 (yleiskäyttö, luonnostaan turvallinen, sytyttämätön)* sivulla 23.

- Johdotusvaatimukset:
 - P-Amerikka Katso lisätietoja yllä mainituista johdotuspiirustuksista, jotka voidaan ladata tuotesivulta sivustostamme osoitteesta www.siemens.com/LR200.
 - Eurooppa: Noudata paikallisia määräyksiä.
 - Australia: Noudata paikallisia määräyksiä.
 - Kansainvälinen: Noudata paikallisia määräyksiä.
- Käytä asianmukaisia johdintiivisteitä, jotta laitteen IP- tai NEMA-luokitus säilyy.
- Suosittelavien luonnostaan turvallisten suojarajoittimien luettelo: *Passiiviset ohitusdiodisuojarajoittimet* sivulla 12.
- Katso myös *Räjähdyksivaarallisten tilojen asennusta koskevat ohjeet* sivulla 13 ja edellä mainittu ATEX-sertifikaatti.

Huomautus: Sopivan PLC-syöttömodulin, teholähteen tai suojarajoittimen valinta edellyttää tietoja luontaisesta turvallisuudesta ja sovelluksesta. Asentajan vastuulla on varmistaa, että luonnostaan turvallinen asennus on sekä laitteen hyväksyntävaatimusten että asiaa koskevien kansallisten käytännesääntöjen mukainen.

Passiiviset ohitusdiodisuojarajoittimet

Huomautus: Tarvitaan tarkasti säädettävä virtalähde.

Valmistaja	Osanro
MTL	787SP+ (kaksikanavainen)
MTL	7787P+ (kaksikanavainen)
Stahl	9001/01-280-100-10 (yksikanavainen)
Stahl	9002/01-280-110-10 (kaksikanavainen)

Passiivisen suojarajoittimen valinta SITRANS LR200 -laitteeseen

Varmista, että suojarajoittimen kuvaus vastaa LR200:n luonnostaan turvallisen asennuksen (IS) tuloparametreja, tekemällä seuraavat laskelmat:

- Re-e = suojan enimmäisvastus päästä päähän
- Rloop = silmukkavastus (johdinresistanssi + esim. linjaresistanssi, näytöt ja/tai ohjelmoitavan logiikkaohjaimen tulot)
- Vbarrier = suojen aiheuttamien epälineaaristen jännitteenalennemien arvo

- Määritä Re-e-arvo teknisistä tiedoista.
- Laske Rloop-kokonaisarvo: lisää esimerkiksi linjaresistanssi, näytöt ja/tai ohjelmoitavan logiikkaohjaimen tulot.
- Laske Rworking = Re-e + Rloop.

- 4) Määritä suojarajoittimen V_{barrier}-arvo teknisistä tiedoista (esimerkiksi diodien aiheuttamat jännitteenalenemat).
- 5) Laske V_{working} = V_{supply} – V_{barrier}.

Vahvista V_{working}- ja R_{working}-arvoja käyttäen, että laskutoimituksen arvo sijoittuu varjostetulle alueelle kuvaajassa *Käyrä 1 (yleiskäyttö, luonnostaan turvallinen, syyttämätön)* sivulla 23.

Huomautukset:

- Seuraava luettelo ei ole tyhjentävä: markkinoilla on lukuisia luontaisesti vaarattomia virtalähteitä ja suojarajoittimia, jotka toimivat LR200 -laitteen kanssa.
- Kaikki alla luetellut PLC-syöttömoduulit ja suojarajoittimet on testattu, ja ne ovat toiminnallisesti yhteensopivia LR200:n kanssa.

Aktiiviset suojarajoittimet (toistuvatoimiset suojarajoittimet)

Valmistaja	Osanro
MTL	706
MTL	7206
Stahl	9001/51-280-110-14
Pepperl+Fuchs	KSD2-CI-S-Ex
Pepperl+Fuchs	KFD2-STC3-Ex1
MTL	E02009 - tarkista
MTL	E02010

Räjähdyksivaarallisten tilojen asennusta koskevat ohjeet (ATEX-direktiivi 94/9/EY, liite II, kohta 1/0/6)

Seuraavat ohjeet koskevat sertifikaattien SIRA 06ATEX2378X ja SIRA 05ATEX1001X mukaisia laitteita:

- 1) Käyttö- ja kokoamisohjeet ovat pääohjeissa.
- 2) Laite on sertifioitu luokan 1G laitteeksi.
- 3) Laitetta saadaan käyttää palavien kaasujen ja höyryjen yhteydessä laiteluokissa IIC, IIB ja IIA sekä lämpötilaluokissa T1, T2, T3 ja T4.
- 4) Laite on sertifioitu käytettäväksi –40 °C – +80 °C:n ympäristön lämpötilassa.
- 5) Laitetta ei ole luokiteltu direktiivin 94/9/EY liitteen II kohdan 1.5 mukaiseksi turvallisuuteen myötävaikuttavaksi laitteeksi.
- 6) Tämän laitteen saa asentaa ja tarkistaa vain koulutettu henkilö sovellettavan standardin (Euroopassa EN 60079-14 ja EN 60079-17) mukaisesti.

- 7) Laitetta ei voi korjata.
- 8) X-pääte sertifiointinumerossa tarkoittaa, että laitteen käyttöön sovelletaan turvallista käyttöä koskevia erikoisehtoja. Laitetta asentavien tai tarkastavien henkilöiden on voitava tarkistaa tarkastustodistukset.
- 9) Jos laite joutuu todennäköisesti kosketuksiin voimakkaasti reagoivien aineiden kanssa, käyttäjän on varmistettava, että kyseiset aineet eivät pääse vaikuttamaan laitteeseen ja heikentämään sen suojausta.

Voimakkaasti reagoivat aineet: esimerkiksi metalleja syövyttävät hapot ja polymeeriin vaikuttavat liuotteet.

Varoitoimet: sen tarkistaminen materiaalin teknisistä tiedoista, että materiaali kestää tiettyjä kemikaaleja.

SITRANS LR200:n aktivointi

Kytke laitteeseen virta. SITRANS LR200 käynnistyy automaattisesti mittaustilaan. (Näytön kielen vaihtaminen: katso *Luettellun vaihtoehdon valinta (esimerkiksi kielen valinta)* sivulla 17.)

Nestekidenäyttö

Mittaustila (normaali toimintatila)

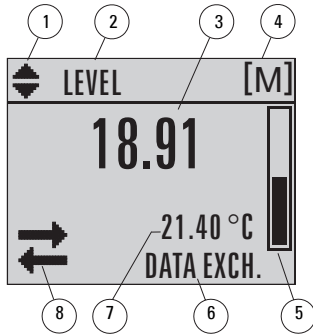

- 1 – kytkin: ilmaisimen lineaariset yksiköt tai %
- 2 – valittu toiminta: level (pinnan korkeus), space (väli) vai distance (etäisyys)
- 3 – mittausarvo (pinnan korkeus tai tilavuus, väli tai etäisyys)
- 4 – yksikkö
- 5 – pinnankorkeuden palkkikuvaaja
- 6 – toissijainen alue näyttää pyydettyä¹⁾ elektronikan lämpötilan, kaiuin luotettavuusarvon, silmukkavirran tai etäisyyden
- 7 – tekstialue näyttää tilaviestit
- 8 – laitteen tilailmaisin

Vika ilmennyt



S: 0 LOE

- 7 – tekstialue näyttää virhekoodin ja virheviestin
- 8 – huoltotarvekuvake tulee näkyviin

PROGRAM-ohjelmointitila

Navigaationäyttö

- Näkyviin tuleva valikkopalkki tarkoittaa, että valikkoluettelo on niin pitkä, etteivät kaikki kohdat näy.
- Paksumpi neliö tarkoittaa lyhyempää valikkoluetteloa.

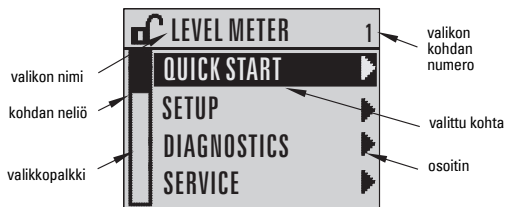

¹⁾ Näppäimen painalluksen jälkeen: katso *Painikkeiden toiminnot mittaustilassa* sivulla 15.

Parametrinäyttö

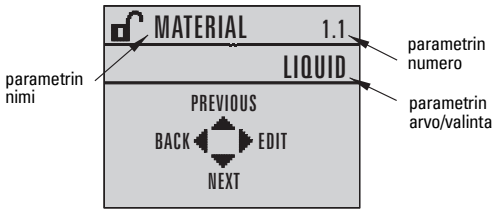

Muokkausnäyttö

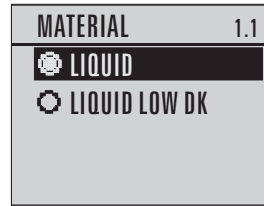

Käsiohjelmointilaite





(Osanro 7ML1930-1BK)

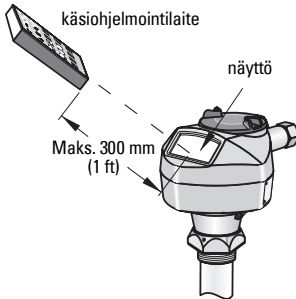



Ohjelmointilaite tilataan erikseen.

- Suuntaa ohjelmointilaite näyttöä kohti (enintään 300 mm:n [1 ft.] päästä).
- Voit vaihtaa mittaustilan ohjelmointitilaan ja päinvastoin painamalla  Mode.



Painikkeiden toiminnot mittaustilassa

Painike	Toiminto	Tulos
	Mode siirtää laitteen PROGRAM-ohjelmointitilaan.	Näyttöön tulee viimeksi tällä käyttäjaksolla näytetty valikkotasoa tai valikkotasoa 1, jos virta on sammutettu PROGRAM-ohjelmointitilasta poistumisen jälkeen tai jos PROGRAM-ohjelmointitilan käytöstä on kulunut yli 10 minuuttia.
	NUOLI oikealle siirtää PROGRAM-ohjelmointitilaan.	Avaa valikkotasoa 1.
 	Nuoli YLÖS tai ALAS vaihtaa lineaariset yksiköt %:eihin ja päinvastoin.	Nestekidenäytöllä näkyy mitattu arvo joko lineaarisina yksiköinä tai prosentteina.

Painike	Toiminto	Tulos
	Päivittää silmukavirran.	Uusi arvo näkyy nestekidenäytön toissijaisella alueella.
	Päivittää kotelon sisäisen lämpötilalukeman.	
	Päivittää kaiun luotettavuusarvon.	
	Päivittää etäisyysmittauksen.	

SITRANS LR200:n ohjelmointi

Huomautus: SITRANS LR200 palaa automaattisesti mittaustilaan, kun sitä ei ole käytetty vähään aikaan PROGRAM-ohjelmointitilassa (aika vaihtelee valikon tason mukaan 15 sekunnista 10 minuuttiin).

Asetuksia voidaan muuttaa paikallisesti paikalliskäyttöliittymästä tai etäohjauksella SIMATIC PDM:n avulla. Paikalliskäyttöliittymässä (LUI) on nestekidenäyttö ja käsiohjelmointilaitte.

- Katso *Ohjattu pikakäyttötoiminto käsiohjelmointilaitteen avulla* sivulla 18.
- Katso *Ohjattu pikakäyttötoiminto SIMATIC PDM:n avulla* sivulla 21.

Parametriverikot

Huomautus: Katso täydellinen parametriluettelo ja ohjeet käyttöoppaan laajasta versiosta. Se voidaan ladata tuotesivulta sivustostamme osoitteesta: www.siemens.com/LR200.

Parametreilla on nimi ja ne on järjestetty toimintoryhmittäin viisitasoiseksi valikkorakenteeksi.

1. QUICK START
2. SETUP
3. DIAGNOSTICS
 - 3.14. MEAS. VALUES
 - 3.14.1. CURR. INTERN. TEMP.

Parametrien haku käsiohjelmointilaitteen avulla

1. Siirry PROGRAM-ohjelmointitilaan

- a) Suuntaa ohjelmointilaitte näyttöä kohti enintään 300 mm:n (1 ft.) päästä.
- b) Avaa valikkotaso 1 painamalla **nuoli OIKEALLE** .

2. Navigointi: painikkeiden toiminnot navigaatiotilassa

Painike	Nimi	Valikon taso	Toiminto
	Nuoli YLÖS tai ALAS	valikko tai parametri	• Siirry vierittämällä edelliseen tai seuraavaan valikkoon tai parametriin.
	Nuoli OIKEALLE	valikko parametri	• Siirry valitun valikon ensimmäiseen parametriin tai avaa seuraava valikko. • Avaa muokkaustila .
	Nuoli VASEMMALLE	valikko tai parametri	• Avaa ylävalikon.
	Tila	valikko tai parametri	• Siirtää MITTAUSTILAAN .
	Home-painike	valikko tai parametri	• Avaa valikkotasoa 1.

3. Muokkaus PROGRAM-ohjelmointitilassa

Luetellun vaihtoehdon valinta (esimerkiksi kielen valinta)

- Siirry kohtaan **Language (Kieli)(7)**.
- Paina **nuoli OIKEALLE** , niin siirryt parametrinäyttöön.
- Paina **nuoli OIKEALLE** uudestaan, niin siirryt **muokkaustilaan**. Valittuna oleva vaihtoehto näkyy korostettuna.
- Vieritä uuden valinnan kohdalle. Hyväksy se painamalla **nuoli OIKEALLE** . Nestekidenäyttö palaa parametrinäyttöön ja näyttää uuden valinnan.
- Palaa valikkoon painamalla **nuoli VASEMMALLE** .

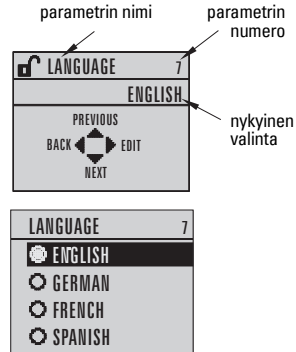

Numeroarvon muuttaminen

- Siirry haluttuun parametriin.
- Paina **nuoli OIKEALLE** , niin siirryt parametrinäyttöön. Nykyinen arvo näkyy näytössä.

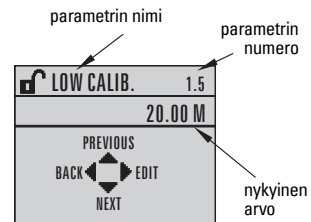





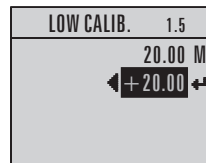

- c) Paina **nuoli OIKEALLE**  uudestaan, niin siirryt **muokkaustilaan**. Nykyinen arvo näkyy korostettuna.
- d) Syötä uusi arvo ja vahvista se painamalla **nuoli**

OIKEALLE .

Nestekidenäyttö palaa parametrinäyttöön ja näyttää uuden valinnan.





Painikkeiden toiminnot muokkaustilassa





Painike	Nimi	Toiminto
	Nuoli YLÖS tai ALAS	Vaihtoehtojen valinta <ul style="list-style-type: none"> Vierittää kohtaan.
		Numeron muokkaus <ul style="list-style-type: none"> Suurentaa tai pienentää lukua Vaihtaa plus- tai miinusmerkin
	Nuoli OIKEALLE	Vaihtoehtojen valinta <ul style="list-style-type: none"> Hyväksyy tiedot (tallentaa parametrin) Siirtää muokkaustilasta navigaatiotilaan
		Numeron muokkaus <ul style="list-style-type: none"> Siirtää kohdistinta yhden merkin oikealle tai kohdistimen ollessa Enter-merkissä hyväksyy tiedot ja vaihtaa muokkaustilasta navigaatiotilaan
	Nuoli VASEM- MALLE	Vaihtoehtojen valinta <ul style="list-style-type: none"> Peruuttaa muokkaustilan muuttamatta parametria
		Numeron muokkaus <ul style="list-style-type: none"> Siirtää kohdistimen plus-/miinusmerkkiin, jos painetaan ensimmäisenä tai siirtää kohdistimen yhden merkin vasemmalle
	Poisto	Numeron muokkaus <ul style="list-style-type: none"> Tyhjentää näytön
	Desimaalipiste	Numeron muokkaus <ul style="list-style-type: none"> Lisää desimaalipisteen
	Plus- tai miinusmerkki	Numeron muokkaus <ul style="list-style-type: none"> Muuttaa syötetyn arvon etumerkin.
	Numerot	Numeron muokkaus <ul style="list-style-type: none"> Lisää kyseisen merkin.

Ohjattu pikakäyttötoiminto käsiohjelmointilaitteen avulla

Huomautus: Kun ohjattu pikakäyttötoiminto käynnistetään, alkuasetuksiksi palautetaan aina laitteen tehdasasetukset. Aiempia käyttäjän määrittelemiä asetuksia ei voi palauttaa ohjatun toiminnon avulla.

1. Pikakäyttötoiminto

- a) Suuntaa ohjelmointilaitte näyttöä kohti (enintään 300 mm:n [1 ft.] etäisyydeltä) ja paina **nuoli OIKEALLE** , jolloin PROGRAM-tila aktivoituu ja näyttöön aukeaa valikkotaso 1.
- b) Siirry valikon kohtaan 1.1 ja avaa parametrinäyttö painamalla **nuoli OIKEALLE**  kahdesti.

- c) Paina **nuoli OIKEALLE** , jolloin **muokkaustila** tulee näyttöön, tai paina **nuoli ALAS** , jos haluat hyväksyä oletusarvot ja siirtyä suoraan seuraavaan kohtaan.
- d) Asetuksia muutetaan vierittämällä haluttuun kohtaan tai syöttämällä uusi arvo painikkeilla.
- e) Kun olet muuttanut arvoa, hyväksy se painamalla **nuoli OIKEALLE**  ja siirry seuraavaan kohtaan painamalla **nuoli ALAS** .
- f) Pikakäyttötoiminnon asetukset tulevat voimaan vasta, kun valitset **Yes (Kyllä)/Apply changes (Toteuta muutokset)** kohdassa 1.7.

1.1. Materiaali

Vaihtoehdot	LIQUID (NESTE)
	LIQUID LOW DK (neste, pieni eristevakio)

1.2. Vastenopeus

Määrittää laitteen reagointinopeuden mittaustulosten muutoksiin valitulla mittausalueella.

Vaihtoehdot	SLOW (HIDAS)	0,1 m minuutissa
	MED (KESKI)	1,0 m minuutissa
	FAST (NOPEA)	10,0 m minuutissa

Käytä asetusta, joka on hieman nopeampi kuin täytön tai tyhjentymisen enimmäisnopeus (sen mukaan, kumpi on suurempi).

1.3. Mittapään yksiköt

Valitse pikakäyttötoiminnon muuttujien (korkea ja matala kalibrointipiste sekä taso, etäisyys tai väli) yksiköt.

Vaihtoehdot	M, CM, MM, FT, IN
-------------	-------------------

1.4. Käyttö

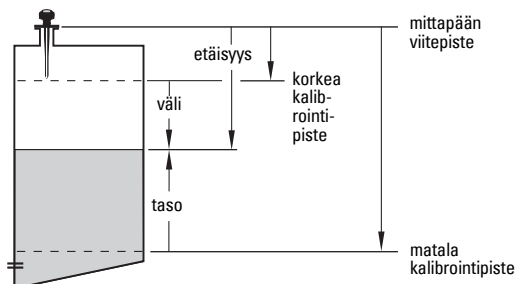

Toimintatyypit	NO SERVICE (EI TOIMINTAA)	SITRANS LR200 keskeyttää päivitysmittaukset ja niihin liittyvän silmukkavirran. Viimeksi valittu mittaus näkyy näytössä.
	LEVEL (TASO)	Etäisyys materiaalin pintaan suhteessa matalaan kalibrointipisteeseen (prosessin perustasoon).
	SPACE (VÄLI)	Etäisyys materiaalin pintaan suhteessa korkeaan kalibrointipisteeseen (prosessin täyteen tasoon).
	DISTANCE (ETÄISYYS)	Etäisyys materiaalin pintaan suhteessa mittapään viitepisteeseen.

1.5. Matala kalibrointipiste

Etäisyys mittapään viitepisteestä matalaan kalibrointipisteeseen: yleensä prosessin perustaso.

Arvot	Alue: 0,0000–20,000 m
--------------	-----------------------

1.6. Korkean kalibrointipiste

Etäisyys mittapään viitepisteestä korkeaan kalibrointipisteeseen: yleensä prosessin ylin taso.

Arvot	Alue: 0,0000–20,000 m
--------------	-----------------------

1.7. Apply? (Toteuta muutokset)

Pikakäyttöasetukset tallentuvat valitsemalla tähän kohtaan **Yes** (Kyllä).

Vaihtoehdot	YES (KYLLÄ), NO (EI)
--------------------	----------------------

Näyttöön tulee **DONE** (VALMIS), kun Quick Start -pikakäynnistysasetukset asetettu suoritettu onnistuneesti.

Palaa mittaustilaan painamalla **Mode** -painiketta. SITRANS LR200 on nyt toimintavalmis.

Kaikuprofiilin näyttö

1) Siirry PROGRAM-ohjelmointitilassa seuraavasti:

Level Meter (Tasomittari) > **Diagnostics**

(Diagnostiikka) (3) > **Echo Profile** (Kaikuprofiili) (3.1).

2) Näytä profiili painamalla **nuoli OIKEALLE** .

3) Kun olet Profiilinäytössä, painamalla **nuoli**

YLÖS  voit valita **Lähetysymbolin** ja painamalla

nuoli OIKEALLE  voit päivittää profiilin.

4) Painamalla **nuoli ALAS**  valitset **Poistu-**

kuvakkeen. Sen jälkeen **nuoli OIKEALLE** 

palauttaa edelliseen valikkoon.

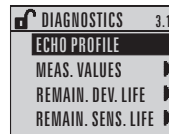

lähetyssymboli,
ei valittu

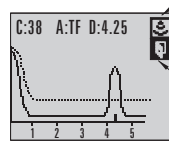

poistu-symboli,
valittu

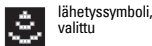

lähetyssymboli,
valittu



poistu-symboli,
ei valittu

SITRANS LR200 -viestintä: HART

- Luettelo kaikista käytettävissä olevista parametreista löytyy oppaan laajasta versiosta.
- Suosittelemme käyttämään laitteen ohjelmoinnin yhteydessä SIMATIC Process Device Manager (PDM) -ohjelmistoa.

SIMATIC PDM

Huomautukset

- Suosittelemme käyttämään SIMATIC PDM Rev. 6.0 SP3 tai uudempaa.
- SIMATIC PDM Rev. 5.2 SP1 on tuettu ainoastaan peruskokoonpanon määrittelyn ja vianmäärittelyn osalta. Ohjatun pikakäyttötoiminnon ja muiden kehittyneiden toimintojen käyttöön tarvitaan Revision 6.0 SP3 tai uudempi.

SIMATIC PDM on ohjelmistopaketti, jolla otetaan käyttöön ja kunnossapidetään SITRANS LR200:aa ja muita prosessilaitteita. Katso yksityiskohtaiset tiedot SIMATIC PDM:n käytöstä käyttöohjeista tai online-ohjeista. (Voit lukea lisätietoja osoitteesta www.siemens.com/simatic-pdm. Kohdasta **Products and Solutions** (Tuotteet ja ratkaisut) > **Products and Systems** (Tuotteet ja järjestelmät) > **Communications and Software** (Viestintä ja ohjelmistot) > **Process Device Manager** (Prosessilaittehallinta PDM).

Sähköinen laitemääritys (EDD)

- Laitemääritys löytyy laiteluettelosta (Device Catalog) kohdasta **Sensors/Level/Echo/Siemens Milltronics/SITRANS LR 200**.
- Tarkista tuotesivulta verkkosivustostamme osoitteessa www.siemens.com/LR200, kohdasta **Downloads** (*Ladattavat tiedostot*), onko Sinulla varmasti SIMATIC PDM:n uusin versio ja uusimmat Service Pack (SP) - ja hot fix (HF) -tiedostot. Jos joudut asentamaan uuden laitemäärityksen, katso *Uuden laitteen kokoonpanoasetukset* alla.

Uuden laitteen kokoonpanoasetukset

Huomautus: Vaikka napsautat **Cancel** (*Peruuta*), kun lataat tietoja laitteesta SIMATIC PDM -ohjelmistoon, osa parametreista päivittyy.

1. Tarkista, että käytössäsi on uusin tuotemääritys, ja lataa tarvittaessa uusi edellä mainitulta tuotesivulta. Tallenna tiedostot tietokoneellesi ja pura pakattu tiedosto helppopääsyiseen kansioon. Käynnistä **SIMATIC PDM – Manager Device Catalog** (*SIMATIC PDM – Hallintalaiteluettelo*), selaa puretun EDD-tiedoston kohdalle ja valitse se.
2. Käynnistä SIMATIC PDM ja luo uusi projekti laitteelle LR200. Sovellusoppaat SIMATIC PDM:n avulla määriteltäville HART-laitteille voidaan ladata tuotesivulta sivustostamme osoitteesta www.siemens.com/LR200.
3. Lataa parametrit PC/PG-laitteeseen.
4. Määritä laite ohjatun pikakäyttötoiminnon (Quick Start Wizard) avulla (katso alla).

Ohjattu pikakäyttötoiminto SIMATIC PDM:n avulla

Huomautukset:

- Ohjatun pikakäyttötoiminnon asetukset ovat sidoksissa toisiinsa, ja muutokset tulevat voimaan vasta, kun napsautat kohtaa **Transfer** (*Sirrä*) vaiheen 5 lopussa.
- Kun ohjattu pikakäyttötoiminto käynnistetään, alkuasetuksiksi palautetaan aina laitteen tehdasasetukset. Aiempia käyttäjän määrittelemiä asetuksia ei voi palauttaa ohjatun toiminnon avulla.
- Napsauta **BACK** (*TAKAISIN*), jos haluat palata taaksepäin tarkistamaan jonkin asetuksen, tai **Cancel** (*Peruuta*), jos haluat poistua Quick Start -pikakäynnistystoiminnosta.

Käynnistä SIMATIC PDM, avaa valikko **Device – Quick Start** (*Laite – Pikakäyttötoiminto*) ja noudata ohjeita vaiheissa 1–5.

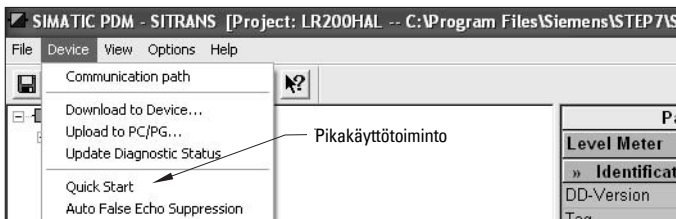

Huolto

SITRANS LR200 ei normaaleissa käyttöolosuhteissa vaadi huoltoa tai puhdistamista. Toimi seuraavasti, jos laitteen käyttö ääriolosuhteissa edellyttää sen puhdistamista:

1. Valitse puhdistusaine, joka ei vahingoita antennia eikä reagoi prosessinesteen kanssa.
2. Poista laite käytöstä ja pyyhi antenni puhtaaksi kankaalla ja sopivalla puhdistusaineella.

Laitteen korjaaminen ja vastuuvapauslauseke

Katso lisätietoja takakannen sisäsivulta.

Prosessin maksimilämpötilakuvaaja

VAROITUS: Sisälämpötila ei saa ylittää 80 °C (176 °F)-astetta!

Suurin sallittu laipan ja prosessin lämpötila suhteessa suurimpaan ympäristön lämpötilaan SITRANS LR200 -laitteen laippasovitinversioissa

- Oheinen kuvaaja on ainoastaan ohjeellinen.
- Tässä ei ole huomioitu kaikkia mahdollisia prosessiliitännämahdollisuuksia. Se EI KOSKE esimerkiksi SITRANS LR200:n asennuksia suoraan metallisen astian pintaan.
- Siinä ei huomioida myöskään suoran auringonpaisteen aiheuttamaa lämpövaikutusta.
- Parametrilla 3.14.1 voi seurata nykyistä sisälämpötilaa.

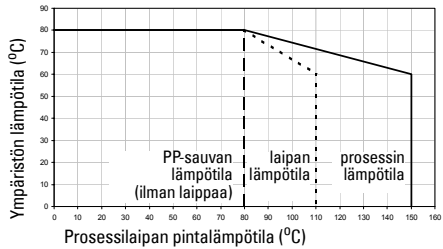

Silmukan teho

Tyypillinen kytkentäpiirustus

Huomautus: Silmukkajännite tarkoittaa jännitettä virtalähteen navoissa (eikä jännitettä laitteen navoissa).

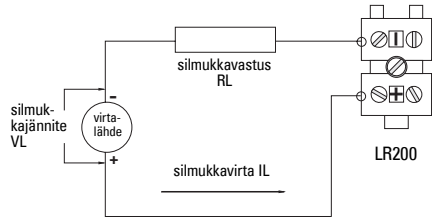

Sallittu käyttöalue

Käyrä 1 (yleiskäyttö, luonnostaan turvallinen, sytyttämätön)

Silmukkajännite vs. silmukaresistanssi

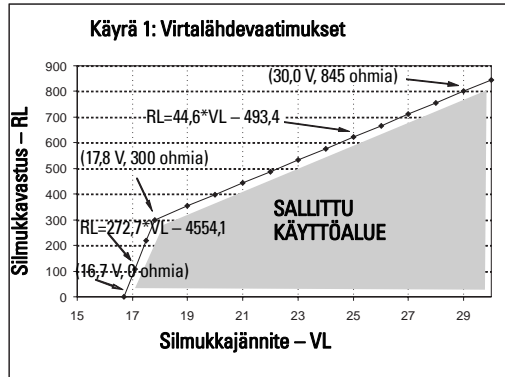

Käyrä 2 (Tulenkestävä, varmennettu rakenne, räjähdysuojattu)

Silmukkajännite vs. silmukaresistanssi

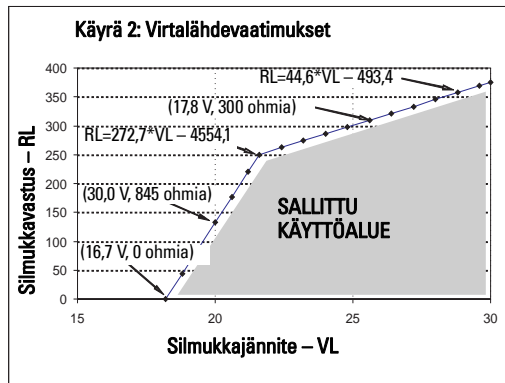

Käynnistyskäyrä

Huomautus: Laite tarvitsee käynnistymiseen 25–55 sekuntia. Vasta sen jälkeen se ilmoittaa aineen todellisen korkeustason.

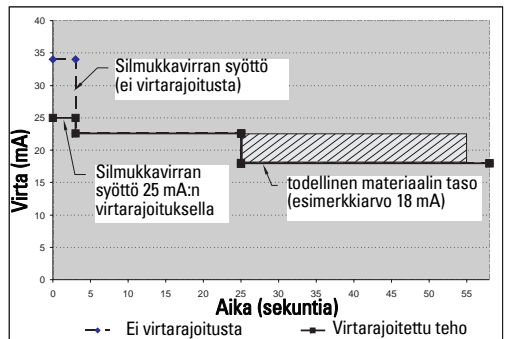

Huomautukset

SITRANS LR200 (HART) med Siemens LUI-gränssnitt: Snabbstart manual

Denna manual ger en översikt över de viktigaste egenskaperna och funktionerna hos SITRANS LR200 (HART). Vi råder er uttryckligen att skaffa er den detaljerade versionen av manualen så att ni kan få ut det mesta av ert instrument. Den kompletta manualen kan laddas ner från SITRANS LR200 produktsida på vår hemsida på: www.siemens.com/LR200. Den tryckta manualen kan anskaffas från er lokala representant för Siemens Milltronics.

Frågor angående innehållet i denna manual kan sändas till:

Siemens Milltronics Process Instruments Inc.
1954 Technology Drive, P.O. Box 4225
Peterborough, Ontario, Kanada, K9J 7B1
E-post: techpubs.smpi@siemens.com

**Copyright Siemens Milltronics
Process Instruments Inc. 2008.
Med ensamrätt**

Ansvarsbegränsning

Vi råder användare att skaffa sig auktoriserade inbundna handböcker, eller att konsultera av Siemens Milltronics Process Instruments Inc. framtagna och utgivna elektroniska versioner. Siemens Milltronics Process Instruments Inc. ansvarar inte för innehållet i ofullständiga eller kompletta kopior av inbundna eller elektroniska versioner.

Trots att vi kontrollerat att innehållet i denna handbok överensstämmer med beskriven instrumentering, kan avvikelser förekomma. Därför kan vi inte garantera full överensstämmelse. Innehållet i denna handbok revideras regelbundet och ändringar tas med i följande versioner. Vi välkomnar alla förslag till förbättringar.

Tekniska data kan komma att ändras utan föregående varsel.

MILLTRONICS är ett registrerat varumärke för Siemens Milltronics Process Instruments Inc.

Teknisk support

Support ges dygnet om.

För att hitta ert lokala Siemens Automation-kontors adress, telefonnummer och faxnummer, gå till:

www.siemens.com/automation/partner:

- Klicka på fliken **Contacts by Product** (*Kontakter genom produkt*) och sök upp produktgruppem **+Process Automation** (*Processautomation*) > **+Process Instrumentation** (*Processinstrumentering*) > **+Level Measuring Instruments** (*Nivåmätninginstrument*).
- Välj teamet **Technical Support** (*Teknisk support*). Klicka på **Next** (*Nästa*).
- Klicka på en kontinent, sedan på ett land, och sedan en stad. Klicka på **Next**.

För on-line teknisk support, gå till: www.siemens.com/automation/support-request

- För in instrumentnamnet (SITRANS LR200) eller ordernumret, och klicka sedan på **Search** (*Sök*), och välj motsvarande produkttyp. Klicka på **Next**.
- För in ett nyckelord som beskriver din fråga. Bläddra igenom motsvarande dokumentation, eller klicka på **Next** för att skicka en e-post med din fråga till Siemens Tekniska Support-stab.

Siemens A&D Technical Support Center:

tfn +49 180 50 50 222

fax +49 180 50 50 223

Riktlinjer för säkerhet

Varningsnotiser måste efterlevas för att din personliga och andras säkerhet skall kunna säkerställas samt skydda produkten och ansluten utrustning. Dessa varningsnotiser åtföljs av anvisningar om den säkerhetsnivå som skall observeras.



WARNING: berör en varningssymbol på produkten. Den innebär att underlåtenhet att efterfölja nödvändiga föreskrifter kan orsaka dödsfall, svår kroppsskada och/eller stor materiell skada.



WARNING¹⁾: innebär att underlåtenhet att efterfölja nödvändiga föreskrifter kan orsaka dödsfall, svår kroppsskada och/eller stor materiell skada.

Anmärkning: innebär viktig information om produkten eller den delen av användarmanualen.

FCC-överensstämmelse

Endast för anläggningar i USA: Regler uppställda av Federal Communications Commission (FCC)



WARNING: Ändringar eller modifikationer som inte uttryckligen godkänts av Siemens Milltronics kan upphäva användarens rätt att bruka utrustningen.

Anmärkningar:

- Denna utrustning har testats och befunnits klara de gränser som uppsatts för digital utrustning av Klass A, i enlighet med Del 15 av FCC-reglerna. Dessa gränser har satts så att skäligen skydd mot skadlig störning uppnås när utrustningen används i en industriell miljö.
- Denna utrustning genererar, använder och kan utstråla radiofrekvensenergi samt kan, om den inte installeras och används i enlighet med användarmanualen, förorsaka besvärande störningar av radiokommunikationer. Om denna utrustning används i bostadsområden uppstår förmodligen besvärande störningar på radiokommunikationerna, och användaren kan då åläggas att avhjälpa störningarna på egen bekostnad.

SITRANS LR200



WARNING: SITRANS LR200 skall endast användas på det sätt som anvisas i denna manual; i annat fall kan det skydd, som utrustningen erbjuder, visa sig otillräckligt.

Anmärkning: Denna produkt är avsedd för användning i industriområden. Drift av denna utrustning i ett bostadsområde kan förorsaka störningar av flera frekvensbaserade kommunikationer.

SITRANS LR200 är en 2-trådars 6 GHz puls radarnivåtransmitter för kontinuerlig övervakning av vätskor och slurryn i förvaringstankar vid högt tryck och hög temperatur, upp till 20 m (66 ft).

Anordningen består av en elektronisk krets kopplad till antennen och antingen en gängad eller flänsad processanslutning.

¹⁾ Denna symbol används när det inte finns någon motsvarande varningssymbol på produkten.

Kommunikation sker via HART¹⁾ Signaler bearbetas med hjälp av Process Intelligence.

Specifikationer

För fullständig lista, var god se SITRANS LR200 (HART) Användarmanual. För Godkännandeinformation, se instrumentets märkskylt och processbricka.

Omgivnings- och drifttemperatur

Anmärkningar:

- Processtemperatur och tryckkapacitet står angivna på processbrickan. Referensritningen som anges på brickan kan laddas ner från Siemens hemsida på: <https://pia.khe.siemens.com/index.asp?Nr=7427>.
- Maximal temperatur beror på processanslutningen, antennmaterialen och behållartrycket. Se *Tabell över maximala processtemperaturer* på sida 22, för närmare detaljer. Processens Tryck-Temperaturavgivningskurvor finns tillgängliga i den kompletta manualen.

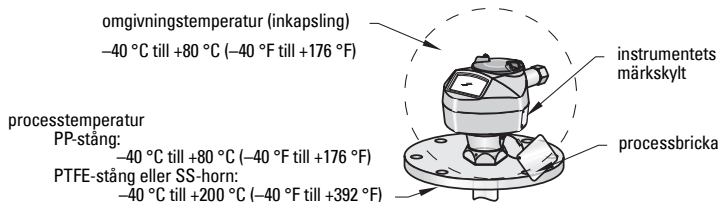

Effektförbrukning



Allmänt syfte:

Ikke antændlig (endast FM/USA):

Egensäker:



Flamsäker:

Förhöjd säkerhet:

Explosionssäker (FM/CSA endast USA/Kanada):

Nominell 24 V DC vid
max 550 Ohm
kretsresistans.

Nominell 24 V DC vid
max 250 Ohm
kretsresistans.

Godkännanden

- Allmänt CSA_{US/C}, FM, CE
- Radio: Europa (R&TTE), FCC, Industry Canada

(forts. på nästa sida)

¹⁾ HART[®] är ett registrerat varumärke för HART Communications Foundation.

- Riskfylld Flamsäker (Europa)¹⁾ ATEX II 1/2 G, EEx dm ia IIC T4
Förhöjd säkerhet (Europa)²⁾ ATEX II 1/2 G, EEx em ia IIC T4
Explosionssäker (USA/Kanada)³⁾ FM/CSA: (barriär krävs ej)
Klass I, Div. 1, Grupperna A, B, C, D
Klass II, Div. 1, Grupperna E, F, G
Klass III T4

Anmärkning: Använd lämpliga ledningstätningar för att upprätthålla IP- eller NEMA-klassning.

Godkännanden (forts.)

- Riskfylld
 - Icke-antändlig (USA)⁴⁾ FM: (barriär krävs ej)
Klass I, Div. 2, Grupperna A, B, C, D T5
 - Egensäker⁵⁾
 - (Europa) ATEX II 1 G, EEx ia IIC T4
 - (USA/Kanada) FM/CSA: (barriär krävs)
Klass I, Div. 1, Grupperna A, B, C, D
Klass II, Div. 1, Grupperna E, F, G
Klass III T4
 - (Australien) ANZEX Ex ia IIC T4
(Tomg = -40 till +80 °C) IP67
 - (Internationell) IECEx TSA 04.0020X T4
- Marin Lloyd's Register
ABS Typgodkännande

Programmeringsenhet (infraröd knappsats)

Siemens Milltronics Infraröd IS (Intrinsically Safe/Fullständigt säker)

Handprogrammeringsenhet för riskfyllda och alla andra miljöer (batteri är icke-utbytbar med en förväntad livslängd på 10 år vid normal användning).

- godkännande ATEX II 1 G, EEx ia IIC T4, intyg SIRA 01ATEX2147
FM/CSA: Klass I, Div. 1, Grupperna A, B, C, D
- omgivningstemperatur -20 till 40 °C (-5 till 104 °F)
- gränssnitt ägarskyddad infraröd pulssignal
- strömförsörjning 3 V litiumbatteri
- vikt 150 g (0,3 lb)
- färg svart
- Artikelnummer 7ML1930-1BK

¹⁾ Se *Flamsäker kabeldragning* på sida 9

²⁾ Se *Förhöjd säkerhetskabeldragning* på sida 10

³⁾ Se *Explosionssäker (FM/CSA endast USA/Kanada)* på sida 10

⁴⁾ Se *Icke antändlig kabeldragning (endast FM/USA)* på sida 11

⁵⁾ Se *Egensäker kabeldragning* på sida 11

Användning under tryck



- **VARNINGAR:**
- Denna produkt klassas som ett Trycktillbehör enligt Direktiv 97 / 23 / EC och är inte avsedd för att användas som säkerhetsanordning.
- Försök inte att lossa, ta bort eller ta isär processanslutningen eller instrumenthöljet medan innehållet i behållaren står under tryck.
- Felaktig installation kan orsaka bortfall av processtryck.

Installation



- **Varningar:**
- Installation får endast utföras av kompetent personal och enligt gällande lokala bestämmelser.
- Konstruktionsmaterial väljs på basis av dess kemiska kompatibilitet (eller låga reaktionsbenägenhet) för allmänna ändamål. För exponering mot specifika miljöer, kontrollera mot kemiska kompatibilitetstabeller före installation.

Anmärkningar:

- Processbrickan skall sitta kvar på tryckgränsheten¹⁾. Om instrumentpaketet byts, skall Processbrickan sättas över på utbytesenheten.
- SITRANS LR200-enheter är hydrostatiskt testade, och uppfyller eller överskrider alla krav i pann- och tryckkärlslagen "ASME Boiler and Pressure Vessel Code" och det Europeiska direktivet för tryckkärl.

Installationsriktlinjer

- Tillgodose lätt åtkomlighet för visning av displayen och programmering via handprogrammeringsenheten.
- Ombesörj en miljö som lämpar sig för höljets skyddsklass och konstruktionsmaterialen.
- Sätt in en solskärm om instrumentet skall monteras i direkt solljus.

¹⁾ Tryckgränsheten innehåller komponenter som fungerar som en barriär mot tryckförluster från processbehållaren: d.v.s. kombinationen av processanslutningskropp och sändare, men normalt exklusive elektrisk inkapsling.

Munstycksutformning

Anmärkningar:

- För munstycken 100 mm (4") längd eller kortare, använd 100 mm (4") skärmen.
- För munstycken 250 mm (10") längd eller kortare, använd 250 mm (10") skärmen.
- För detaljerade instruktioner rörande andra tillämpningar, se den fullständiga manualen.
- Änden på skärmsektionen måste sticka ut minst 10 mm (0.4") för att undvika att falska ekon reflekteras från munstycket.

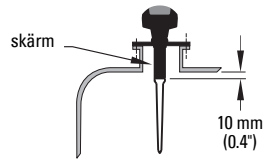

Placering på en manlucka

- En manlucka är vanligen ett täckt munstycke med en diameter 610 mm (24") eller större.
- För optimala signalförhållanden, lokalisera antennens centrumförskjutning, vanligen 100 mm (4") från sidan.

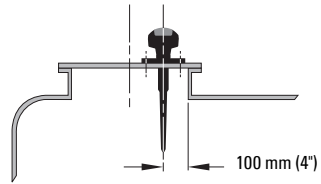

Munstycksplacering

! WARNING: För behållare med koniska eller paraboliska toppar, undvik montering av instrumentet i centrum. (Konkaviteten på toppen kan fokusera ekon i centrum, som ger felaktiga avläsningar.)

Anmärkning: Under vissa omständigheter kan det vara acceptabelt att montera instrumentet i centrum på en tank med platt topp. Diskutera detta med er lokala Siemens-representant.

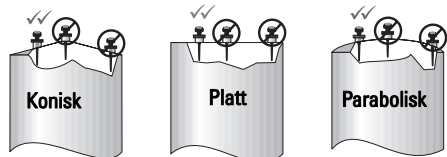

- Håll emissionskonan fri från störningar från stegar, rör, I-balkar eller fyllningsströmmar.
- Installera antennen skild från sidoväggen för att undvika störning från indirekta ekon.
- Lämna plats för emissionskonans vidgning, för att undvika störning med tankväggar eller hinder.

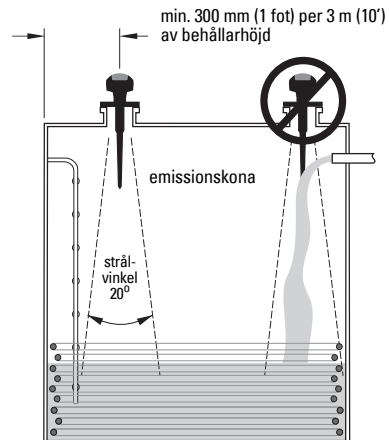

Installationsanvisningar

Anmärkningar:

- Det finns ingen gräns för hur många gånger instrumentet kan roteras.
- Orientera instrumentets fram- eller baksida mot den närmaste behållarväggen.
- Roterar inte kapslingen efter programmering och instrumentkonfiguration (en polaritetsändring av sändningspulsen kan föranleda ett fel).

Gängad version

- 1) Innan instrumentet sätts in i sin fattning, kontrollera att gängorna passar ihop så att de inte skadas.
- 2) Skruva in instrumentet i processanslutningen och dra åt för hand. För trycktillämpningar, använd PTFE-tejp eller annat lämpligt gängtätningemedel och dra åt processanslutningen så mycket att det inte går att vrida ur den för hand (max åtdragningsmoment 40 Nm (30 ft.lbs)).
- 3) För att rotera kapslingen, lossa först de tre ställskruvarna som håller låsringen. Efter positionering av kapslingen, dra åt skruvarna igen.

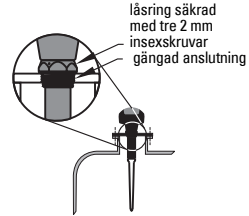

Flänsad version

! **WARNING:** Användaren är ansvarig för val av material i skruvförband och packningar som skall hålla sig inom flänsens gränsvärden och passa för dess avsedda användning och rådande driftförhållanden.

Kabeldragning

Effekt

Varningar:



DC-ingångarna skall komma från en källa som ger elektrisk isolering mellan ingång och utgång, för att uppfylla tillämpliga säkerhetskrav i IEC 61010-1.



Allt fältkablage måste ha isolering lämpad för märkspänningarna.

Anslutning av SITRANS LR200

! VARNINGAR:

- Kontrollera på instrumentets märkskylt och processbricka, att värdena är riktiga.
- Använd lämpliga ledningstätningar för att upprätthålla IP- eller NEMA-klassning.
- Läs *Instruktioner gällande installationer i farliga områden* på sida 13.

Anmärkningar:

- För detaljerade kabeldragningsinstruktioner, var god studera den fullständiga manualen.
- Använd partvinnad kabel: AWG 22 till 14 (0,34 mm² till 2,5 mm²).
- Separata kablar och kabelkanaler kan krävas för att uppfylla standardiserad kabeldragningspraxis, eller elbestämmelser.

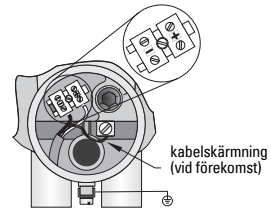
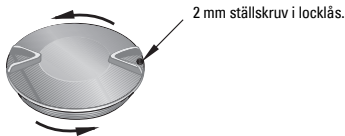

- 1) Använd en 2 mm insexnyckel för att lossa locklåsets ställskruv och skruva av locket.
- 2) Stripa kabelisoleringen över ungefär 70 mm (2,75") från änden på kabeln och trä ledningarna genom packboxen.
- 3) Anslut ledningarna till plinten så som visas: polariteten finns angiven på plinten.
- 4) Jorda instrumentet i enlighet med lokala bestämmelser.
- 5) Dra åt packboxen så att den tätar ordentligt.
- 6) Stäng locket och säkra låsringen före programmering och konfiguration. Rotera inte instrumentet efter att det konfigurerats, eftersom det kan försaka ett fel.

Anslutning av HART vanlig PLC/mA-konfiguration

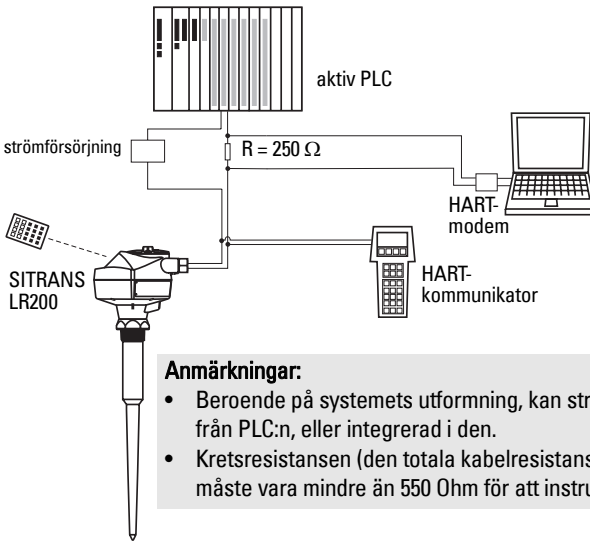

Anmärkningsar:

- Beroende på systemets utformning, kan strömförsörjningen vara skild från PLC:n, eller integrerad i den.
- Kretsresistansen (den totala kabelresistansen plus 250 Ohm [resistor]) måste vara mindre än 550 Ohm för att instrumentet skall fungera riktigt.

Kabeldragningar för installationer i farligt område

Anmärkning: ATEX-intyg och anslutningsritningar listade nedan kan laddas ner från produktsidan på vår hemsida på: www.siemens.com/LR200.

Det finns fem kabeldragningsalternativ för installationer i farligt område. Kontrollera alltid på apparatens märkskylt och processbricka, att värdena är riktiga.



1. Flamsäker kabeldragning

SIEMENS		II 1/2 G		HART	
SITRANS LR200		EEx dmia IIC T4		Um = 250V	
7ML1234-56789-0ABC-D		SIRA 05ATEX1001X		0682	
Serial No: GYZ/S1034567		0518		0518	
Encl.: NEMA/TYPER 4X, 6, IP67, IP68		CE		Ⓢ	
Amb. Temp.: -40°C to 80°C		⚠			
Power Rating: 24V === Norm., 30V === Max., 4-20mA					
Siemens Milltronics Process Instruments Inc., Peterborough					
Made in Canada					

Nominella värden	Gäller för:	Referens
ATEX II 1/2 G, EEx dm ia IIC T4	Europa	Flameproof/Increased Safety: ATEX Certificate på sida A-1.

- För effektbehov se *Kurva 2 (Flamsäker, Förhöjd säkerhet, Explosionssäker)* på sida 23.
- För kabeldragningskrav, följ lokala bestämmelser.
- Se även *Instruktioner gällande installationer i farliga områden* på sida 13 och ATEX-intyg listade ovan.



2. Förhöjd säkerhetskabeldragning

SIEMENS		 II 1/2 G EEx emia IIC T4 SIRA 05ATEX1001X 0682 0518	HART  Um = 250V
SITRANS LR200 7ML1234-56789-0ABC-D SerialNo: GYZ/S1034567 Encl.: NEMA/TYPE 4X, 6, IP67, IP68 Amb. Temp.: -40°C to 80°C Power Rating: 24V --- Nom., 30V --- Max., 4-20mA Siemens Milltronics Process Instruments Inc., Peterborough Made in Canada			

Nominella värden	Gäller för:	Referens
ATEX II 1/2 G, EEx em ia IIC T4	Europa	<i>Flameproof/Increased Safety: ATEX Certificate</i> på sida A-1.

- För effektbehov se *Kurva 2 (Flamsäker, Förhöjd säkerhet, Explosionssäker)* på sida 23.
- För kabeldragningskrav, följ lokala bestämmelser.
- Se även *Instruktioner gällande installationer i farliga områden* på sida 13 och ATEX-intyg listat ovan.

3. Explosionssäker (FM/CSA endast USA/Kanada)



SIEMENS		 Class I, Div 1; Group A, B, C, D Class II, Div 1; Group E, F, G Class III Temp. Code: T4 Per drawing: 23650597	 FCC ID: NJA-LR 200 CANADA: 267P-LR 200 HART  159134
SITRANS LR200 7ML1234-56789-0ABC-D SerialNo: GYZ/S1034567 Encl.: NEMA/TYPE 4X, 6, IP67, IP68 Amb. Temp.: -40°C to 80°C Power Rating: 24V --- Nom., 30V --- Max., 4-20mA Siemens Milltronics Process Instruments Inc., Peterborough Made in Canada			

WARNING: Do Not Remove Cover While Circuits Are Live

Nominella värden	Gäller för:	Referens
FM/CSA: Klass I, Div. 1, Grupperna A, B, C, D Klass II, Div. 1, Grupperna E, F, G Klass III T4	USA/Kanada	FM/CSA Explosionssäker anslutning ritning nummer 23650597

- För effektbehov se *Kurva 2 (Flamsäker, Förhöjd säkerhet, Explosionssäker)* på sida 23.
- Beträffande kabeldragningskrav (Endast Nordamerika) se anslutningsritningen listad ovan, som kan laddas ner från produktsidan på vår hemsida på:
www.siemens.com/LR200.





4. Icke antändlig kabeldragning (endast FM/USA)

SIEMENS	CANADA: 267P- FCC ID: NJA-LR200		Class I, Div. 2, Group A, B, C, D Temp. Code: T5
7ML1234-56789-0ABC-D Serial No: GYZ / S1034567 Encl.: NEMA / TYPE 4X, 6, IP67 Amb. Temp.: -40 °C to 80 °C Power Rating: 24V --- Nom., 30V --- Max., 4-20mA Siemens Milltronics Process Instruments Inc., Peterborough Made in Canada		This device complies with Part 15 of the FCC Rules. Operation is subject to the following two conditions 1) This device may not cause harmful interference and 2) This device must accept any interference received, including interference that may cause undesired operation	

Nominella värden	Gäller för:	Referens
FM: Klass I, Div. 2, Grupperna A, B, C, D T5	USA	FM Icke antändlig anslutning ritning nummer 23650537

- För effektbehov se *Kurva 1 (Allmänt syfte, Egensäker, Icke antändlig)* på sida 23.
- Beträffande kabeldragningskrav (Endast Nordamerika) se anslutningsritningen listad ovan, som kan laddas ner från produktsidan på vår hemsida på: www.siemens.com/LR200.

5. Egensäker kabeldragning

SIEMENS	Class I, Div 1, Group A, B, C, D Class II, Div 1, Group E, F, G Class III Temp. Code: T4 HART  CSA per drawing A5E01003039 FM per drawing A5E01003040 WARNING: Possible Static Hazard, Do Not Rub Or Clean On Site		Vmax = 30 V Imax = 120 mA Pmax = 0.8 W Ci = 15 nF Li = 0.1 mH IECEx TSA 04.0020X ANZEx 04.3016X Ex ia IIC T4 
SITRANS LR200 7ML1234-56789-0ABC-D Serial No: GYZ / S1034567 Encl.: NEMA / TYPE 4X, 6, IP67, IP68 Amb. Temp.: -40 °C to 80 °C Power Rating: 24V --- Nom., 30V --- Max., 4-20mA Siemens Milltronics Process Instruments Inc., Peterborough Made in Canada		Ii = 30 V Ii = 120 mA Pi = 0.8 W Ci = 15 nF Li = 0.1 mH HART 5.8 GHz N117 WARNING: Possible Static Hazard, Do Not Rub Or Clean On Site.	

Nominella värden	Gäller för:	Referens
FM/CSA: Klass I, Div. 1, Grupperna A, B, C, D Klass II, Div. 1, Grupperna E, F, G Klass III	USA/Kanada	FM Egensäker anslutning ritning nummer A5E01003040 CSA Egensäker anslutning ritning nummer A5E01003039
ATEX II 1 G, EEx ia IIC T4	Europa	<i>Intrinsically Safe: ATEX Certificate</i> på sida A-5
ANZEX Ex ia IIC T4 (Tomg = -40 till 80 °C) IP67	Australien	
IECEX TSA 04.0020X	Internationell	

- För effektbehov se *Kurva 1 (Allmänt syfte, Egensäker, Icke antändlig)* på sida 23.

- För kabeldragningskrav:
 - N. Amerika: Se anslutningsritningen listad ovan, som kan laddas ner från produktsidan på vår webbsajt på: www.siemens.com/LR200.
 - Europa: Följ lokala bestämmelser.
 - Australien: Följ lokala bestämmelser.
 - Internationellt: Följ lokala bestämmelser.
- Använd lämpliga ledningstätningar för att upprätthålla IP- eller NEMA-klassning.
- Rekommenderade barriärer med förhöjd säkerhet listas på *Diodbarriärer med passiv shunt* på sida 12.
- Se *Instruktioner gällande installationer i farliga områden* på sida 13 och ATEX-intyget listade ovan.

Anmärkning: För att kunna välja en PLC-inmatningsmodul, strömförsörjning, eller barriär krävs kunskap om egensäkerhet och tillämpningen. Det åligger installatören att säkerställa att installationen med egensäkerhet uppfyller både instrumentets godkännandekrav och gällande nationell praxis.

Diodbarriärer med passiv shunt

Anmärkning: Det krävs en välreglerad matarspänning.

Tillverkare	Artikelnummer
MTL	787SP+ (Dubbelkanal)
MTL	7787P+ (Dubbelkanal)
Stahl	9001/01-280-100-10 (Enkelkanal)
Stahl	9002/01-280-110-10 (Dubbelkanal)

Hur man väljer en passiv barriär för SITRANS LR200

För att säkerställa att barriärens säkerhetsbeskrivning lämpar sig för ingångsparametrarna i LR200 Intrinsically Safe (IS), skall följande beräkningar utföras:

- Re-e = max. ände-till-ände-resistans i barriären
- Rkrets = kretsresistans (total kabelresistans plus t.ex. avkänningsresistans, displayer och/eller PLC-ingångar)
- Vbarriär = värde på varje icke-linjärt spänningsfall på grund av barriären

- 1) Bestäm värdet på Re-e från databladet.
- 2) Beräkna det totala värdet för Rkrets: genom tillägg av till exempel, avkänningsresistans, displayer, och/eller PLC-ingångar.
- 3) Beräkna Rarbetande = Re-e + Rkrets.

- 4) Bestäm värdet på Vbarriär från barriärdatabladet (t.ex. spänningsfall på grund av dioder).
- 5) Beräkna Varbetande = Vförsörjning – Vbarriär.

Använd värdena för Varbetande Rarbetande för att bekräfta att operationen ligger inom det skuggade området i diagrammet *Kurva 1 (Allmänt syfte, Egensäker, Icke antändlig)* på sida 23

Anmärkningar:

- Följande lista är inte fullständig: det finns många IS-strömförsörjningar (med förhöjd säkerhet) och barriärer på marknaden, som fungerar med LR200.
- PLC-inmatningsmodulerna och barriärerna som listas nedan har alla testats och är funktionellt kompatibla med LR200.

Aktiva barrärer (upprepande barriärer)

Tillverkare	Artikelnummer
MTL	706
MTL	7206
Stahl	9001/51-280-110-14
Pepperl+Fuchs	KSD2-CI-S-Ex
Pepperl+Fuchs	KFD2-STC3-Ex1
MTL	E02009 - kontrollera
MTL	E02010

Instruktioner gällande installationer i farliga områden (Referens Europeiska ATEX-direktivet 94/9/EC, Bilaga II, 1/0/6)

Följande instruktioner är tillämpliga på utrustning som täcks av intyg nummer SIRA 06ATEX2378X, SIRA 05ATEX1001X:

- 1) För all användning och montering, se huvudinstruktionerna.
- 2) Utrustningen är certifierad för användning i Kategori 1G.
- 3) Utrustningen kan användas med eldfarliga gaser och ångor med apparater i grupperna IIC, IIB och IIA och temperaturklasser T1, T2, T3 och T4.
- 4) Utrustningen är certifierad för användning i omgivningstemperaturer från –40 °C till +80 °C.
- 5) Utrustningen har inte bedömts som en säkerhetsrelaterad utrustning (enligt meningen i direktiv 94/9/EC Bilaga II, klausul 1.5).
- 6) Installation och inspektion av denna utrustning skall utföras av lämpligt utbildad personal i enlighet med tillämpliga delar av arbetspraxis (EN 60079-14 och EN 60079-17 i Europa).

- 7) Utrustningen kan inte repareras.
- 8) Certifikatnumren har ett 'X'-suffix, som anger att speciella villkor för säker användning gäller. De som installerar eller inspekterar denna utrustning måste ha tillgång till intygen.
- 9) Om utrustningen riskerar komma i kontakt med frätande ämnen åligger det användaren att vidta lämpliga åtgärder för att förhindra att utrustningen påverkas negativt och på så vis säkerställa att skyddsgraden räcker till.

Frätande ämnen:

t.ex. sura vätskor eller gaser som kan angripa metaller, eller lösningsmedel som kan påverka polymermaterial.

Lämpliga försiktighetsåtgärder:

t.ex. att med ledning av materialets datablad kontrollera att det är beständigt mot vissa kemikalier.

Aktivering av SITRANS LR200

Inkoppling av instrumentet på elnätet. SITRANS LR200 startar automatiskt i Mätningläget. (För att ändra det visade språket, se *Val av ett listat alternativ (t.ex. val av ett språk)* på sida 17.)

LCD-displayen

Mätningläge (normal drift)

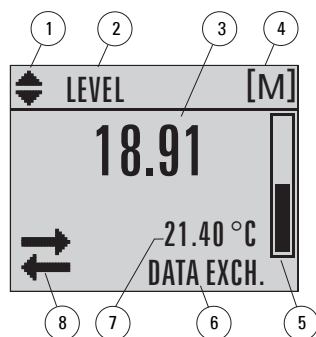

1 – vippindikator för linjära enheter eller %

2 – vald funktion: level (*nivå*), space (*rymd*), eller distance (*avstånd*)

3 – uppmätt värde (nivå eller volym, rymd eller avstånd)

4 – enheter

5 – stapeldiagram indikerar nivå

6 – sekundärt område indikerar på begäran¹⁾ elektroniktemperatur, ekotillförlitlighet, kretsström eller avstånd

7 – textyta visar statusmeddelanden

8 – instrumentstatusindikator

Fel föreligger



S: 0 LOE

7 – textyta visar en felkod och ett felmeddelande

8 – service krävs-ikon visas

PROGRAM-läge

Menyruta Navigation

- En synlig menystapel indikerar att menylistan är för lång för att kunna visa alla positioner.
- Ett djupare band betyder en kortare menylista.

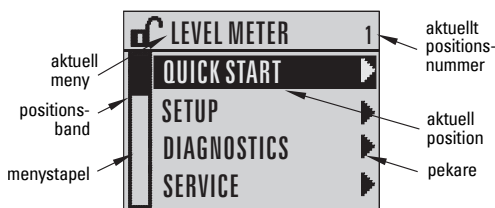

¹⁾ Som svar på en tangenttryckning: se *Knappfunktioner i Mätläge* på sida 15.

Menyruta Parametrar

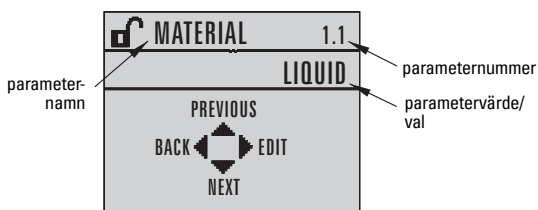

Menyruta Redigering

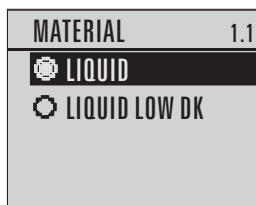

Handhållen programmeringsenhet





(Art-nr 7ML1930-1BK)

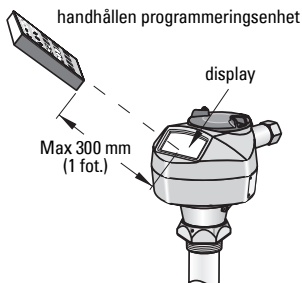



Programmeringsenheten beställs separat.

- Rikta programmeringsenheten mot displayen (från ett maximalt avstånd på 300 mm [1 fot.]).
- Tryck in  Mode (Läge) för att växla mellan Mättnings- och Programläge.



Knappfunktioner i Mätläge

Tangent	Funktion	Resultat
	Läge öppnar PROGRAM-läge.	Öppnar den senast visade menyvån i denna effektcykel, eller menyvån 1 om ström har cirkulerat efter utgång ur PROGRAM-läge eller mer än 10 minuter har gått sedan PROGRAM-läge användes.
	HÖGER pil öppnar PROGRAM-läge.	Öppnar menyläge 1.
 	UPP eller NER-pil växlar mellan linjära enheter och procent	LCD visar uppmätt värde i antingen linjära enheter eller procent.

Tangent	Funktion	Resultat
	Uppdaterar kretsströmmen.	Nytt värde visas i LCD:ns sekundära område.
	Uppdaterar inre kapslings temperaturavläsning.	
	Uppdaterar ekokonfidensvärde.	
	Uppdaterar distansmätning.	

Programmering SITRANS LR200

Anmärkning: SITRANS LR200 återgår automatiskt till Mätläge efter en inaktivitetsperiod i PROGRAM-läge (mellan 15 sekunder och 10 minuter, beroende på menynivå).

Inställningar kan ändras lokalt med det Lokala användargränssnittet eller fjärrstyrt via SIMATIC PDM. Det Lokala användargränssnittet (LUI) består av en LCD-display och en handhållen programmeringsenhet.

- Se *Snabbstartsvägledning via den handhållna programmeringsenheten* på sida 18
- Se *Snabbstartsvägledning via SIMATIC PDM* på sida 21.

Parametermenyer

Anmärkning: För den kompletta parameterlistan med instruktioner, se den kompletta manualen. Den kan laddas ner från produktsidan på vår hemsida på: www.siemens.com/LR200.

Parametrar identifieras med namn och inordnas i funktionsgrupper, och indelas sedan i en menystruktur med 5 nivåer.

1. QUICK START

2. SETUP

3. DIAGNOSTICS

3.14. MEAS. VALUES

3.14.1. CURR. INTERN. TEMP.

Åtkomst av parametrar via den handhållna programmeringsenheten

1. Gå in i PROGRAM-läge

- Rikta programmeringsenheten mot displayen från ett maximalt avstånd på 300 mm (1 fot.).
- Tryck på **HÖGER-pil**  för att öppna menyruta nivå 1.

2. Navigering: knappfunktioner i arbetsläge Navigation

Tangent	Namn	Menynivå	Funktion
	UPP eller NER-pil	meny eller parameter	<ul style="list-style-type: none"> Rulla till föregående eller nästa meny eller parameter.
	HÖGER-pil	meny	<ul style="list-style-type: none"> Gå till första parameter i den valda menyn eller öppna nästa meny
		parameter	<ul style="list-style-type: none"> Öppna läge Edit (<i>Redigering</i>).
	VÄNSTER-pil	meny eller parameter	<ul style="list-style-type: none"> Visa modermeny.
	Läge	meny eller parameter	<ul style="list-style-type: none"> Byt till MÄTNINGSLÄGE.
	Hem	meny eller parameter	<ul style="list-style-type: none"> Öppna menynivå 1.

3. Redigering i PROGRAM-läge

Val av ett listat alternativ (t.ex. val av ett språk)

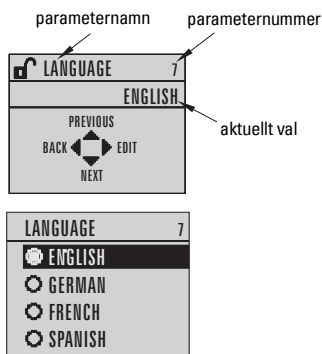

- Navigera till **Language** (*Språk*) (7).
- Tryck på **HÖGER-pil** för att öppna menyruta parametrar.
- Tryck på **HÖGER-pil** igen för att öppna **Redigeringsläge**. Det aktuella valet är upplyst.
- Rulla till ett nytt val.
Tryck in **HÖGER-pil** för att acceptera det. LCD:n återgår till menyruta parametrar och visar det nya valet.
- Tryck in **VÄNSTER-pil** för att återgå till menyn.



Ändring av ett numeriskt värde

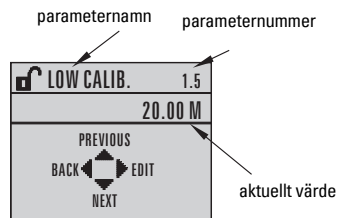





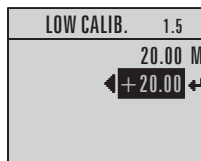

- Navigera till den önskade parametern.
- Tryck på **HÖGER-pil** för att öppna parametermeny. Det aktuella värdet visas.



- c) Tryck på **HÖGER-pil**  igen för att öppna **Redigeringsläge**. Det aktuella värdet är upplyst.
- d) Skriv in ett nytt värde och tryck på **HÖGER-pil**  för att acceptera det.
- LCD:n återgår till menyruta parametrar och visar det nya valet.





Tangentfunktioner i Redigeringsläge

Tangent	Namn	Funktion
 	UPP eller NER-pil	Val av alternativ • Rullar till position Numerisk redigering • Inkrementerar eller dekrementerar siffror • Växlar plus/minus-tecken
	HÖGER-pil	Val av alternativ • Accepterar data (skriver parametern) • Ändrar från Redigerings- till Navigations-läge Numerisk redigering • Flyttar markör ett steg åt höger • eller med markör på Enter tecknet, accepterar data och ändrar från Redigerings- till Navigations-läge
	VÄNSTER-pil	Val av alternativ • Upphäver Redigeringsläge utan att ändra parametern Numerisk redigering • Flyttar markören till plus/minus -tecken om det är den först intryckta tangenten • eller flyttar markören ett steg åt vänster
	Töm	Numerisk redigering • Raderar visningen
	Decimalpunkt	Numerisk redigering • För in en decimalpunkt
	Plus/minus-tecken	Numerisk redigering • Byter tecknet på det införda värdet
  till	Numerisk	Numerisk redigering • För in motsvarande tecken

Snabbstartsvägledning via den handhållna programmeringsenheten

Anmärkning: Varje gång som Snabbstartsvägledningen initieras, är startinställningarna fabriksstandardvärdet. Vägledningen kommer inte ihåg föregående användardefinierade inställningar.

1. Snabbstart

- Rikta programmeringsenheten mot displayen (från ett maximalt avstånd på 300 mm [1 fot.], och tryck sedan på **HÖGER-pil**  för att aktivera **PROGRAM-läge** och öppna menynivå 1.
- Tryck in **HÖGER-pil**  två gånger för att navigera till menyposition 1.1 och öppna parameterruta.

- c) Tryck in **HÖGER-pil** ➡ för att öppna **Redigeringsläge** eller **NER-pil** ▼ för att acceptera standardvärden och gå direkt till nästa position.
- d) För att ändra en inställning, rulla till den önskade positionen eller knappa in ett nytt värde.
- e) Efter ändring av ett värde, tryck in **HÖGER-pil** ➡ för att acceptera det och tryck in **NER-pil** ▼ för att gå till nästa position.
- f) Snabbstartsställningar blir aktiva först efter att du valt **Yes (Ja)** på **Apply changes (Tillämpa ändringar)** i steg 1.7.

1.1. Material

Tillval	LIQUID (VÄTSKA)
	LIQUID LOW DK (låg dielektrikumvätska)

1.2. Svarshastighet

Ställer in enhetens reaktionshastighet på mätvärdesändringar i målområdet.

Tillval	SLOW (LÅNGSAM)	0,1 m/minut
	MED (MEDEL)	1,0 m/minut
	FAST (SNABB)	10,0 m/minut

Använd en inställning just över den maximala fyllnings- eller tömningshastigheten (den som är störst av dem).

1.3. Sensorenheter

Välj enheterna för Snabbstartsvariablerna (övre och undre kalibreringspunkt, och nivå, avstånd, eller rymd).

Alternativ	M, CM, MM, FT, IN
-------------------	-------------------

1.4. Drift

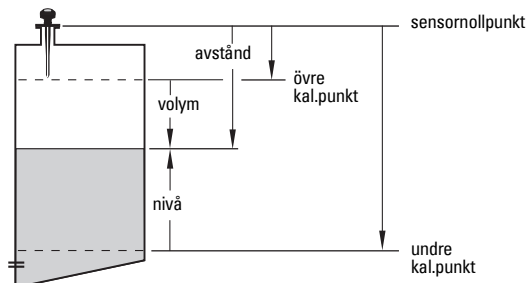

Drifttyper	NO SERVICE (INGEN DRIFT)	SITRANS LR200 stoppar uppdateringsmätningar och tillhörande kretsström. Senaste giltiga mätning visas.
	LEVEL (NIVÅ)	Avstånd till materialytan räknat från Undre kalibreringspunkt (process tom nivå).
	SPACE (VOLYM)	Avstånd till materialytan räknat från Övre kalibreringspunkt (process full nivå).
	DISTANCE (AVSTÅND)	Avstånd till materialyta räknat från Sensorns nollpunkt.

1.5. Undre kalibreringspunkt

Avstånd från Sensornollpunkt till Undre kalibreringspunkt: vanligen process tom nivå.

Värden	Område: 0,0000 till 20,000 m
---------------	------------------------------

1.6. Övre kalibreringspunkt

Avstånd från Sensornollpunkt till Övre kalibreringspunkt: vanligen process full nivå.

Värden	Område: 0,0000 till 20,000 m
---------------	------------------------------

1.7. Tillämpa? (Tillämpa ändringar)





För att spara Snabbstartinställningarna måste man välja **Yes (Ja)** på tillämpa ändringar.

Tillval	YES (JA), NO (NEJ)
----------------	--------------------

Displayen visar **DONE (GJORT)** när Snabbstarten är framgångsrikt genomförd.

Tryck på **Läge**  för att återgå till Mätläge. SITRANS LR200 är nu klar för användning.

Begäran av en Ekoprofil

- 1) I PROGRAM-läge, navigera till: **Level Meter (Nivåmätare)** > **Diagnostics (Diagnostik)** **(3)** > **Echo Profile (Ekoprofil)** (3.1).
- 2) Tryck in **HÖGER-pil**  för att begära en profil.
- 3) Tryck i profilskrmen, in **UPP-pil**  för att välja **Överför** ikon, och **HÖGER-pil**  för att uppdatera profilen.
- 4) Tryck in **NER-pil**  för att välja **Utgång** ikon, sedan **HÖGER-pil**  för att återgå till föregående meny.

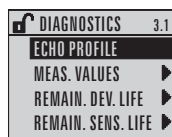

överför ikon, bortvald

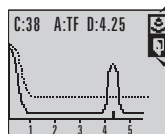

utgång ikon, vald

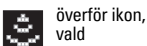

överför ikon, vald



utgång ikon, bortvald

SITRANS LR200 Kommunikationer: HART

- Du behöver den kompletta manualen för att få en lista på tillämpliga parametrar.
- Vi rekommenderar att du använder processinstrumenthanteraren SIMATIC "Process Device Manager" (PDM) för att programmera instrumentet.

SIMATIC PDM

Anmärkningar:

- Vi rekommenderar användning av SIMATIC PDM Rev. 6.0 SP3 eller högre.
- SIMATIC PDM Rev. 5.2 SP1 understöds endast för baskonfiguration och felavhjälpling. För avancerade funktioner såsom Snabbstartsvägledning, krävs Revision 6.0 SP3 eller högre.

SIMATIC PDM är ett programvarupaket som används för att köra igång och upprätthålla funktionen hos SITRANS LR200 och andra processinstrument. Var god läs användarmanualen eller online-hjälp för detaljer i användandet av SIMATIC PDM. (Mer information ges på www.siemens.com/simatic-pdm). Gå till **Products and Solutions (Produkter och Lösningar)** > **Products and Systems (Produkter och System)** > **Communications and Software (Kommunikationer och Programvara)** > **Process Device Manager (Processinstrumenthanterare)**.

Electronic Device Description (EDD) (Beskrivning Elektroniska Instrument)

- Du hittar EDD i Instrumentkatalogen Device Catalog, under **Sensors/Level/Echo/Siemens Milltronics/SITRANS LR200**.
- Kontrollera produktsidan på vår hemsida på: www.siemens.com/LR200, under **Downloads (Nedladdningar)**, för att säkerställa att du har den senaste versionen av SIMATIC PDM, senaste Service Pack (SP) och senaste hot fix (HF). Om du behöver installera en ny EDD se *Konfigurering av ett nytt instrument* nedan.

Konfigurering av ett nytt instrument

Anmärkning: Klickning på **Cancel (Upphäv)** under en uppladdning från instrumentet till SIMATIC PDM resulterar i att vissa parametrar uppdateras.

1. Kontrollera att du har den senaste EDD:n, och ladda vid behov ner den från den ovan listade produktsidan. Spara filerna på din dator, och extrahera den zippade filen till en lättåtkomlig plats. Lansera **SIMATIC PDM – Manager Device Catalog (Manager Instrumentkatalog)**, bläddra till den uppackade EDD-filen och välj den.
2. Starta SIMATIC PDM och skapa ett nytt projekt för LR200. Applikationsvägledningar för installation av HART-apparater med SIMATIC PDM kan laddas ner från produktsidan på vår hemsida på: www.siemens.com/LR200.
3. Ladda in parametrar på PC/PG.
4. Kalibrera instrumentet med hjälp av Snabbstartsvägledningen (se nedan).

Snabbstartsvägledning via SIMATIC PDM

Anmärkningar:

- Snabbstartsvägledningens inställningar är beroende av varandra och ändringar gäller först efter att du klickat på **Transfer (Överför)** i slutet av steg 5.
- Varje gång som Snabbstartsvägledningen initieras, är startinställningarna fabriksstandardvärden. Vägleddningen kommer inte ihåg föregående användardefinierade inställningar.
- Klicka på **BACK (BAKÅT)** för att gå tillbaka och göra om en inställning eller **Cancel (Upphäv)** för att gå ur Snabbstarten.

Starta SIMATIC PDM, öppna menyn **Device – Quick Start (Instrument - Snabbstart)**, och följ stegen 1 till 5.

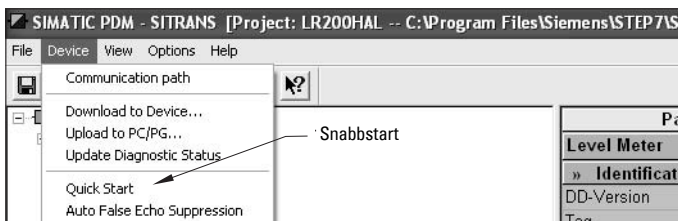

Underhåll

SITRANS LR200 kräver vare sig underhåll eller rengöring under normala driftförhållanden. Om rengöring blir nödvändig under svåra driftförhållanden:

1. Notera antenmaterial och processmedium och välj en rengöringslösning som inte är skadlig för någondera.
2. Ta ur instrumentet och rengör antennen med en duk och lämplig rengöringslösning.

Reparation och ansvarsbegränsning

För detaljerad information, v.g. se omslagets tredje sida.

Tabell över maximala processtemperaturer

! VARNING: Inre temperatur får inte överstiga 80 °C (176 °F)

Maximala Fläns- och Processtemperaturer mot tillåten omgivande temperatur för flänsadapterversioner av SITRANS LR200

- Tabellen nedan är endast en vägledning.
- Den återger inte varje möjlig typ av processanslutning. Den kommer t.ex. INTE att gälla om ni monterar SITRANS LR200 direkt på en plåttanksyta.
- Den beaktar inte uppvärmning från direkt solljusexponering
- Ni kan använda parameter 3.14.1 för att övervaka den aktuella innertemperaturen.

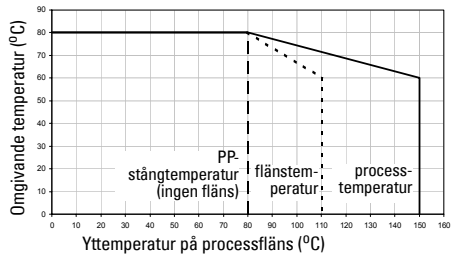

Kretseffekt

Typisk anslutning ritning

Anmärkning: Kretsspänning är spänningen vid uttagen på strömförsörjningen (inte spänningen vid instrumentets uttag).

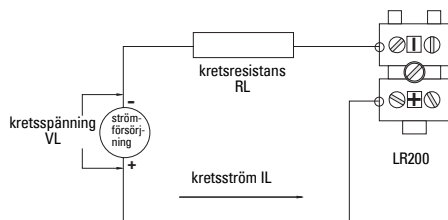

Tillåten driftyta

Kurva 1 (Allmänt syfte, Egensäker, Icke antändlig)

Kretsspänning mot Kretsresistans

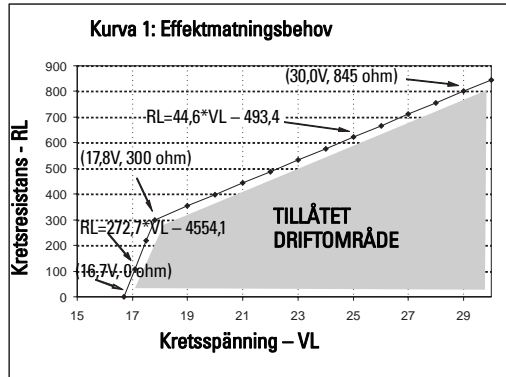

Kurva 2 (Flamsäker, Förhöjd säkerhet, Explosionssäker)

Kretsspänning mot Kretsresistans

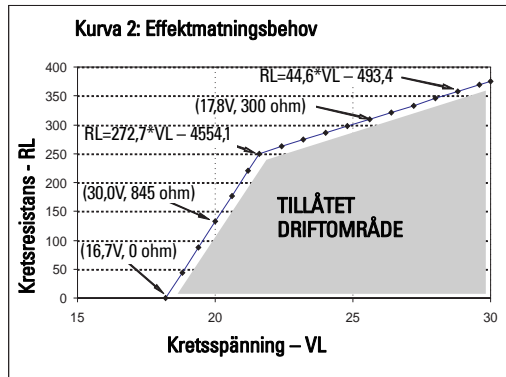

Startkurva

Anmärkning: Vid start kan det ta från 25 till 55 sekunder för instrumentet att rapportera aktuell materiell nivå.

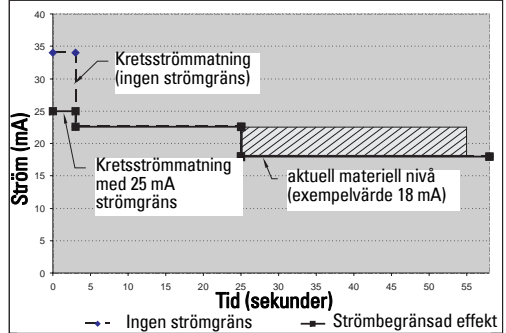

Anmärkningar

Appendix A: ATEX Certificates

Note: ATEX certificates can be downloaded from the product page of our website at: www.siemens.com/LR200.

Flameproof/Increased Safety: ATEX Certificate



sira
CERTIFICATION

1 EC TYPE-EXAMINATION CERTIFICATE

2 Equipment intended for use in Potentially Explosive Atmospheres Directive 94/9/EC

3 Certificate Number: **Sira 05ATEX1001X** Issue: **3**

4 Equipment: **Sitrans LR200 HART**

5 Applicant: **Siemens Milltronics Process Instruments Inc.**

6 Address: 1954 Technology Drive
Peterborough
Ontario
K9J 7B1
Canada

7 This equipment and any acceptable variation thereto is specified in the schedule to this certificate and the documents therein referred to.

8 Sira Certification Service, notified body number 0518 in accordance with Article 9 of Directive 94/9/EC of 23 March 1994, certifies that this equipment has been found to comply with the Essential Health and Safety Requirements relating to the design and construction of equipment intended for use in potentially explosive atmospheres given in Annex II to the Directive.

The examination and test results are recorded in the confidential reports listed in Section 14.2.

9 Compliance with the Essential Health and Safety Requirements, with the exception of those listed in the schedule to this certificate, has been assured by compliance with the following documents:

EN 50014:1997 (amendments A1 to A2)	EN50019:2000	EN 50028:1987
EN50018:2000	EN 50020:2002	EN 50284:1999

10 If the sign 'X' is placed after the certificate number, it indicates that the equipment is subject to special conditions for safe use specified in the schedule to this certificate.

11 This EC type-examination certificate relates only to the design and construction of the specified equipment. If applicable, further requirements of this Directive apply to the manufacture and supply of this equipment.

12 The marking of the equipment shall include the following:

II 1/2G
EEx dmia IIC T4
EEx emia IIC T4
(Ta = -40°C to 80°C)

Project Number 52A15921
C. Index 13

C Ellaby
Certification Officer

This certificate and its schedules may only be reproduced in its entirety and without change.

Form 9400 Issue 1

Page 1 of 4

Sira Certification Service

Rake Lane, Eccleston, Chester, CH4 9JN, England

Tel: +44 (0) 1244 670900
Fax: +44 (0) 1244 981330
Email: info@siracertification.com
Web: www.siracertification.com

Flameproof/Increased Safety: ATEX Certificate (continued)



SCHEDULE

EC TYPE-EXAMINATION CERTIFICATE

Sira 05ATEX1001X
Issue 3

13 DESCRIPTION OF EQUIPMENT

The Sitrans LR 200 provides 2-wire, 4-20 mA level measurement using microwave radar technology. This version incorporates an on-board, intrinsically safe (IS) barrier, which is protected by encapsulation (EEx m). The IS Barrier then feeds the remaining electronics, these are also encapsulated but protected by intrinsic safety (EEx ia). Externally, the equipment consists of two sections, the aluminium enclosure and the radar antenna. The aluminium enclosure is category 2 and the radar antenna is category 1. The aluminium enclosure is further sub-divided into two parts, the terminal compartment and the electronics housing. The field connections are made inside the terminal compartment, which is protected by either increased safety (EEx e) or flameproof (EEx d), the electronics housing is protected by both encapsulation (EEx m) and intrinsic safety (EEx ia). The increased safety (EEx e) or flameproof (EEx d) versions are separate pieces of equipment, so both types of protection are not marked on the same equipment item. The terminal compartment, accessible via the threaded enclosure cover, allows electrical connection via two cable/conduit entries to a terminal block. Electrical connection to the remainder of the equipment is then made via a custom cemented bushing situated at the base of the terminal housing. The electronics housing contains four PCBs, the common module, the LCD module, the radar interface module and the radar technology module. All of the circuitry, except for the LCD module, is encapsulated using a hard-setting epoxy. The common module contains the IS barrier, which is protected by encapsulation (EEx m). It also contains the power supply and microprocessor circuitry, but this is protected by intrinsic safety (EEx ia).

The equipment has the following rating: Um = 250 V
Input = 24 Vdc Nominal, 30 Vdc Max, 4 – 20 mA

Variation 1

This variation introduced the following change:

- i. The Radar Interface Module covered by modification 1 of variation 8 to Sira 03ATEX2142X was permitted to be used in all previous versions of the Sitrans LR200.

Variation 2

This variation introduced the following change:

- i. The Radar Technology Module covered by Sira 03ATEX2142X Variation 10, was permitted to be used in all previously certified versions of the Sitrans LR200.

Variation 3

This variation introduced the following changes:

- i. The Sitrans EMC filter PCB was added, drawing No. PBD-24751628. This PCB is also used in the Sitrans LR250 HART.
- ii. The new LR200 Series Display Module was added, drawing No. PBD-24751638.
- iii. The blocking capacitors C72, C78, C69 and C77 (IS components, page 5) of the radar technology module were changed from 220pF to 100pF each, drawing No. PBD-24751623.
- iv. Suppression diodes D2 to D7 (IS components, page 2) of radar interface module were changed from BYD77D type to 507J type, drawing No. PBD-24751608.

This certificate and its schedules may only be reproduced in its entirety and without change.

Form 9400 Issue1

Page 2 of 4

Sira Certification Service

Rake Lane, Eccleston, Chester, CH4 9JN, England

Tel: +44 (0) 1244 670900
 Fax: +44 (0) 1244 681330
 Email: info@siracertification.com
 Web: www.siracertification.com



SCHEDULE

EC TYPE-EXAMINATION CERTIFICATE

Sira 05ATEX1001X
Issue 3

- v. The Common Module, drawing No. PBD-24751620, was modified as follows:
- The drawing title was changed to LR200 Series EEx de Common Module
 - Z1 was changed (Non IS, page 2) from 15 V to 20 V
 - Populated R105 (Non IS, page 4)
 - Added "Do not populate" note for R106 (Non IS, page 4)
 - Added "Do not populate when using LUI display PBD-24751638" note for the display negative supply PLCD circuit consisting of U9, U11, R89, R74, R65, R70, C63, C48, C50 (Non IS, Page 5), D13, D14, R7, R8 (IS components, page 12)
 - Microprocessor U4 (Non IS, page 9) was changed with newest model
 - R61 (IS component, page 12) was changed from 5.1 K 0.5 W to 4.99 K 0.5 W, same 2010 package
 - R67 (IS component, page 12) was changed from 5.1 K, 0.5 W, 2010 package to 2.21 K, 1 W 2010 M series package

14 DESCRIPTIVE DOCUMENTS

14.1 Drawings

Refer to Certificate Annexe.

14.2 Associated Sira Reports and Certificate History

Issue	Date	Report number	Comment
0	17 August 2005	R52A12835A	The release of prime certificate.
1	6 December 2005	R52A13955A	The introduction of Variation 1.
2	25 April 2006	R52A14671B	The introduction of Variation 2.
3	19 April 2007		This Issue covers the following changes: <ul style="list-style-type: none"> • All previously issued certification was rationalised into a single certificate Issue 3, Issues 0 to 2 referenced above are only intended to reflect the history of the previous certification and have not been issued as documents in this format. • The clarification of the marking in section 12. The introduction of Variation 3.
		R52A15921A	

15 SPECIAL CONDITIONS FOR SAFE USE (denoted by X after the certificate number)

- 15.1 Parts of the enclosure may be non-conducting and may generate an ignition-capable level of electrostatic charge under certain extreme conditions. The user should ensure that the equipment is not installed in a location where it may be subjected to external conditions (such as high-pressure steam) which might cause a build-up of electrostatic charge on non-conducting surfaces.
- 15.2 As either Aluminium, Magnesium, Titanium or Zirconium may be used at the accessible surface of the equipment. In the event of rare incidents, ignition sources due to impact and friction sparks could occur. This shall be considered when the Sitrans LR200 or Sitrans Probe LR is being installed in locations that specifically require group II, category 1G equipment.
- 15.3 The equipment shall be bonded to the system earth in accordance with the relevant code of practice.

This certificate and its schedules may only be reproduced in its entirety and without change.

Form 9400 Issue1

Page 3 of 4

Sira Certification Service

Rake Lane, Eccleston, Chester, CH4 9JN, England

Tel: +44 (0) 1244 670900
 Fax: +44 (0) 1244 681330
 Email: info@siracertification.com
 Web: www.siracertification.com

Flameproof/Increased Safety: ATEX Certificate (continued)



SCHEDULE

EC TYPE-EXAMINATION CERTIFICATE

Sira 05ATEX1001X
Issue 3

16 **ESSENTIAL HEALTH AND SAFETY REQUIREMENTS OF ANNEX II (EHSRs)**

The relevant EHSRs that are not addressed by the standards listed in this certificate have been identified and individually assessed in the reports listed in Section 14.2.

17 **CONDITIONS OF CERTIFICATION**

- 17.1 The use of this certificate is subject to the Regulations Applicable to Holders of Sira Certificates.
- 17.2 Holders of EC type-examination certificates are required to comply with the production control requirements defined in Article 8 of directive 94/9/EC.
- 17.3 The manufacturer shall undertake routine tests in accordance with clauses 7.1 and 7.3 of EN50028: 1987, with the option that that the insulation test may be undertaken at 500 V rms for at least 1 second.
- 17.4 Sitrans LR200 HART covered by this certificate incorporate previously certified devices, it is therefore the responsibility of the manufacturer to continually monitor the status of the certification associated with these devices, and the manufacturer shall inform Sira of any modifications of the devices that may impinge upon the explosion safety design of the Junction Boxes.

This certificate and its schedules may only be reproduced in its entirety and without change.

Form 9400 Issue1

Page 4 of 4

Sira Certification Service

Rake Lane, Eccleston, Chester, CH4 9JN, England

Tel: +44 (0) 1244 670900
 Fax: +44 (0) 1244 681330
 Email: info@siracertification.com
 Web: www.siracertification.com



1 **EC TYPE-EXAMINATION CERTIFICATE**

2 Equipment intended for use in Potentially Explosive Atmospheres Directive 94/9/EC

3 Certificate Number: **Sira 06ATEX2378X** Issue: **0**

4 Equipment: **Sitrans LR200 HART**

5 Applicant: **Siemens Milltronics Process Instruments Inc.**

6 Address: 1954 Technology Drive
Peterborough
Ontario
K9J 7B1
Canada

7 This equipment and any acceptable variation thereto is specified in the schedule to this certificate and the documents therein referred to.

8 Sira Certification Service, notified body number 0518 in accordance with Article 9 of Directive 94/9/EC of 23 March 1994, certifies that this equipment has been found to comply with the Essential Health and Safety Requirements relating to the design and construction of equipment intended for use in potentially explosive atmospheres given in Annex II to the Directive.

The examination and test results are recorded in the confidential reports listed in Section 14.2.

9 Compliance with the Essential Health and Safety Requirements, with the exception of those listed in the schedule to this certificate, has been assured by compliance with the following documents:

EN 50014:1997 (amendments A1 to A2) EN 50020:2002 EN 50284:1999

10 If the sign 'X' is placed after the certificate number, it indicates that the equipment is subject to special conditions for safe use specified in the schedule to this certificate.

11 This EC type-examination certificate relates only to the design and construction of the specified equipment. If applicable, further requirements of this Directive apply to the manufacture and supply of this equipment.

12 The marking of the equipment shall include the following:



II 1G
EEx ia IIC T4 -40°C to +80°C

Project Number 52A15920
C. Index 15

This certificate and its schedules may only be reproduced in its entirety and without change.

C Ellaby
Certification Officer

Form 9400 Issue 1

Page 1 of 2

Sira Certification Service

Rake Lane, Ecclestone, Chester, CH4 9JN, England

Tel: +44 (0) 1244 670900
Fax: +44 (0) 1244 681330
Email: info@siracertification.com
Web: www.siracertification.com

Intrinsically Safe: ATEX Certificate (continued)



sira
CERTIFICATION

SCHEDULE

EC TYPE-EXAMINATION CERTIFICATE

Sira 06ATEX2378X
Issue 0

13 DESCRIPTION OF EQUIPMENT

Sitrans LR200 is a Continuous Level measurement instrument. The unit is connected to loop power (4-20 mA), which provides power and communication to and from the device. It comprises either a plastic or aluminium enclosure with a display window. The enclosure contains five PCBs; Common Module, RADAR Interface Board, RADAR Technology Module, Display Module and EMC filter PCB. All of the circuitry, except for the Display Module, EMC filter PCB and the RADAR antenna is encapsulated. The equipment antenna is attached to the base of the enclosure and can be either a one-piece polycarbonate rod or a metal adapter for use with external antennae. The unit can be programmed using an Intrinsically Safe IR programmer pointed through the display window. The equipment has the following safety parameters:

U_i = 30V
I_i = 120mA
P_i = 0.8W
C_i = 15nF
L_i = 0.1mH

14 DESCRIPTIVE DOCUMENTS

14.1 Drawings

Refer to Certificate Annex.

14.2 Associated Sira Reports and Certificate History

Issue	Date	Report number	Comment
0	25 June 2007	R52A15920A	The release of prime certificate.

15 SPECIAL CONDITIONS FOR SAFE USE (denoted by X after the certificate number)

- 15.1 Parts of the enclosure may be non-conducting and may generate an ignition-capable level of electrostatic charge under certain extreme conditions. The user should ensure that the equipment is not installed in a location where it may be subjected to external influences, which might cause a build-up of electrostatic charge on non-conducting surfaces.
- 15.2 As either Aluminium, Magnesium, Titanium or Zirconium may be used at the accessible surface of the equipment. In the event of rare incidents, ignition sources due to impact and friction sparks could occur. This shall be considered when the Sitrans LR200 is being installed in locations that specifically require group II, category 1G equipment.
- 16 **ESSENTIAL HEALTH AND SAFETY REQUIREMENTS OF ANNEX II (EHSRs)**
The relevant EHSRs that are not addressed by the standards listed in this certificate have been identified and individually assessed in the reports listed in Section 14.2.
- 17 **CONDITIONS OF CERTIFICATION**
- 17.1 The use of this certificate is subject to the Regulations Applicable to Holders of Sira Certificates.
- 17.2 Holders of EC type-examination certificates are required to comply with the production control requirements defined in Article 8 of directive 94/9/EC.

This certificate and its schedules may only be reproduced in its entirety and without change.

Form 9400 Issue1

Page 2 of 2

Sira Certification Service

Rake Lane, Eccleston, Chester, CH4 9JN, England

Tel: +44 (0) 1244 670900
Fax: +44 (0) 1244 681330
Email: info@siracertification.com
Web: www.siracertification.com



www.siemens.com/processautomation

Siemens Milltronics Process Instruments Inc.
1954 Technology Drive, P.O. Box 4225
Peterborough, ON, Canada K9J 7B1
Tel: (705) 745-2431 Fax: (705) 741-0466
Email: techpubs.smpi@siemens.com

© Siemens Milltronics Process Instruments Inc. 2008
Subject to change without prior notice



Printed in Canada

Rev. 1.1