

**Thermo Scientific AquaSensors™
RDO® Pro Optical Dissolved
Oxygen Measurement System
User Guide**



ROSS and the COIL trade dress are trademarks of Thermo Fisher Scientific Inc. U.S. patent 6,793,787.

AQUAfast, Cahn, ionplus, KNIpHE, No Cal, ORION, perpHect, PerpHecT, PerpHecTion, pHISA, pHuture, Pure Water, Sage, Sensing the Future, SensorLink, ROSS, ROSS Ultra, Sure-Flow, Titrator PLUS and TURBO2 are registered trademarks of Thermo Fisher.

1-888-pHAX-ION, A+, All in One, Aplus, AQUAsnap, AssuredAccuracy, AUTO-BAR, AUTO-CAL, AUTO DISPENSER, Auto-ID, AUTO-LOG, AUTO-READ, AUTO-STIR, Auto-Test, BOD AutoEZ, Cable-Free, CERTI-CAL, CISA, DataCOLLECT, DataPLUS, digital LogR, DirectCal, DuraProbe, Environmental Product Authority, Extra Easy/Extra Value, FAST QC, GAP, GLPcal, GLPcheck, GLPdoc, ISEasy, KAP, LabConnect, LogR, Low Maintenance Triode, Minimum Stir Requirement, MSR, NISS, One-Touch, One-Touch Calibration, One-Touch Measurement, Optimum Results, Orion Star, Pentrode, pHuture MMS, pHuture Pentrode, pHuture Quatrode, pHuture Triode, Quatrode, QuiKcheK, rf link, ROSS Resolution, SAOB, SMART AVERAGING, Smart CheK, SMART STABILITY, Stacked, Star Navigator 21, Stat Face, The Enhanced Lab, ThermaSense, Triode, TRIUMpH, Unbreakable pH, Universal Access are trademarks of Thermo Fisher.

© 2009 Thermo Fisher Scientific Inc. All rights reserved. All trademarks are the property of Thermo Fisher Scientific Inc. and its subsidiaries.

The specifications, descriptions, drawings, ordering information and part numbers within this document are subject to change without notice.

This publication supersedes all previous publications on this subject.

Preface

This instruction manual serves to explain the use of the Thermo Scientific AquaSensors RDO Pro Optical Dissolved Oxygen System and is written to cover as many applications as possible. Please do not hesitate to contact Thermo Fisher Scientific or an authorized representative with questions or concerns.

The information presented in this instruction manual is subject to change without notice as improvements are made, and does not represent any commitment whatsoever on the part of Thermo Fisher Scientific.

Thermo Fisher Scientific cannot accept any responsibility for damage or malfunction of the sensor due to improper use.

Contact Information

To contact Thermo Scientific AquaSensors Technical Support:

Within the United States call 1.800.225.1480 or fax 978-232-6015.

Outside the United States call 978.232.6000 or fax 978.232.6031.

In Europe, the Middle East and Africa, contact your local authorized dealer.

Visit us on the web at www.thermo.com/processwater

Safety Information



The RDO Pro Optical Dissolved Oxygen System shall be installed and operated only in the manner specified. Only a skilled, trained or authorized person should carry out installation, setup and operation of the system.

Before using the system, make sure that is connected as specified. Failure to do so may result in permanent damage to the system or its components.

Protection against electric shock will be achieved only by observance of the corresponding installation rules.

TABLE OF CONTENTS

1.	INTRODUCTION.....	6
1.1.	GENERAL INFORMATION.....	6
1.2.	INTENDED USE.....	6
1.3.	SAFETY INSTRUCTIONS.....	7
1.4.	REMOVAL FROM SERVICE / CORRECT DISPOSAL OF THE SYSTEM.....	7
2.	PRODUCT DESCRIPTION.....	8
2.1.	SERIAL NUMBERS.....	9
2.2.	UNPACKING THE SENSOR.....	9
3.	MOUNTING HARDWARE.....	10
3.1.	IMMERSION HARDWARE.....	11
3.2.	WASH HARDWARE.....	12
4.	WIRING.....	13
4.1.	MODBUS MASTER WITH BUILT-IN RS485.....	13
4.2.	MODBUS MASTER WITH BUILT-IN RS232 (CONVERTER REQUIRED).....	14
	<i>Converter.....</i>	<i>14</i>
4.3.	AV38 AS MODBUS MASTER.....	15
5.	CARE AND MAINTENANCE.....	16
5.1.	CLEANING THE SENSOR CAP.....	16
	<i>Cleaning the Optical Window.....</i>	<i>16</i>
5.2.	CLEANING THE SENSOR BODY.....	16
5.3.	CAP STORAGE.....	16
5.4.	REPLACING THE SENSOR CAP.....	16
6.	AV38 LOCAL DISPLAY INTERFACE.....	18
6.1.	MEASURE SCREEN OVERVIEW.....	18
6.2.	MENU STRUCTURE.....	19
6.3.	WATER-SATURATED AIR (SPAN) CALIBRATION.....	22
6.4.	1-POINT SAMPLE (SPAN) CALIBRATION.....	25
6.5.	TEMPERATURE CALIBRATION.....	27
6.6.	CONFIGURATION.....	29
6.7.	ANALOG OUTPUT OVERVIEW.....	30
6.8.	RELAY FUNCTION OVERVIEW.....	31
7.	MODBUS REGISTER MAP.....	32
7.1.	DATA FORMATS.....	33
7.2.	DO SENSOR REGISTERS.....	35
	<i>DO Sensor Floating-Point Value.....</i>	<i>35</i>
	<i>DO Sensor Integer Value.....</i>	<i>35</i>
	<i>DO Sensor Value Scale Factor.....</i>	<i>35</i>
	<i>DO Sensor Units.....</i>	<i>36</i>

<i>DO Sensor Filter</i>	36
<i>DO Salinity Floating-Point Value</i>	36
<i>DO Salinity Integer Value</i>	37
<i>DO Salinity Scale Factor</i>	37
<i>DO Barometric Pressure Floating-Point Value</i>	37
<i>DO Barometric Pressure Integer Value</i>	37
<i>DO Barometric Pressure Scale Factor</i>	38
<i>Dissolved Oxygen Concentration Equations</i>	38
<i>Dissolved Oxygen, % Saturation Equations</i>	39
<i>Calibration Calculations</i>	40
7.3. TEMPERATURE REGISTERS.....	40
<i>Temperature Floating-Point Value</i>	40
<i>Temperature Integer Value</i>	41
<i>Temperature Value Scale Factor</i>	41
<i>Temperature Units</i>	41
<i>Temperature Filter</i>	41
7.4. CALIBRATION REGISTERS	42
<i>Calibration Status</i>	42
<i>Calibration Type</i>	42
<i>Cal Sensor 1-Point Sample Float Value</i>	43
<i>Cal Sensor 1-Point Sample Integer Value</i>	43
<i>Cal Sensor 1-Point Sample Value Scale Factor</i>	43
<i>Cal Temperature 1-Point Sample Float Value</i>	43
<i>Cal Temperature 1-Point Sample Integer Value</i>	44
<i>Cal Temperature 1-Point Sample Value Scale Factor</i>	44
<i>Cal Sensor In Air</i>	44
<i>Cal Abort</i>	44
<i>Entering Calibration Registers</i>	44
7.5. COMMUNICATION REGISTERS	45
<i>Communication Status</i>	45
<i>Modbus Slave Address</i>	45
<i>Modbus Baud Rate</i>	45
<i>Modbus Parity</i>	46
<i>PLC Data Type</i>	46
7.6. STATUS REGISTERS	47
<i>Sensor Memory Status</i>	47
<i>Configuration Memory Status</i>	47
<i>Calibration Memory Status</i>	48
<i>Run Status</i>	48
<i>Main Serial Number</i>	48
<i>DataStick Code Version</i>	48
<i>Node Address</i>	49
<i>Sensor Type</i>	49
<i>Comms Adapter Code Version</i>	49
<i>Cap Expiration Time</i>	49
8. SPECIFICATIONS	50

9. RDO PRO OPTICAL DISSOLVED OXYGEN SYSTEM ORDER MATRIX AND ACCESSORIES	51
9.1. ACCESSORIES	51
10. LIMITED WARRANTY	52
11. TERMS AND CONDITIONS.....	53

1. INTRODUCTION

1.1. General Information

Thank you for purchasing the Thermo Scientific AquaSensors RDO Pro Optical Dissolved Oxygen System. The product is designed for continuous use in industrial process applications and complies with safety regulations currently in force. Improper use could lead to hazards for the user or a third-party, and/or adverse effects to the plant or other equipment.

Thermo Fisher Scientific does not accept any liability for damage that may arise if information in this manual is not followed. Therefore, the operating instructions and specifications must be read and understood by all persons involved in installation and operation of this equipment.

This manual identifies safety instructions and additional information by means of the following symbols:

	This symbol draws attention to safety instructions and warnings of potential danger which, if neglected, could result in injury to persons and/or damage to property.
---	--

	This symbol identifies additional information and instructions which, if neglected, could lead to inefficient operation and possible loss of production.
--	---

It is recommended that this manual be made accessible to everyone who may need it as a reference.

Please contact Thermo Fisher Scientific or an authorized representative with any questions.

1.2. Intended Use

The RDO Pro Optical Dissolved Oxygen System is used for continuous monitoring dissolved oxygen in applications where the range of measurement is between 0 ppm and 20 ppm. The sensor also measures temperature.

Any other use, or use not mentioned here, that is incompatible with the technical specifications is deemed inappropriate. The operator is solely responsible for any damage arising from such use.

Other prerequisites for appropriate use include:

- Observing the instructions, notes and requirements set out in this instruction manual.
- Observing all local safety regulations.
- Observing all warnings and cautions in the documentation regarding all products used in this measurement system, including the sensor, mounting hardware, AV38 electronics and cabling.
- Observing the prescribed environmental and operational conditions.
- Observing chemical compatibility with all wetted materials.

1.3. Safety Instructions

The system should be installed and operated only by personnel familiar with the system and qualified for such work.



A defective system should be returned to Thermo Fisher Scientific for repair or replacement. Contact Thermo Fisher Scientific to obtain a Return Material Authorization (RMA) number.

No modifications to the system are allowed. Thermo Fisher Scientific accepts no responsibility for damage caused by unauthorized modifications. The risk is borne entirely by the user.

1.4. Removal from Service / Correct Disposal of the System

Removal from Service

- Disconnect the cable wiring from the controller terminal block.
- Remove the system from the mounting hardware.

Correct Disposal of System

- When the system is taken out of service, observe the local environmental regulations for correct disposal.

2. PRODUCT DESCRIPTION

Your new RDO Pro Optical Dissolved Oxygen System is a rugged, reliable system designed to deliver accurate dissolved oxygen (DO) data across a wide measuring range while reducing maintenance costs. It features the latest optical technology for DO measurement. The system consists of the following:

- Cable (10 m standard, customizable to other lengths) with stripped and tinned ends
- Black sensor body with removable nose cone
- Optical DO sensing cap
- Silver thermistor

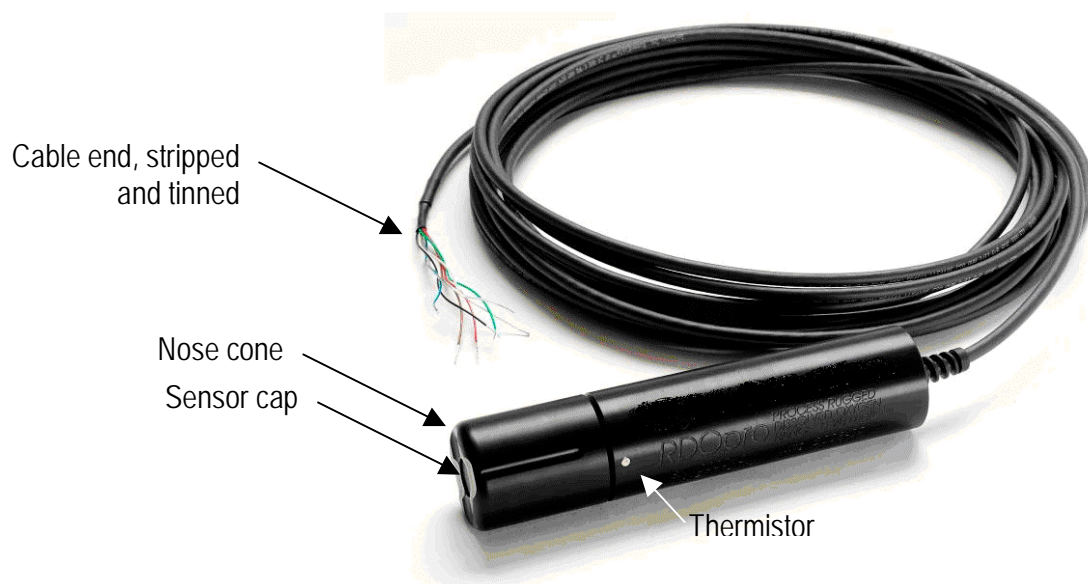

The System is used for continuous monitoring of dissolved oxygen from 0 ppm to 20 ppm. The system also measures temperature from 0°C to 100°C. The optical sensor head is pre-calibrated and the zero is factory set. The sensor retains calibration values and does not require a new calibration when the system is connected to a new AV38 Display Unit, PC, or PLC.

The communications supports measurement, calibration, configuration and diagnostics functions which can be accessed locally or remotely without an analyzer or controller electronics box.

Product Highlights:

- 0 to 20 ppm Measurement Range
- Calibration stored in Sensor (Does not require recalibration after connection to Analyzer/Controller)
- Immersion and Float Mounting Options
- 0.01 ppm Resolution
- Fast Response
- Provides measurement, calibration, configuration and diagnostic functions without Analyzer/Controller
- Works with AV38 for local display, current output data reporting, and relay control with sensor wash.
- Temperature measurement included

2.1. Serial Numbers

The system's serial number is engraved on the side of the unit. The cap serial number is programmed into the cap's memory chip.

2.2. Unpacking the Sensor

1. Remove the sensor from the box and other packaging materials.
2. Unscrew the nose cone from the sensor and remove the red protective dust cap from the sensor. Save the dust cap for later use.



3. Remove the RDO sensor cap from its shipping/storage sleeve.



4. Align the arrow on the cap with the index mark on the sensor and firmly press the cap onto the sensor, without twisting, until it seals over the probe body.



- ✓ *Avoid allowing moisture, including atmospheric humidity, inside the cap. Keep the cap in its sealed packaging until you are ready to install it. Install promptly. Make sure that o-ring grooves are dry and the o-ring is not rolled or pinched inside the cap.*
- ✓ *The cap's lifetime is 1 year after the first reading has been taken. Install by the date printed on the packaging.*

5. Reattach the nose cone.



3. Mounting Hardware

The cable end of the sensor is internally threaded (1¼ – 1½ NPT) and can be attached to a male threaded pipe. When deployed, make sure that the nose cone and thermistor are completely submerged. The sensor is 9 inches long and 1.75 inches in diameter.

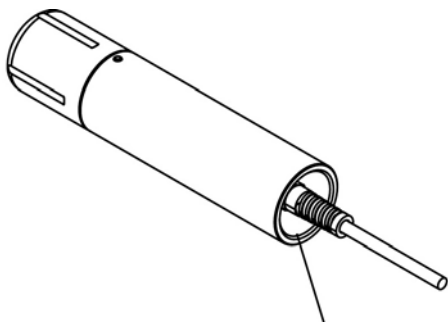

1¼-1½ NPT

For immersion mounting, Thermo Scientific AquaSensors immersion mount hardware with hand rail mounting and ball float is available.

3.1. Immersion Hardware

For immersion mounting applications the sensor is threaded on to the end of a pipe and wired into a junction box at the other end. An extension cable is then wired from the junction box to the controller. The standard pipe length is 7 feet and the assembly is often mounted onto a hand rail assembly for easy repositioning of the sensor in a pond or tank.

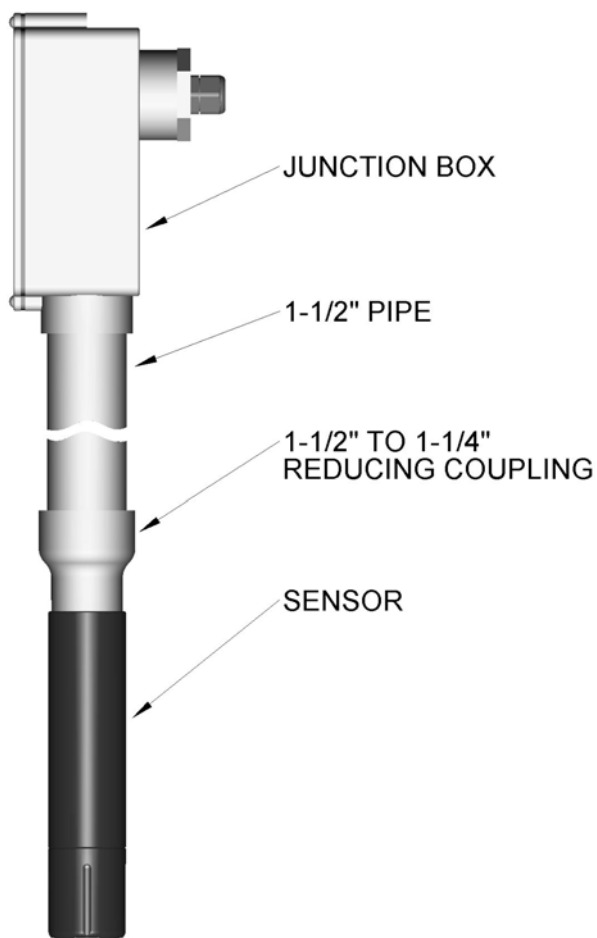

This immersion assembly can be ordered by itself, with a hand rail mounting assembly or with a ball float that keeps the sensor a fixed distance below the surface of the water. Part numbers for the mounting assemblies are shown in the following table.

Mounting Hardware	Description	Part Number
Immersion Assembly	7 ft PVC extension with junction box – RDO Sensors	MH3083-RD
Immersion Assembly w/Swivel Rail Mounting	7 ft PVC extension with junction box – RDO Sensors With swivel hand rail mount.	MH1242-RD
Immersion Assembly w/Swivel and Ball Float	7 ft PVC extension with junction box – RDO Sensors With swivel hand rail mount and inflatable float.	MH1252-RD
Ball Float Platform	Float Platform for up to 4 RDO Pro Sensors or DataSticks	MHFB02-RD
Wash Hardware	Attach air/water purge block to sensor body. Works with compressor & AV38 wash relay or PLC.	MH1222-RD
Wash Hardware	Attach air purge block to sensor body. Includes air compressor; works with AV38 wash relay or PLC.	MH5222-RD
Junction box Extension Cable	For extension cables. Terminal strip included. DataStick Extension cable	JBOXX01 DSECxx; xx=ft

3.2. Wash Hardware

In applications where the sensor cap is quickly fouled, a wash head assembly can be attached. The head slips over the body of the sensor. A single lock screw is tightened to secure the wash head to the sensor. A hose is connected from the wash head to an air compressor or water source valve that is controlled by an AV38 wash relay that is programmed with a wash interval and duration.

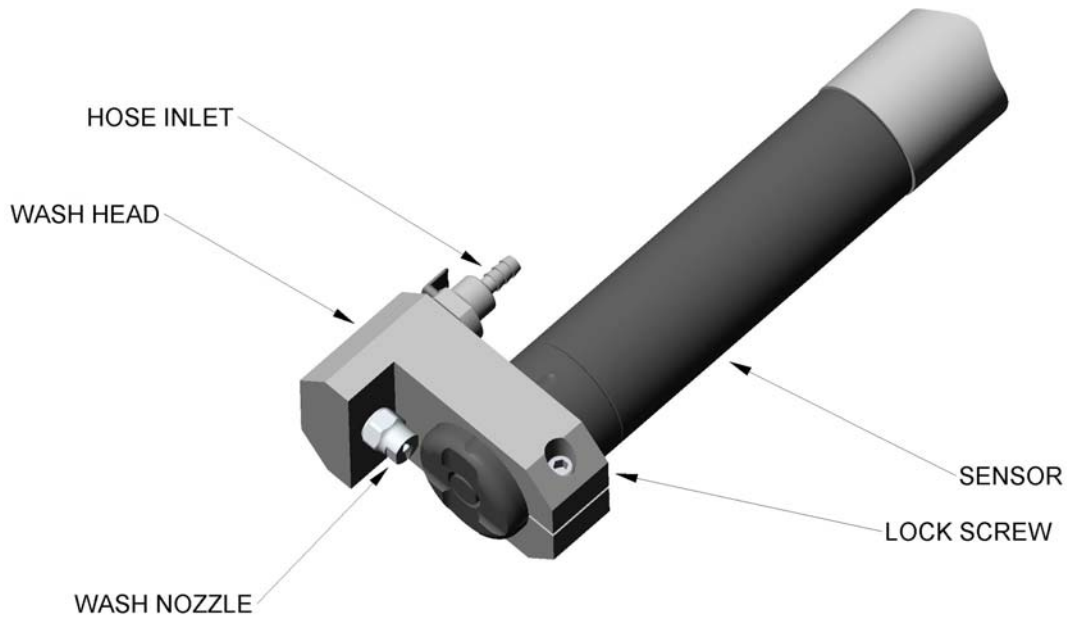

4. Wiring

A printed label affixed near the end of the cable indicates the wiring chart. The standard cable length is 30 feet (~10 meters) with the idea that the cable will terminate in a junction box. It is however possible to order additional cable up to a total maximum of 4000 ft.

The sensor has six wires and a shield. The RED and BLACK wires are for power, the BLUE and GREEN wires are for communications, the BROWN and WHITE wires are unused and a bare shield wire is connected to EARTH GROUND for safety and electromagnetic immunity and emissions. Any Class 2 DC power supply that provides 24 VDC can be used.

RDO Pro Signal Name	RDO Pro Wire Color
External Power (12 to 36 VDC)	Red
Ground/Return	Black
RS485 (-)	Green
RS485 (+)	Blue
Earth	Shield
Unused	Brown
Unused	White

4.1. Modbus Master with Built-in RS485

RDO Pro Signal Name	RDO Pro Wire Color
External Power (12 to 36 VDC)	Red
Ground/Return	Black
RS485 (-)	Green
RS485 (+)	Blue

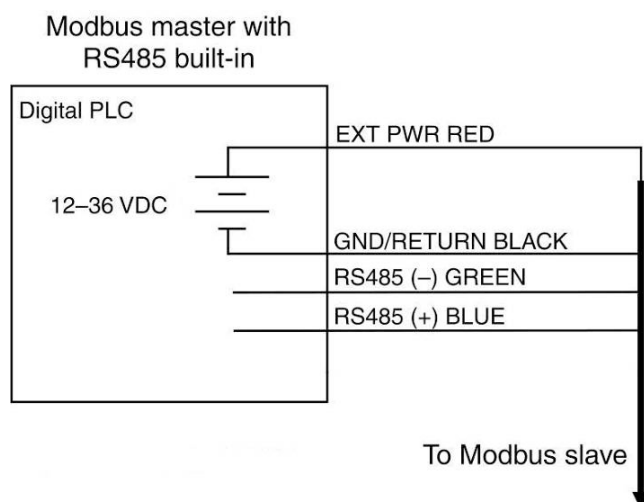

✓ Cable length must not exceed 4000 ft.

4.2. Modbus Master with Built-in RS232 (Converter Required)

RDO Pro Signal Name	RDO Pro Wire Color
External Power (12 VDC, voltage limited by converter)	Red
Ground/Return	Black
RS485 (-)	Green
RS485 (+)	Blue

Modbus master with
RS232 built-in
(converter required)

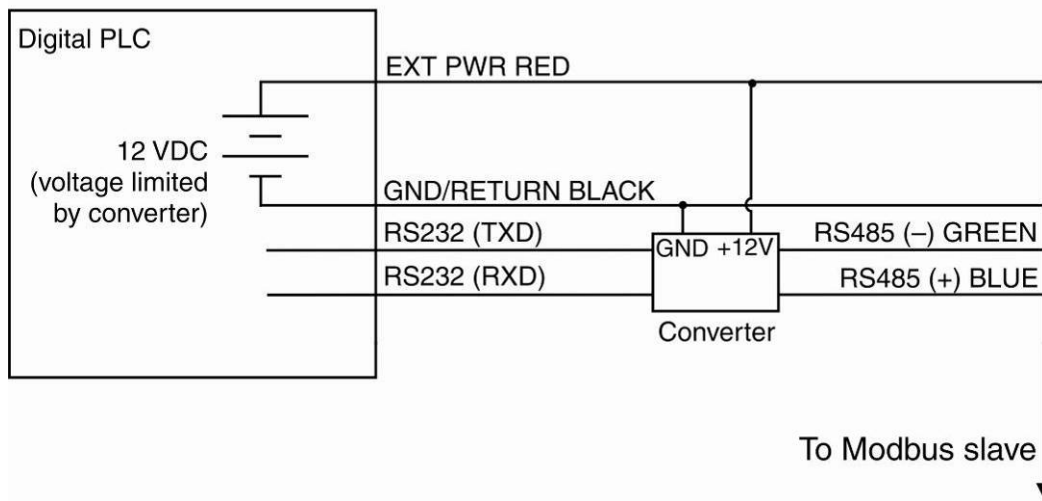

✓ Cable length must not exceed 20 ft.

Converter

Port-powered RS485
converter, such as B&B
Electronics Model 485SD9TB

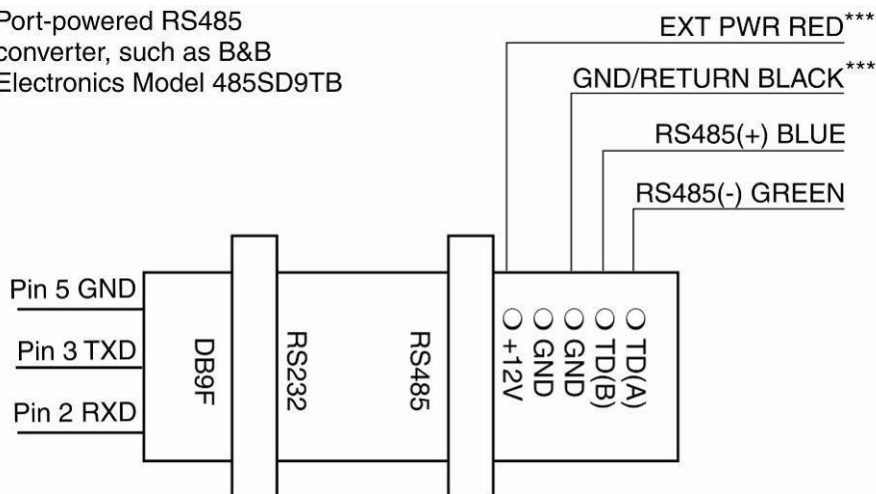

*** Required if port power is not available

4.3. AV38 as Modbus Master

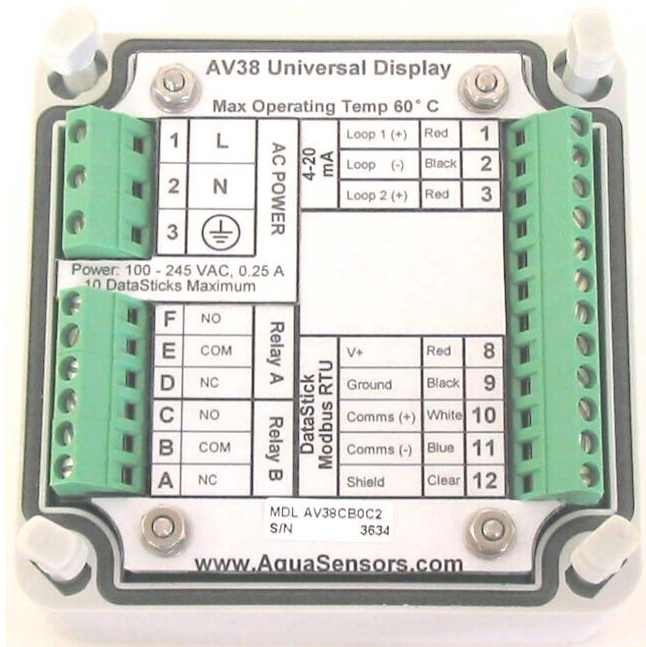

AV38 terminal blocks

RDO Pro Signal Name	RDO Pro Wire Color	AV38 Terminal Number
External Power	Red	8
Ground/Return	Black	9
RS485 (+)	Blue	10
RS485 (-)	Green	11
Earth	Clear	12

Note that the Blue wire from the RDO Pro must be connected to terminal 10 (White) on the AV38 and the Green wire from the RDO Pro must be connected to terminal 11 (Blue) on the AV38 for proper operation.

5. Care and Maintenance

5.1. Cleaning the Sensor Cap

1. Leave the cap and nose cone on the sensor!
2. Rinse the sensor with clean water from a squirt bottle or spray bottle.
3. Gently wipe with a soft-bristled brush or soft cloth if biofouling is present. Use Alconox® to remove grease.
4. If extensive fouling or mineral build-up is present, soak the cap end in vinegar for 15 min., then soak in deionized water for 15 min.



Do not use organic solvents—they will damage the foil.

Do not remove the cap from the sensor prior to brushing.

5. After cleaning the sensor, perform a 1-point user calibration or calibration check.

Cleaning the Optical Window



Perform only when changing the cap. See full instructions in the sensor replacement cap kit.



Do not wet the lens area with water or any solution.

Remove the cap and gently wipe the window with the supplied lens wipe.



Use only the supplied lens wipe for cleaning. Do not use any other wipe or material.

5.2. Cleaning the Sensor Body

With the sensor cap installed on sensor, gently scrub sensor body with a soft-bristled brush or nylon dish scrubber. Use Alconox to remove grease or other matter. Soak in vinegar and deionized (DI) water to remove mineral deposits or extensive fouling as in step 4, above.

5.3. Cap Storage

Prior to installation: Store in factory supplied container.

Installed: Keep or store in the calibration chamber with the storage cap attached (see section 2.1.1) and a few drops of clean water.

5.4. Replacing the Sensor Cap

The sensor cap has a 1-year life after the sensor takes its first reading. Replacement caps are available from Thermo Fisher Scientific or your authorized distributor.

6. Remove the sensor nose cone.
7. Pull the used sensor cap off of the sensor, without twisting.
8. Remove the existing o-rings from the sensor.
9. Use a lint-free cloth to remove any moisture from the sensor body.



Ensure that there is no moisture in the o-ring grooves.

Avoid touching or cleaning the lens with anything other than the supplied lens wipe.

10. Use your finger to apply a layer of lubricant around the o-ring grooves.
11. Place the o-rings on the sensor. Apply another thin layer of lubricant to the o-rings and grooves.



Note: Do not transfer grease to the lens or sensor pins.

12. Clean the lens on the sensor with the wipe provided in the kit and allow to dry thoroughly. Inspect for scratches or dirt.
13. Remove the new cap from its sealed packaging and attach it to the sensor, being careful to press firmly, without twisting, until it seals over the probe body. Make sure that the o-rings are not pinched or rolled between the cap and sensor.
14. Perform a 1-point calibration.

6. AV38 Local Display Interface

For detailed information on configuration of AV38 current outputs, relays, host communications, please refer to the AV38 manual (MAN018AV38). This manual describes basic calibration and configuration functions directly related to DO.

The AV38 is a universal display interface for DataStick sensor systems which includes the RDO Pro Optical Dissolved Oxygen System. The enclosure has ¼ DIN dimensions for easy mounting and is rated NEMA 4X for outdoor use. It uses a liquid crystal display (LCD) with a high contrast backlight for best readability and is powered with 24 volts DC or optionally with line power (90 VAC to 240 VAC 50/60 Hz).



The AV38 automatically recognizes the type of DataStick connected to the system and provides the appropriate calibration, configuration and diagnostic menus. It has options for two 4-20 current loops, two alarm/control/wash relays and network communications to a host computer. In addition, the AV38 can address up to 247 DataStick sensors.

DataStick sensors connected to the AV38 communicate via Modbus RTU. As such, the AV38 can be used to select one of several DataStick sensors on the bus for display, current output reporting and relay alarms by selecting the desired station address. When there is no DataStick sensor connected at the selected network address, the measure screen indicates "DataStick Absent".

There are seven keys for menu navigation. The MENU key is used to toggle between the menu and the measure screen. Pressing the Menu key provides options for calibration, configuration, communications, outputs and relays.

6.1. Measure Screen Overview

The AV38 user interface is shown in Figure 5.1. It consists of an LCD module that contains two lines of 16 alphanumeric characters and seven keys to navigate the menu. The contrast of the LCD module can be adjusted by simultaneously pressing the escape and up-arrow keys (for more contrast) or the escape and down-arrow keys (for less contrast).

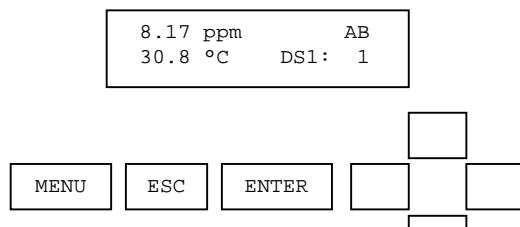

Figure 5.1: The elements of the measure screen

When the RDO Pro Optical Dissolved Oxygen System is not connected to the AV38 display, the measure screen indicates the fault as shown in Figure 5.3.

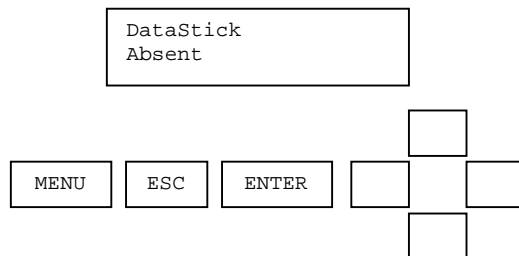

Figure 5.3: The measure screen when the RDO Pro is absent.

Refer to the AV38 Manual (MAN018AV38) for detailed information on User Interface operation.

6.2. Menu Structure

Pressing the menu key while a measure screen is displayed accesses the main menu. Table 5.1 shows all accessible functions including optional features.

Table 5.1: AV38 Main Menu Functions

Main Menu Option	Function
Calibrate (Station Number)	Sensor calibration choices are automatically available for installed sensor head. Enter the MENU from the measure display of interest – station in lower right.
Configure (Station Number)	Configuration choices are automatically available for the installed sensor head. Enter the MENU from the measure display of interest – station in lower right.
DataStick Comms	Set the station address, baud rate and parity for the Modbus DataStick of interest.
Chlorine Configure	Select free or HOCL concentration for output. Select pH compensation – manual set or active measure. (Only when Chlorine DataStick Present).
Hold Outputs	Holds the 4-20 mA and Relay outputs
Analog Output 1	Set 4 mA and 20 mA values. Calibrate and test the current output with a meter.
Analog Output 2 (option)	Set 4 mA and 20 mA values. Calibrate and test the current output with a meter.
PID Controller	Set up PID control functions for analog outputs. Available with pH or Conductivity.
Relay A (option)	Set timer, alarm, or control functions. (Optional)
Relay B (option)	Set timer, alarm, or control functions. (Optional)
Help	Indicates AV38 software version and sensor type
Reset AV38	Resets AV38 configuration to default current output, relay and PID settings.
Exit	Returns to the measure screen

The main menu is navigated using the up/down arrows to display a desired function. The () symbol is used to indicate main menu choices.

To select a menu choice, press the ENTER key when the desired choice is displayed.

To return to the measure screen, press the ESC key.

Whenever there is a value to be entered or a choice to be made, the second line of the display will be surrounded by parentheses (()). The name of the value being entered or choice being made will appear on the upper line of the screen and be appended with a question mark (?) to indicate that the user is to provide input. Figure 4.1 shows the list of standard menu choices and optional menu choices in the context of the AV38 display presentation.

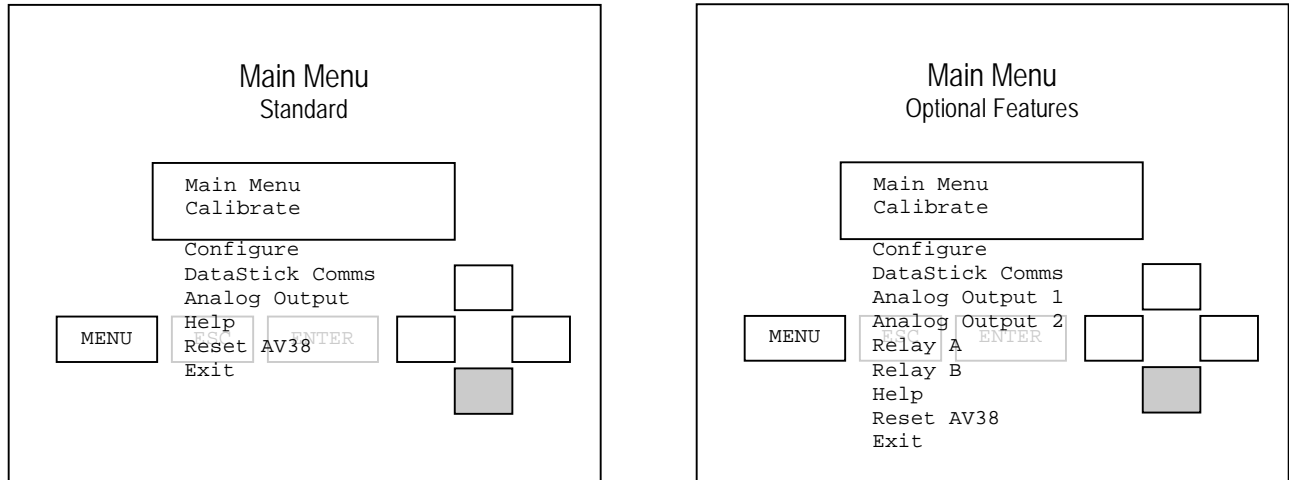

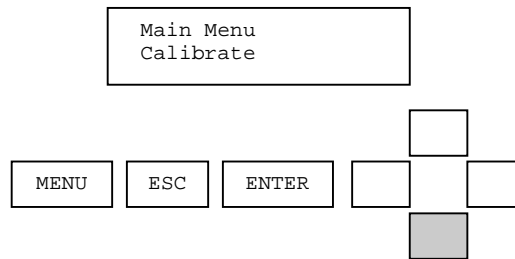

Figure 4.1: The main menu (standard and optional feature lists)

To illustrate navigation through the main menu the following sequence of down arrow key presses is shown. The up arrow can always be used to scroll up through the list.

A pressed key is identified by a gray background, e.g., .

From the measure screen, press MENU to display the list of options. Generally, Calibration will be the first option. To select a calibration function, press ENTER. Press the down arrow to scroll through the list. Press ESC to return to the measure screen.



Pressing the down arrow from Calibration will display Configure. To select Configure functions, press ENTER. To continue scrolling the list, press the down arrow. Press ESC to return to the measure screen.

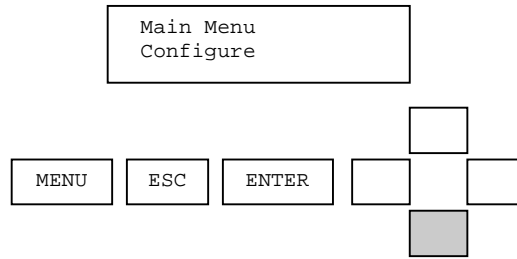

Pressing the down arrow from Configure will display DataStick Comms. To select DataStick Comms functions, press ENTER. To continue scrolling the list, press the down arrow. Press ESC to return to the measure screen.

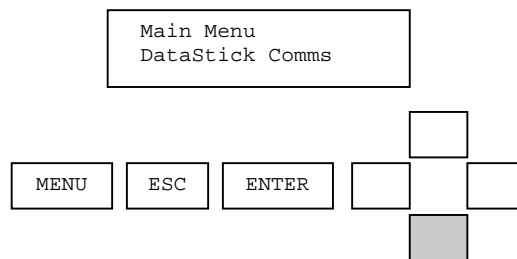

Pressing the down arrow from DataStick Comms will display Analog Output. To select analog output functions, press ENTER. To continue scrolling the list, press the down arrow. Press ESC to return to the measure screen.

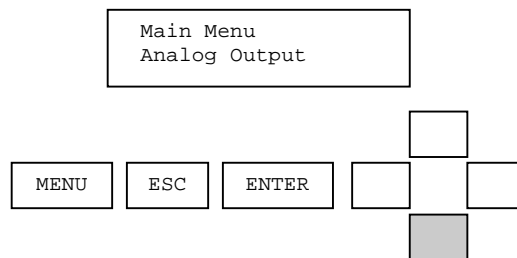

Pressing the down arrow from Analog Output will display Help. To select Help functions, press ENTER. To continue scrolling the list, press the down arrow. Press ESC to return to the measure screen.

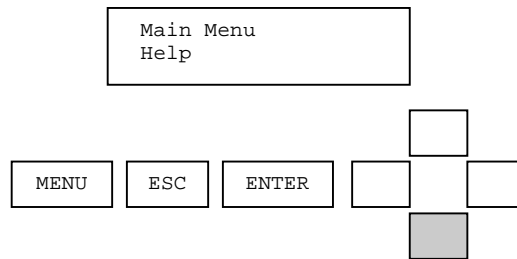

Pressing the down arrow from Help will display Reset AV38. To select Reset functions, press ENTER. To continue scrolling the list, press the down arrow. Press ESC to return to the measure screen.

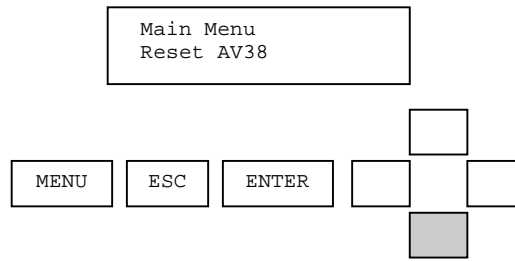

To return to the measure screen press ENTER when in the EXIT screen. Pressing ESC from any screen will take the user up one level. In this example ESC will also take the user to the measure screen. Since this screen is at the bottom of the main menu list, the down arrow will not work here. The up arrow can be used to go back through the list.

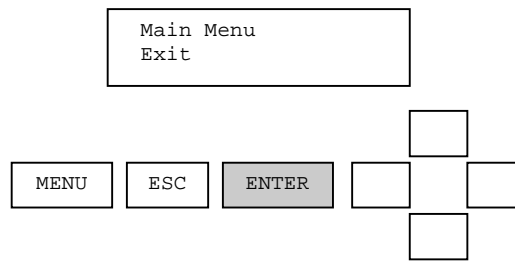

6.3. Water-saturated Air (Span) Calibration

To calibrate the span for the RDO Pro Optical Dissolved Oxygen System in water-saturated air:

1. Remove storage cap from top of calibration chamber and replace with the calibration cap (cap with vent hole).



Calibration cap



Storage cap

- Fill the calibration chamber to the **lower fill line** with approximately 10 mL water.

✓ *Note: The water temperature should be similar to the sample temperature.*



- Gently dry the sensor and foil with a paper towel, making sure there is no water on the body of the sensor and that the sensing foil is free of water and fouling.

- Place the sensor in the calibration chamber so that the sensing foil is about 1 inch above the surface of the water.

✓ *Note: Make sure there are no water droplets on the surface of the foil when in the calibration chamber.*

- Allow five to ten minutes for temperature stabilization prior to calibration. Do not leave the sensor in the calibration chamber for more than 30 minutes. This can allow condensation to form on the surface of the foil, giving false low readings after calibration. If condensation does occur, remove sensor, dry the foil, place in the chamber, and calibrate.

- Perform an air calibration as shown in the following menu tree.

The complete calibrate menu for the RDO Pro is shown below.

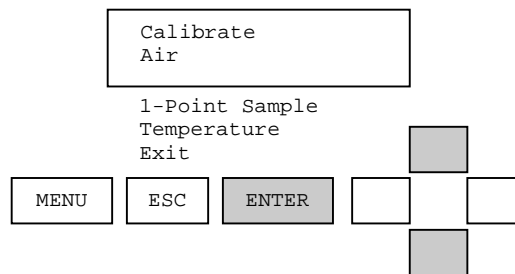

From the measure screen, press MENU.

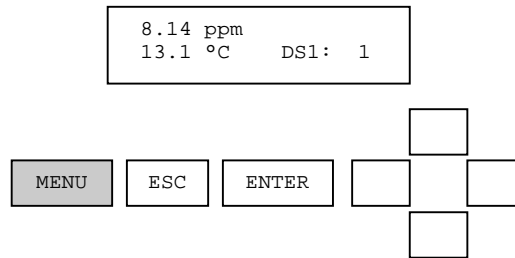

From the Main Menu, use the up/down arrows to select Calibrate. Then press ENTER.

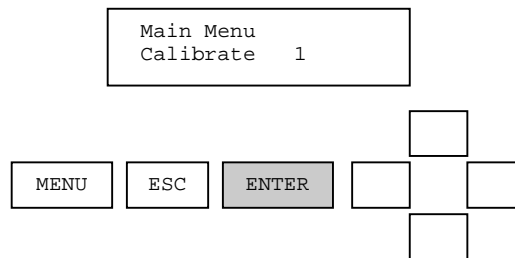

From the Calibrate Menu, use the up/down arrows to select Air. Then press ENTER.

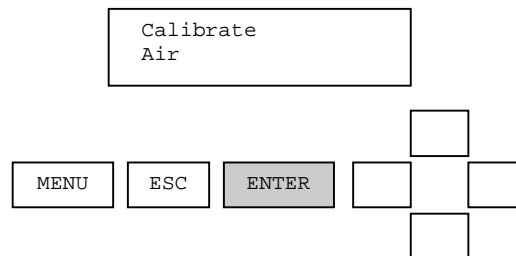

The current sensor value is dynamically displayed and the user is prompted to be sure the measurement is ready for calibration before proceeding. When ready, press the ENTER key.

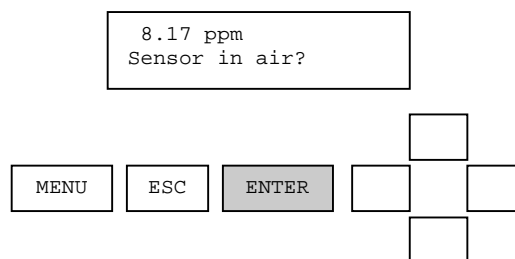

Once the actual air calibration has been initiated; the display will indicate that a calculation is progressing. During the calculation it is important that nothing disturb the measurement sample. To abort the calibration during this calculation, press ESC.

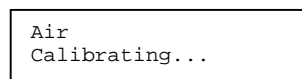

When the calibration calculation is complete, the result will be displayed on the second line of the display. If the calibration is successful, the message will be CAL OK. If the calibration is not successful, the message will be CAL FAIL. In either case, press ENTER to continue.

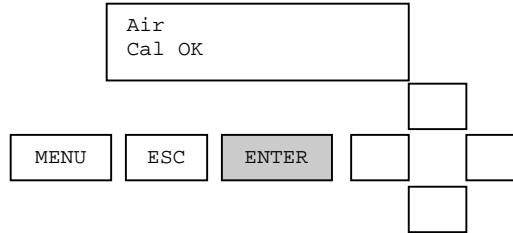

If the calibration is successful, pressing ENTER will return to the measure screen. If the calibration is not successful, pressing ENTER will return to the beginning of the 1-point sample calibration. Reasons for calibration failure include a sample that is not in the correct measurement range or is changing in value too quickly.

6.4. 1-Point Sample (Span) Calibration

The complete calibrate menu for the RDO Pro Optical Dissolved Oxygen system is shown below.

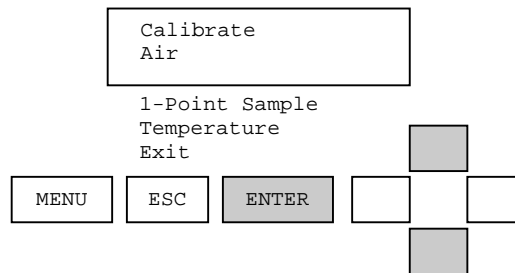

From the measure screen, press MENU.

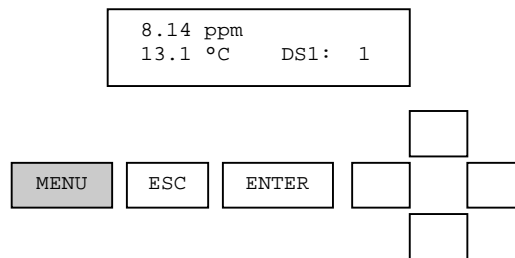

From the Main Menu, use the up/down arrows to select Calibrate. Then press ENTER.

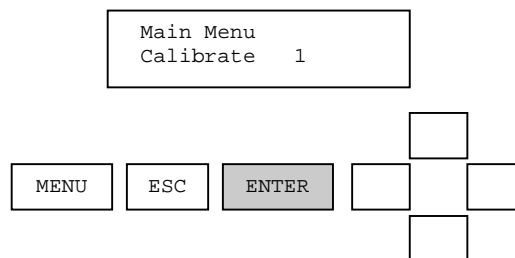

From the Calibrate Menu, use the up/down arrows to select 1-Point Sample. Then press ENTER.

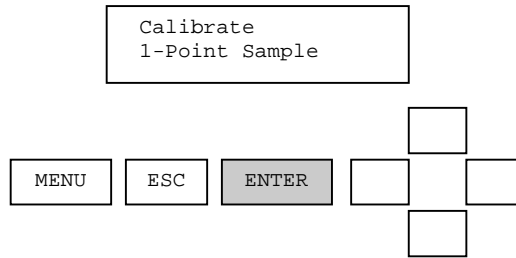

The current sensor value is dynamically displayed and asks the user to be sure the measurement is ready for calibration before proceeding. When ready, press the ENTER key.

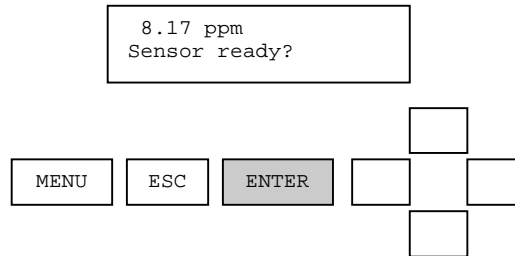

The calibration value can be adjusted with the arrow keys. Use the up/down arrows for fine adjust and the left/right arrows for coarse adjust. After the calibration value is adjusted to the desired value, press the ENTER key.

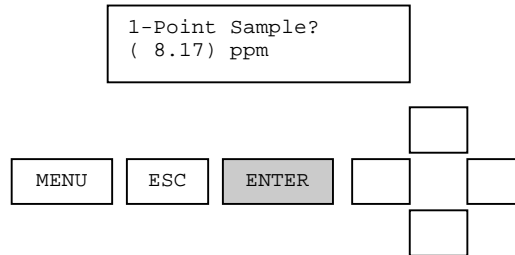

Once the actual 1-point sample calibration has been initiated; the display will indicate that a calculation is progressing. During this calculation it is important that nothing disturb the measurement sample. To abort the calibration during this calculation, press ESC.

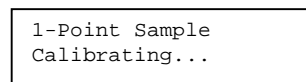

When the calibration calculation is complete, the result will be displayed on the second line of the display. If the calibration is successful, the message will be CAL OK. If the calibration is not successful, the message will indicate the reason for the failure. In either case, press ENTER to continue.

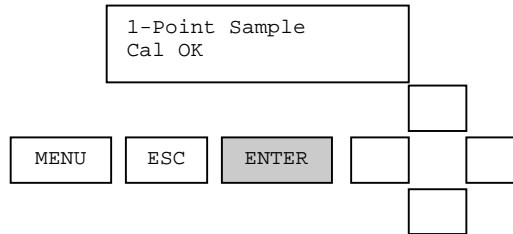

If the calibration is successful, pressing ENTER will return to the measure screen. If the calibration is not successful, pressing ENTER will return to the beginning of the 1-point sample calibration. Reasons for calibration failure include a sample that is not in the correct measurement range or is changing in value too quickly.

6.5. Temperature Calibration

Press the ENTER key from the TEMPERATURE calibration menu to initiate the calibration process.

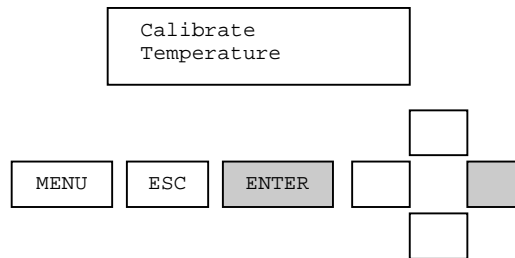

When the temperature calibration procedure is started, the analog output is placed into hold mode. The user is prompted to prepare the sensor. The temperature value is dynamically updated during this step.

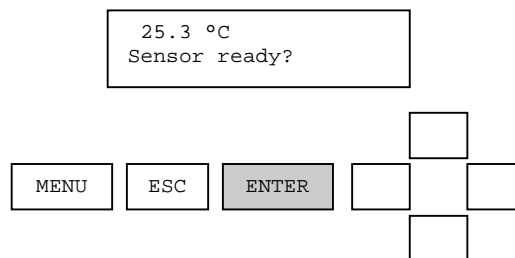

When the sensor is ready, the ENTER key is pressed and the user is presented with a calibration value for editing. Please note that it is best to calibrate temperature when the sensor and the process are at equilibrium.

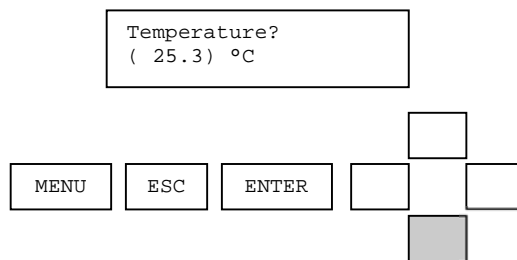

When the value has been edited as desired, the enter key is pressed and the calibration of the point is started.

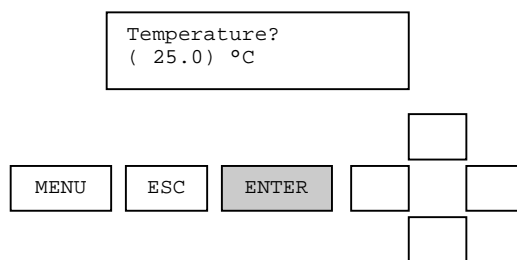

During this time, the calibration procedure can be aborted by pressing the escape key.

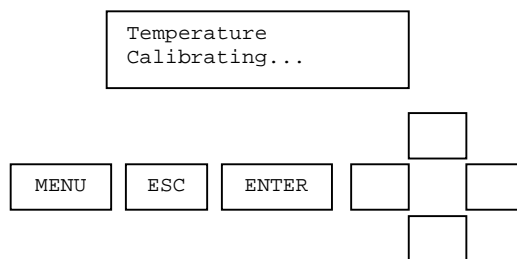

After the calibration point has been stored, the user is prompted to confirm a successful calibration procedure.

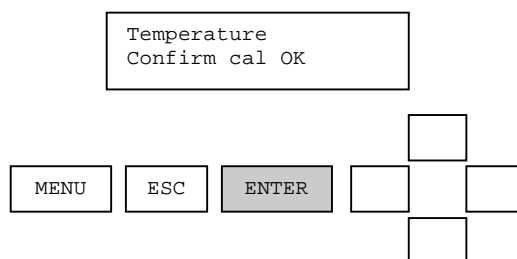

When the enter key is pressed, the analog output is placed into active mode and the monitoring of sensor and temperature values is resumed. This successfully completes the temperature calibration procedure.

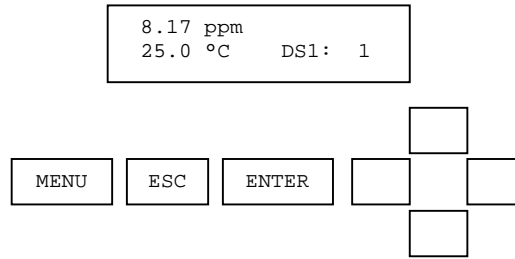

If an error occurs during calibration that causes the procedure to fail, the reason for the failure will be shown. When the enter key is pressed, the calibrate menu is displayed. This ends the temperature calibration procedure. The user has the option of repeating the procedure if desired.

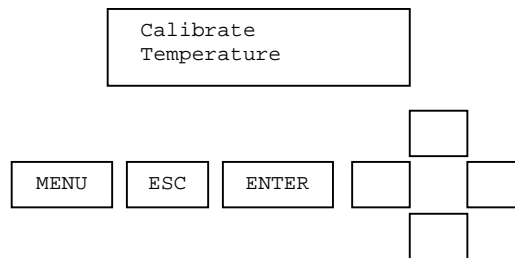

6.6. Configuration

The complete configure menu is shown below.

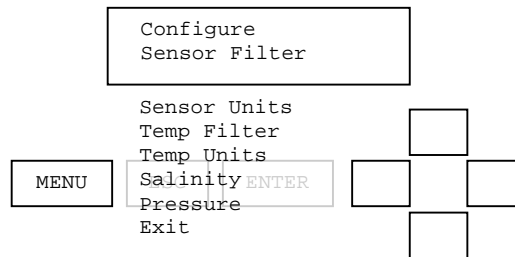

From the measure screen, press MENU.

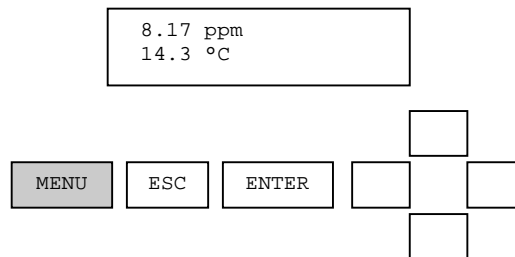

From the Main Menu, use the up/down arrows to select Configure. Then press ENTER.

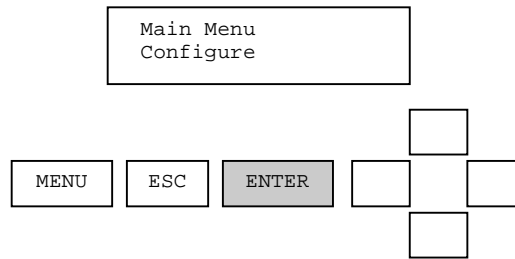

From the Configure menu, use the up/down arrows to select Sensor Filter. Then press ENTER.

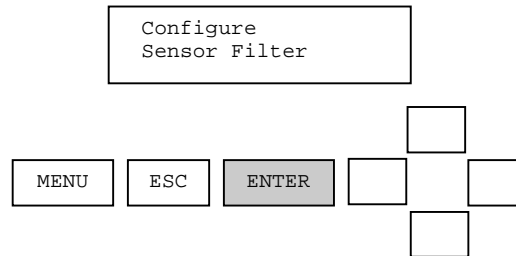

Edit the sensor filter with the up/down arrows. Press ENTER to select a new filter value. Press ESC to abort the new sensor value. The temperature filter edit screen works the same way.

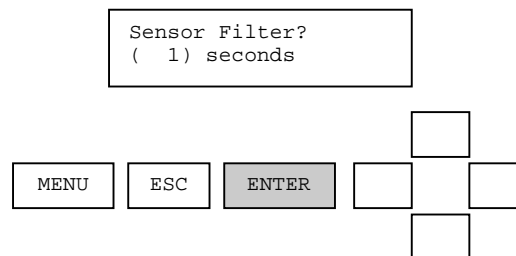

The Temperature units selection offers °C and °F in the edit screen.

6.7. Analog Output Overview

The analog output menu is used to setup the 4 milliamp to 20 milliamp analog output in the AV38. This function allows the following assignments:

- **Parameter:** Assign either DO or temperature to the output.
- **4 mA Value:** Assign the lowest value of DO or temperature to be reported.
- **20 mA Value:** Assign the highest value of DO or temperature to be reported.
- **Calibrate:** Use an external ammeter to calibrate the output for precise current readings.

When the AV38 is configured with two current outputs, then the main menu list shows “Analog Output 1” and “Analog Output 2”. The menu system for each output is identical.

Note: During calibration, the analog output is held at its present value.

Refer to the AV38 (MAN018AV38) Manual for detailed current output operation and setup.

6.8. Relay Function Overview

Relay A and Relay B are optional features on the AV38. Relays are Form C with normally open and normally closed contacts – 120 Volts, 3 Amps. Connections are made with the optional terminal block on the left side of the back panel.

When installed, configuration of relay action is accessed through the “Relay A” and “Relay B” in the main menu.

Top-level configuration of the relays is as follows:

- **Set Function:** Sets the relay function for alarm, control or wash operation.
- **Parameter:** Assigns either sensor (DO) or temperature to the relay function.
- **Activation:** Configures the relay activation setpoints, deadbands and on/off delays settings.

The activation parameters depend on which function is selected.

- When set for ALARM the relays will activate based on the settings of low and high limits.
- When set for CONTROL the relays will activate based on the settings of phase and a single setpoint.
- When set for WASH the relay will activate based on programmed interval, duration and off-delay.

Alarm and Control settings allow fine-tuning of activation criteria with deadband and delay functions. Activation parameters for Alarm, Control and Wash functions are listed in the table below.

ALARM	CONTROL	WASH
Set Low Alarm	Set Phase	Set Interval
Set High Alarm	Set Setpoint	Set Duration
Set Low Deadband	Set Deadband	Set Off-Delay
Set High Deadband	Set Off-Delay	Exit
Set Off-Delay	Set On-Delay	
Set On-Delay	Exit	
Exit		

Refer to the AV38 Manual for detailed relay operation and setup.

7. Modbus Register Map

When a RDO Pro Optical Dissolved Oxygen System is connected directly to a PLC, all measurement, calibration, configuration and diagnostic functions are accessible by any user interface that is also connected to the network.

Modbus uses a register map of floating-point, integer and ASCII measure, calibrate and configure commands.

The probe register map is defined in the table below. If an attempt is made to read or write a register that is not defined in the register map, the probe returns an exception response with error code 0x02 (illegal data address).

If the controller attempts to write to a read-only register, the probe returns an exception response with error code 0x82 (read-only register).

If the controller attempts to write an invalid register or field value, the probe returns an exception response with error code 0x84 (invalid write value).

Register Number	Register Size	Data Type	Access	Description
41001	1	USHORT	R	Communications Status
41002	1	USHORT	R	Calibration Status
41003	1	USHORT	R	Sensor Memory Status
41004	1	USHORT	R	Configuration Memory Status
41005	1	USHORT	R	Calibration Memory Status
41006	1	USHORT	R	Run Status
42001	2	FLOAT	R	DO Sensor Value
42003	2	FLOAT	R	Temperature Value
42005	2	FLOAT	R/W	Cal Sensor 1-Point Sample Value (mg/L)
42009	2	FLOAT	R/W	Cal Temperature 1-Point Sample Value (°C)
42023	2	FLOAT	R/W	DO Salinity (mS/cm)
42025	2	FLOAT	R/W	DO Barometric Pressure (mmHg)
43001	1	SHORT	R	DO Sensor Value
43002	1	SHORT	R	Temperature Value
43003	1	SHORT	R/W	Cal Sensor 1-Point Sample Value (mg/L)
43005	1	SHORT	R/W	Cal Temperature 1-Point Sample Value (°C)
43009	1	USHORT	R/W	Cal Sensor in Air
43011	1	USHORT	R/W	Cal Abort
43012	1	SHORT	R/W	DO Salinity (mS/cm)
43013	1	SHORT	R/W	DO Barometric Pressure (mmHg)
43017	1	USHORT	R/W	Sensor Units
43018	1	USHORT	R/W	Sensor Filter
43019	1	USHORT	R/W	Temperature Units
43020	1	USHORT	R/W	Temperature Filter
43022	1	USHORT	R/W	Modbus Slave Address
43023	1	USHORT	R/W	Modbus Baud Rate
43024	1	USHORT	R/W	Modbus Parity

Register Number	Register Size	Data Type	Access	Description
43025	1	USHORT	R/W	PLC Data Type
44001	1	USHORT	R	Sensor Value Scale Factor
44002	1	USHORT	R	Temperature Value Scale Factor
44003	1	SHORT	R	Cal Sensor 1-Point Sample Value SF
44005	1	SHORT	R	Cal Temperature 1-Point Value SF
44012	1	USHORT	R	DO Salinity Scale Factor
44013	1	USHORT	R	DO Barometric Pressure Scale Factor
45001	16	STRING	R/W	Main Serial Number
45017	4	STRING	R	DataStick Code Version
45021	1	USHORT	R/W	Node Address
45022	1	USHORT	R	Sensor Type
45023	1	USHORT	R	Calibration Type
45024	1	USHORT	R	Comms Adapter Code Version
47001	2	ULONG	R	Cap Expiration Time

Note: Registers 48580-48589 and 49000-49199 are reserved for factory use.

7.1. Data Formats

The MODBUS protocol defines 8-bit byte and 16-bit register fields within messages and commands; however, it does not define the format of more complex data types. Defined below are the data types used by the probe. All multiple register formats must be read or written within a single command.

Type	Registers	Bytes	Description
BYTE	--	1	8-bit unsigned integer
SHORT	1	2	16-bit 2's-complement signed integer
USHORT	1	2	16-bit unsigned integer
LONG	2	4	32-bit 2's-complement signed integer
ULONG	2	4	32-bit unsigned integer
FLOAT	2	4	32-bit IEEE floating-point value
STRING	N	2 * N	2 * N consecutive characters

All data types in this section are shown in the default big endian format (most significant byte first). The byte order within the registers of the FLOAT data type may be changed by writing to the PLC Data Type register.

Byte

An 8-bit unsigned integer contained in a single byte. Used within command and response messages. Not used as a register format.

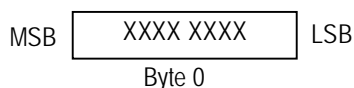

Short

A 16-bit two's-complement signed integer contained in a single register data address.

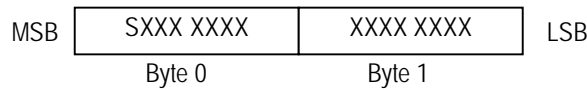

Where: 'S' = sign bit.

Unsigned Short

A 16-bit unsigned integer contained in a single register data address. Individual bits can be manipulated with the mask write register command.

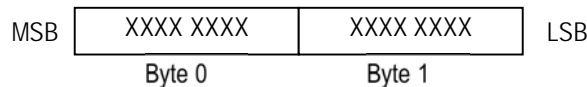

Long

A 32-bit two's-complement signed integer contained in two register data addresses.

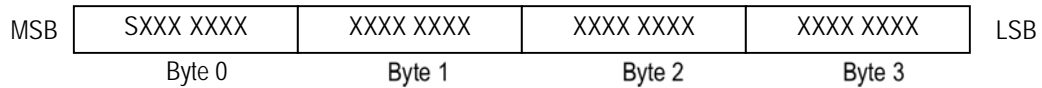

Where: 'S' = sign bit.

Unsigned Long

A 32-bit unsigned integer contained in two register data addresses.

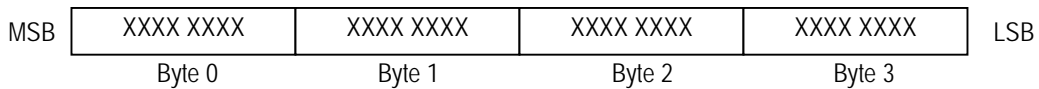

Float

A 32-bit IEEE 754 floating-point value with 1 sign bit (S), an 8-bit exponent (X), and a 23-bit mantissa (M).

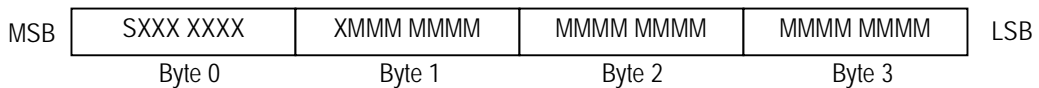

String

A string consists of a field of 2 * N consecutive characters. For example, a 16-register string contains 32 ASCII encoded characters. A termination character is not required. When reading or writing a string, all registers in the string must be transmitted. If the string to be written does not require the full field length, the extra characters must be padded with the value 0x00 to reach the full length.

7.2. DO Sensor Registers

DO Sensor Floating-Point Value

Register Address: 42001
Register Size: 2
Data Type: FLOAT
Access: Read-only

This register returns the current DO sensor value as a floating-point number. The value is reported in the selected sensor units and adjusted for the current value of temperature, salinity and barometric pressure. The DO sensor value is filtered according to the DO sensor filter parameter. If the value is not ready (the Communications Status Register returns 0) the probe returns NAN (not a number).

DO Sensor Integer Value

Register Address: 43001
Register Size: 1
Data Type: SHORT
Access: Read-only

This register returns the current DO sensor value as a 16-bit signed integer. The integer value is calculated by multiplying the floating-point sensor value by the DO sensor value scale factor. If the value is not ready (the Communications Status Register returns 0) the probe returns 0.

DO Sensor Value Scale Factor

Register Address: 44001
Register Size: 1
Data Type: USHORT
Access: Read-only

This register specifies the scale factor of the DO Sensor Integer Value. If mg/L units are specified, this register returns 100 (Integer = (Float + 0.005) * 100). If percent saturation units are specified, this register returns 10 (Integer = (Float + 0.05) * 10).

DO Sensor Units

Register Address: 43017

Register Size: 1

Data Type: USHORT

Access: Read/Write

Default Value: 0

Supported Values: 0 to 1

This register specifies the DO units of measure. Units of measure are assigned using the integer value in the following table.

Integer Value	Units
0	mg/L (ppm)
1	% saturation

DO Sensor Filter

Register Address: 43018

Register Size: 1

Data Type: USHORT

Access: Read/Write

Default Value: 1 second

Supported Values: 0 to 100 seconds

This register specifies the filter constant of the DO sensor. This is the number of seconds required to reach 90% of the final value when the reading changes. A setting of zero seconds specifies unfiltered readings.

DO Salinity Floating-Point Value

Register Address: 42023

Register Size: 2

Data Type: FLOAT

Access: Read/Write

Default Value: 0 mS/cm

Supported Values: 0 to 999.9 mS/cm

This register specifies the salinity compensation for the DO sensor in terms of specific conductivity using the floating-point format.

DO Salinity Integer Value

Register Address: 43012
Register Size: 1
Data Type: SHORT
Access: Read/Write
Default Value: 0
Supported Values: 0 to 999.9 mS/cm

This register specifies the salinity compensation for the DO sensor in terms of specific conductivity using the integer format. The value is read and written as the floating-point value multiplied by the DO Salinity Scale Factor.

DO Salinity Scale Factor

Register Address: 44012
Register Size: 1
Data Type: USHORT
Access: Read-only

This register specifies the scale factor of the DO Salinity Integer Value. This register returns 10 (Integer = (Float + 0.05) * 10).

DO Barometric Pressure Floating-Point Value

Register Address: 42025
Register Size: 2
Data Type: FLOAT
Access: Read/Write
Default Value: 760 mmHg
Supported Values: 539.2 to 792.4 mmHg

This register specifies the barometric pressure compensation for the DO sensor in millimeters of Mercury (mmHg) using the floating-point format.

DO Barometric Pressure Integer Value

Register Address: 43013
Register Size: 1
Data Type: SHORT
Access: Read/Write
Default Value: 760 mmHg
Supported Values: 539.2 to 792.4 mmHg

This register specifies the barometric compensation for the DO sensor in millimeters of Mercury (mmHg) using the 16-bit signed integer format. The value is read and written as the floating-point value multiplied by the DO Barometric Pressure Scale Factor.

DO Barometric Pressure Scale Factor

Register Address: 44013

Register Size: 1

Data Type: USHORT

Access: Read-only

This register specifies the scale factor of the DO Barometric Pressure Integer Value. This register returns 10 (Integer = (Float + 0.05) * 10).

Dissolved Oxygen Concentration Equations

DO concentration is internally calculated in mg/L. Conversion to other units is as follows:

$$\mu\text{g/L} = 1000 * \text{mg/L}$$

Oxygen concentration C_o (mg/L) is calculated as:

$$C_o = 31.9988 \times 1E6 \times (\rho P_o / k_o M) (1 - \Theta_o) \times S_c$$

Where:

P_o is the partial pressure of O_2 in atmospheres.

$$P_{\text{torr}} = 759.999876 \times P_{\text{atm}}$$

S_c is the salinity correction:

$$\ln S_c = S(B_0 + B_1 T_s + B_2 T_s^2 + B_3 T_s^3) + C_0 S^2$$

$$B_0 = -6.246090 \times 10^{-3}$$

$$B_1 = -7.423444 \times 10^{-3}$$

$$B_2 = -1.048635 \times 10^{-2}$$

$$B_3 = -7.987907 \times 10^{-3}$$

$$C_0 = -4.679983 \times 10^{-7}$$

T_s is the scaled temperature:

$$T_s = \ln [(298.15 - t) / (273.15 + t)]$$

t is temperature in degrees C

S is the salinity in PSU¹

k_o is Henry's constant:

$$\ln k_o = 3.71814 + (5596.17/T) - (1,049,668/T^2)$$

T is temperature in Kelvin.

Θ_o is the negative of the second pressure coefficient:

$$\Theta_o = 0.000975 - (1.426 \times 10^{-5}t) + (6.436 \times 10^{-8} t^2)$$

t is temperature in degrees C

¹ PSU = Practical Salinity Units - the conductivity ratio of a sea water sample to a standard KCl solution

ρ is the density of water in g/cm³:

$$\ln \rho = -0.589581 + (326.785/T) - (45,284.1/T^2)$$

T is the temperature in Kelvin.

Molar mass of water: M = 18.0152 g/mole

References:

Benson and Krause, Jr., 1980. The concentration and isotopic fractionation of gases dissolved in freshwater in equilibrium with the atmosphere. *Limnol, Oceanogr*, 25(4), 662-671.

Gordon and Garcia, 1992. Oxygen Solubility in Seawater: Better Fitting Equations. *Limnol, Oceaogr*, 37(6), 1307-1312.

Dissolved Oxygen, % Saturation Equations

$$O_2\%Sat = O_2Reading / O_2100\%Sat$$

Where:

O₂ Reading is the mg/L reading from the RDO sensor.

O₂ 100% Sat is the theoretical saturation value in mg/L and is derived as:

$$O_2100\%Sat = 31.9988 \times 10^6 \times \rho \frac{[0.20946 \times (P - P_{ww})]}{k_o M} \times (1 - \Theta_o P) \times S_c$$

Where:

$k_o M$

ρ is the density of water in g/cm³:

$$\ln \rho = -0.589581 + (326.785/T) - (45,284.1/T^2)$$

T is the temperature in Kelvin.

P is the atmospheric pressure in atm.

P_{ww} is the partial pressure of water vapor at saturation in atm:

$$\ln P_{ww} = 11.8571 - (3,840.70/T) - (216,961/T^2)$$

k_o is Henry's constant:

$$\ln k_o = 3.71814 + (5596.17/T) - (1,049,668/T^2)$$

T is the temperature in Kelvin.

Molar mass of water: M = 18.0152 g/mole

Θ_o is the negative of the second pressure coefficient:

$$\Theta_o = 0.000975 - (1.426 \times 10^{-5}t) + (6.436 \times 10^{-8}t^2)$$

Where t is temperature in degrees C.

S_c is the salinity correction:

$$\ln S_c = S(B_0 + B_1T_s + B_2T_s^2 + B_3T_s^3) + C_0S^2$$

$$B_0 = -6.246090 \times 10^{-3}$$

$$B_1 = -7.423444 \times 10^{-3}$$

$$B_2 = -1.048635 \times 10^{-2}$$

$$B_3 = -7.987907 \times 10^{-3}$$

$$C_0 = -4.679983 \times 10^{-7}$$

T_s is the scaled temperature:

$$T_s = \ln [(298.15 - t) / (273.15 + t)]$$

Where t is temperature in °C

S is the salinity in PSU

References:

Benson and Krause, Jr., 1980. The concentration and isotopic fractionation of gases dissolved in freshwater in equilibrium with the atmosphere. *Limnol, Oceanogr*, 25(4), 662-671.

Calibration Calculations

Calibrated oxygen reading:

$$O_{2RC} = C_0 + C_1 \times O_{2RU}$$

Where:

$$C_1 = (O_2100\%Sat) / (O_{2RUS} - O_{2RUZ})$$

$$C_0 = -C_1 \times O_{2RUZ}$$

Where:

O₂100%Sat is the theoretical 100% saturation point

O_{2RUS} is the un-calibrated reading at 100% saturation

O_{2RUZ} is the un-calibrated reading at 0% saturation

References:

Standard Methods for the Examination of Water and Wastewater, 20th Ed, 2008. 4500-0 C. Azide Modification. American Public Health Association. USA.

7.3. Temperature Registers

Temperature Floating-Point Value

Register Address: 42003

Register Size: 2

Data Type: FLOAT

Access: Read-only

This register returns the current temperature value as a floating-point number. The value is reported in the selected temperature units and filtered according to the temperature filter parameter. If the value is not ready (the Communications Status Register returns 0) the probe returns NAN (not a number).

Temperature Integer Value

Register Address: 43002
Register Size: 1
Data Type: SHORT
Access: Read-only

This register returns the current temperature value as a 16-bit signed integer. The integer value is calculated by multiplying the floating-point temperature value by the temperature value scale factor. If the value is not ready (the Communications Status Register returns 0) the probe returns 0.

Temperature Value Scale Factor

Register Address: 44002
Register Size: 1
Data Type: USHORT
Access: Read-only

This register specifies the scale factor of the temperature value. This register returns 10 (Integer = (Float + 0.05) * 10).

Temperature Units

Register Address: 43019
Register Size: 1
Data Type: USHORT
Access: Read/Write
Default Value: 0
Supported Values: 0 to 1

This register specifies the units of measure of the probe's temperature sensor. Units of measure are assigned using the integer value in the following table.

Integer Value	Units
0	°C
1	°F

Temperature Filter

Register Address: 43020
Register Size: 1
Data Type: USHORT
Access: Read/Write
Default Value: 1 second
Supported Values: 0 to 100 seconds

This register specifies the filter constant of the probe's temperature sensor. This is the number of seconds required to reach 90% of the final value when the reading changes. A setting of zero seconds specifies unfiltered readings.

7.4. Calibration Registers

Calibration Status

Register Address: 41002

Register Size: 1

Data Type: USHORT

Access: Read-only

The calibration status can contain the following values.

Value	Description
0	No sensor calibration
1	Calibration in progress
2	Calibration OK
3	Calibration failed, parameter failed to stabilize
7	Calibration failed, user-entered value too low (DO only)
10	Calibration failed, slope too high (DO only)
12	Calibration failed, offset too high (temperature only)

By default or after a write to the Cal Abort register, this register reports 0. After any type of calibration is initiated, the register reports 1. After a calibration completes successfully, the register reports 2. If a calibration fails, the register reports the appropriate value. The register is volatile and returns to zero if power is cycled.

Calibration Type

Register Address: 45023

Register Size: 1

Data Type: USHORT

Access: Read-only

This register returns the calibration type of the calibration in progress or the type of the last successful calibration. The register can contain the following values.

Value	Description
0	No sensor calibration
4	1-point sample calibration
7	Air calibration
10	Temperature calibration

The register is volatile and returns to zero if power is cycled.

Cal Sensor 1-Point Sample Float Value

Register Address: 42005
Register Size: 2
Data Type: FLOAT
Access: Read/Write
Default Value: 0.00
Supported Values: 1.00 to 10.00 mg/L

Writing a value to this register initiates a 1-point sample calibration of the DO sensor, resulting in a slope correction. The units are always mg/L regardless of the units set for the DO sensor output. This register is volatile and returns to zero if power is cycled.

Cal Sensor 1-Point Sample Integer Value

Register Address: 43003
Register Size: 1
Data Type: SHORT
Access: Read/Write
Default Value: 0
Supported Values: 1.00 to 10.00 mg/L

Writing a value to this register initiates a 1-point sample calibration of the DO sensor in the same manner as a write to the float value. The value must be scaled by the sample value scale factor specified in register 44003.

Cal Sensor 1-Point Sample Value Scale Factor

Register Address: 44003
Register Size: 1
Data Type: SHORT
Access: Read-only

This register specifies the scale factor of the Calibrate Sensor 1-Point Sample Integer Value. This register returns 100 (Float = Integer / 100).

Cal Temperature 1-Point Sample Float Value

Register Address: 42009
Register Size: 2
Data Type: FLOAT
Access: Read/Write
Default Value: 0.0
Supported Values: 5 to 50 °C

Writing a value to this register initiates a 1-point sample calibration of the temperature sensor, resulting in an offset correction. The units are always °C regardless of the units set for the temperature sensor output. This register is volatile and returns to zero if power is cycled.

Cal Temperature 1-Point Sample Integer Value

Register Address: 43005
Register Size: 1
Data Type: SHORT
Access: Read/Write
Default Value: 0
Supported Values: 5 to 50 °C

Writing a value to this register initiates a 1-point sample calibration of the temperature sensor, in the same manner as a write to the float value. The value must be scaled by the sample value scale factor specified in register 44005.

Cal Temperature 1-Point Sample Value Scale Factor

Register Address: 44005
Register Size: 1
Data Type: SHORT
Access: Read-only

This register specifies the scale factor of the Calibrate Temperature 1-Point Sample Integer Value. This register returns 10 (Float = Integer / 10).

Cal Sensor In Air

Register Address: 43009
Register Size: 1
Data Type: USHORT
Access: Read/Write

Writing any value to this register initiates an air calibration of the DO sensor. The probe must be placed in a 100% water saturated air environment. The reference concentration is computed as the theoretical concentration of oxygen in a 100% saturated environment at the current barometric pressure value and zero salinity. Always returns 0.

Cal Abort

Register Address: 43011
Register Size: 1
Data Type: USHORT
Access: Read/Write

Writing any value to this register aborts the current calibration and restores the previous calibration. If no calibration is in progress (the calibration status register is not 1), the write is ignored. Always returns 0.

Entering Calibration Registers

The sensor is calibrated using the following procedure:

1. Write to the appropriate calibration register.

2. Read the Calibration Status register. While the value is 1, the calibration is in progress. When the value changes from 1 to 2, the calibration is complete. If the value changes from 1 to 3 or greater, the calibration failed and the value in the Calibration Status register explains why.
3. To stop the calibration before it completes, write to the Cal Abort register.

7.5. Communication Registers

Communication Status

Register Address: 41001

Register Size: 1

Data Type: USHORT

Access: Read-only

On power-up, and until the first sensor values are available, this register returns 0 to indicate that communication is OK. After the first sensor values are available, this register returns 2 to indicate that data is valid. If the sensor cap is not installed or is expired, this register returns 0.

Modbus Slave Address

Register Address: 43022

Register Size: 1

Data Type: USHORT

Access: Read/Write

Default Value: 1

Supported Values: 1 to 247

This register specifies the probe address on the Modbus network. The address must be unique from all other devices on the network. The new address does not take effect until power to the probe is cycled.

Modbus Baud Rate

Register Address: 43023

Register Size: 1

Data Type: USHORT

Access: Read/Write

Default Value: 0 (19.2 kbps)

Supported Values: 0 to 9

The baud rate specifies the communication speed at which data is transferred between the controller and the probe. When this register is written, the response is provided using the old baud rate. The new baud rate does not take effect until power to the probe is cycled. Baud rates are assigned using the integer value in the following table.

Integer Value	Baud Rate (kbps)
0 (default)	19.2
1	1.2
2	2.4
3	4.8
4	9.6
5	14.4
6	19.2
7	28.8
8	38.4
9	57.6

Modbus Parity

Register Address: 43024

Register Size: 1

Data Type: USHORT

Access: Read/Write

Default Value: 0 (Odd)

Supported Values: 0 to 3

This register specifies the communication parity generation and checking between the controller and the probe. The new parity does not take effect until power to the probe is cycled. Parity is assigned using the integer value in the following table.

Integer Value	Parity
0 (default)	Odd
1	None
2	Odd
3	Even

PLC Data Type

Register Address: 43025

Register Size: 1

Data Type: USHORT

Access: Read/Write

Default Value: 1 (Little Endian Word Swap)

Supported Values: 0 to 3

This register specifies the byte order used to represent the floating-point data type. The sign, exponent, and mantissa of a 32-bit IEEE 754 floating-point number are organized into a 32-bit field as follows:

Byte 0	Byte 1	Byte 2	Byte 3
Bits 31-24	Bits 23-16	Bits 15-8	Bits 7-0
SXXX XXXX	XMMM MMMM	MMMM MMMM	MMMM MMMM

The byte order is assigned using the integer value in the following table.

Integer Value	Data Type	Register N		Register N+1	
		MSB	LSB	MSB	LSB
0	Little Endian	Byte 0	Byte 1	Byte 2	Byte 3
1	Little Endian Word Swap	Byte 2	Byte 3	Byte 0	Byte 1
2	Big Endian	Byte 3	Byte 2	Byte 1	Byte 0
3	Bit Endian Word Swap	Byte 1	Byte 0	Byte 3	Byte 2

7.6. Status Registers

Sensor Memory Status

Register Address: 41003

Register Size: 1

Data Type: USHORT

Access: Read-only

This register returns the sensor memory status. The register can contain the following values.

Value	Description
0	Sensor memory not functional
1	Sensor memory not valid
2	Sensor memory valid

Configuration Memory Status

Register Address: 41004

Register Size: 1

Data Type: USHORT

Access: Read-only

This register returns the configuration memory status. The register can contain the following values.

Value	Description
0	Configuration initialized
1	Configuration valid
2	Configuration valid and new sensor
4	Configuration valid but new version

Calibration Memory Status

Register Address: 41005
Register Size: 1
Data Type: USHORT
Access: Read-only

This register returns the calibration memory status. The register can contain the following values.

Value	Description
0	Calibration initialized
1	Calibration valid
2	Calibration valid but new version

Run Status

Register Address: 41006
Register Size: 1
Data Type: USHORT
Access: Read-only

This register returns the calibration memory status. The register can contain the following values.

Value	Description
0	System error
1	Sensor installation required
2	System OK

Main Serial Number

Register Address: 45001
Register Size: 16
Data Type: STRING
Access: Read/Write

This is a general-purpose string register intended to hold a user-programmed device serial number. By default, this register is the string representation of the factory serial number.

DataStick Code Version

Register Address: 451017
Register Size: 4
Data Type: STRING
Access: Read-only

This register returns the string representation of the application code version in the form "Rx.xx".

Node Address

Register Address: 45021
Register Size: 1
Data Type: USHORT
Access: Read/Write
Default Value: 0
Supported Values: 0 to 255

This is a general-purpose register intended to hold a user-programmed tracking number.

Sensor Type

Register Address: 45022
Register Size: 1
Data Type: USHORT
Access: Read-only

This register always returns the value 13.

Comms Adapter Code Version

Register Address: 45024
Register Size: 1
Data Type: USHORT
Access: Read-only

This register returns the major part of the application code version in the upper byte of the register, and the minor part in the lower byte of the register. For example, version 1.23 is represented as 0x0117 or decimal 279.

Cap Expiration Time

Register Address: 47001
Register Size: 2
Data Type: ULONG
Access: Read-only

This register returns the number of seconds remaining until the sensor cap expires. If the sensor cap is not present, zero is returned.

8. Specifications

Sensor type	Luminescent dissolved oxygen sensor
Transmitter/local display	Optional, not required
Range	0 to 20 mg/L (ppm) concentration 0 to 200% saturation
Accuracy (DO)	±0.1 mg/L, 0 to 8 mg/L ±0.2 mg/L, 8 to 20 mg/L
Response time, cap	T90: 30 sec T95: 37 sec @ 25°C
Resolution	0.01 mg/L
Usage life of cap	1 year from the first instrument reading
Shelf life of cap (install within 12 mo. of manufacture)	24 months from date of manufacture
Operating temperature	0° to 50°C (32° to 122°F)
IP rating	IP-67 with cap off, IP-68 with cap installed
Compliance	Heavy industrial, IEC 61000-6-2:2005
Storage conditions, cap	1° to 60°C (33° to 140°F), in factory container
Storage conditions, sensor	5° to 60° (23° to 140°F)
Salinity range	0 to 42 PSU, fixed or real-time capable
pH range	2 to 10 pH
Barometric range	507 to 1115 mbar, fixed or real-time capable
Internal mounting thread	1¼-11½ NPT
Communications	Modbus RTU (RS485)
Cable	10 m fixed stripped and tinned
Warranty sensor	3 years from date of manufacture
Warranty cap	2 years from date of manufacture

9. RDO Pro Optical Dissolved Oxygen System Order Matrix and Accessories

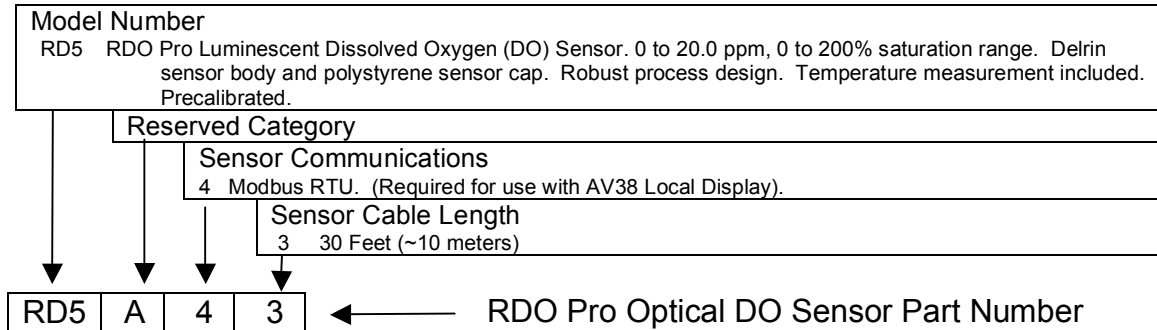

Interface Components	Description	Part Number
Profibus / RDO Pro & DataStick Sensor Gateway	Modbus RTU Sensors connect to Profibus DP	CA26R

Local Interface	Description (Suggested Configurations)	Part Number
AV38 NEMA 4X Display/Controller	One 4-20mA output, 24VDC. Two 4-20mA outputs, 2 Relays, 90-240 VAC.	AV38BB0A1 AV38CB0C2

Mounting Hardware	Description	Part Number
Immersion Assembly	7 ft PVC extension with junction box – RDO Sensors	MH3083-RD
Immersion Assembly w/Swivel Rail Mounting	7 ft PVC extension with junction box – RDO Sensors With swivel hand rail mount.	MH1242-RD
Immersion Assembly w/Swivel and Ball Float	7 ft PVC extension with junction box – RDO Sensors With swivel hand rail mount and inflatable float.	MH1252-RD
Ball Float Platform	Float Platform for up to 4 RDO Pro Sensors or DataSticks	MHFB02-RD
Wash Hardware	Attach air/water purge block to sensor body. Works with compressor & AV38 wash relay or PLC.	MH1222-RD
Wash Hardware	Attach air purge block to sensor body. Includes air compressor; works with AV38 wash relay or PLC.	MH5222-RD
Junction box Extension Cable	For extension cables. Terminal strip included. DataStick Extension cable	JBOXX01 DSECxx; xx=ft

NOTE: RDO Pro Sensor Body carries a 3-year warranty. Sensor caps, 2-years.

9.1. Accessories

Product	Description	Part Number
Sensor Cap	Replacement RDO Pro Optical DO Sensing Cap; includes o-rings and silicone grease (Replaced annually; 2-year warranty)	RDC1
Nose Cone	Replacement RDO Pro Sensor Nose Cone	RDN1
O-ring Kit	Replacement RDO Pro Sensor O-ring Kit	RDG1

10. Limited Warranty

WARRANTY/REPLACEMENT PLAN

Thermo Fisher Scientific warrants its products against material and workmanship defect for a period of one year from the date of shipment.

In the event that a defect is discovered during the warranty period, Thermo Fisher Scientific agrees, at its option, to repair or replace the defective product. Any product repaired or replaced under this warranty will be warranted only for the remainder of the original product warranty period.

This warranty does not apply to consumable products associated with this product including, but not limited to, chemical reagents and salt bridges.

Products may not be returned without authorization from Thermo Fisher Scientific. To obtain authorization, please call Thermo Fisher Scientific for a return material authorization number.

Limitations:

This warranty does not cover:

1. Damage caused by misuse, neglect (lack of appropriate maintenance), alteration, accident or improper application or installation.
2. Damage caused by any repair or attempted repair not authorized by Thermo Fisher Scientific.
3. Any product not used in accordance with the instructions furnished by Thermo Fisher Scientific.
4. Damage caused by acts of God, natural disaster, acts of war (declared or undeclared), acts of terrorism, work actions, or acts of any governmental jurisdiction.
5. Freight charges to return merchandise to Thermo Fisher Scientific.
6. Travel fees associated with on-site warranty repair.

This warranty is the sole expressed warranty made by Thermo Fisher Scientific in connection with its products. All other warranties, whether expressed or implied, including without limitation, the warranties of merchantability and fitness for a particular purpose, are expressly disclaimed.

The liability of Thermo Fisher Scientific shall be limited to the cost of the item giving rise to the claim. In no event shall Thermo Fisher Scientific be liable for incidental or consequential damages.

This warranty is the sole and complete warranty for Thermo Fisher Scientific. No person is authorized to make any warranties or representations on behalf of Thermo Fisher Scientific.

Thermo Fisher Scientific reserves the right to change or modify this warranty at any time.

11. Terms and Conditions

Terms and Conditions of Sale

The following terms and conditions will be presumed acceptable unless changes are made in writing and accepted by both parties in a reasonable amount of time.

Any standard or boilerplate terms and conditions supplied with a written purchase order will not be applicable unless accepted in writing by both parties.

Quotations: All quotations shall be in writing. Written quotations shall be valid for 30 days from the date issued. Verbal quotations or price lists are not valid.

Pricing: All pricing is in **US Dollars**. Thermo Fisher Scientific reserves the right to change pricing without notice.

Terms: Payment terms are **net 30 days** from the date of invoice with approved credit. Thermo Fisher Scientific reserves the right to deny credit or revoke previously extended credit. Past due accounts are subject to interest charges. Other acceptable payment terms are cash, certified check, money order, credit card or letter of credit confirmed by any United States of America bank. Other payment terms are not valid unless accepted in writing.

Sales taxes shall be included on the invoice unless a valid tax exemption certificate is supplied.

Return Material Authorization: Contact Thermo Fisher Scientific Customer Service for a Return Material Authorization (RMA) number. Items returned without an RMA number will be rejected.

All returned merchandise must be in unused, resalable condition, and must not be contaminated with hazardous materials.

Cancelled orders must be returned within 30 days of the date on the invoice and shall be subject to expenses incurred that may include, but are not limited to, inspection and restocking fees. Items returned within 60 days shall be subject to a restocking charge that is equal to 15% of the purchase price. Items returned after more than 60 days shall be subject to a restocking charge equal to 25% of the purchase price. Thermo Fisher Scientific reserves the right to reject any return that is not under warranty after 60 days. Non-stock items are normally not returnable.

Transportation: Orders are shipped FOB Thermo Fisher Scientific, or factory, by the most efficient means available. Appropriate charges, such as freight and insurance will be added to invoices. All shipments will be insured. Goods damaged in shipment must be reported by the recipient to the freight carrier for claims.

Thermo Fisher Scientific

Environmental Instruments

Process Water Instruments



North America

166 Cummings Center
Beverly, MA 01915 USA
Toll Free: 1-800-225-1480
Tel: 1-978-232-6000
Dom. Fax: 1-978-232-6015
Int'l Fax: 978-232-6031

Europe

P.O. Box 254, 3860 AG Nijkerk
Wallerstraat 125K, 3862 BN Nijkerk,
Netherlands
Tel: (31) 033-2463887
Fax: (31) 033-2460832

Asia Pacific

Blk 55, Ayer Rajah Crescent
#04-16/24, Singapore 139949
Tel: 65-6778-6876
Fax: 65-6773-0836

www.thermo.com/processwater

© 2009 Thermo Fisher Scientific Inc. All rights reserved.

258493-001 Rev. A 01-09