

GE
Sensing



Model CTF878
Clamp-On Tag Flowmeter

Programming Manual



GE
Sensing

Model CTF878

Clamp-On Tag Flowmeter



Programming Manual

910-254PA4

February 2009



Warranty

Each instrument manufactured by GE Sensing, Inc. is warranted to be free from defects in material and workmanship. Liability under this warranty is limited to restoring the instrument to normal operation or replacing the instrument, at the sole discretion of GE. Fuses and batteries are specifically excluded from any liability. This warranty is effective from the date of delivery to the original purchaser. If GE determines that the equipment was defective, the warranty period is:

- one year for general electronic failures of the instrument
- one year for mechanical failures of the sensor

If GE determines that the equipment was damaged by misuse, improper installation, the use of unauthorized replacement parts, or operating conditions outside the guidelines specified by GE, the repairs are not covered under this warranty.

The warranties set forth herein are exclusive and are in lieu of all other warranties whether statutory, express or implied (including warranties of merchantability and fitness for a particular purpose, and warranties arising from course of dealing or usage or trade).

Return Policy

If a GE Sensing, Inc. instrument malfunctions within the warranty period, the following procedure must be completed:

1. Notify GE, giving full details of the problem, and provide the model number and serial number of the instrument. If the nature of the problem indicates the need for factory service, GE will issue a RETURN AUTHORIZATION number (RA), and shipping instructions for the return of the instrument to a service center will be provided.
2. If GE instructs you to send your instrument to a service center, it must be shipped prepaid to the authorized repair station indicated in the shipping instructions.
3. Upon receipt, GE will evaluate the instrument to determine the cause of the malfunction.

Then, one of the following courses of action will then be taken:

- If the damage is covered under the terms of the warranty, the instrument will be repaired at no cost to the owner and returned.
- If GE determines that the damage is not covered under the terms of the warranty, or if the warranty has expired, an estimate for the cost of the repairs at standard rates will be provided. Upon receipt of the owner's approval to proceed, the instrument will be repaired and returned.

Table of Contents

Chapter 1: Programming Site Data

| | |
|---|------|
| Introduction | 1-1 |
| Powering UP | 1-1 |
| Using the Screen | 1-2 |
| Using the Keypad | 1-4 |
| Entering the Program Menu | 1-6 |
| Entering Transducer Parameters | 1-7 |
| Parameters for Typical Transducers | 1-9 |
| Parameters for Special Transducers | 1-9 |
| Entry Confirmation | 1-10 |
| Entering Pipe Parameters. | 1-10 |
| Entering Fluid Types and Speeds | 1-14 |
| Entering Path Parameters. | 1-15 |
| Path Parameters for Clamp-On Transducers. | 1-16 |
| Entering Analog Inputs | 1-17 |
| Entering Analog Outputs | 1-20 |
| Entering Digital Outputs | 1-23 |
| Entering Alarm Parameters | 1-25 |
| Entering Standard Volume Data | 1-27 |
| Entering Settings. | 1-27 |
| Entering Inputs | 1-28 |
| Entering User Functions | 1-30 |
| Entering a Calibration Factor | 1-33 |

Chapter 2: Displaying and Configuring Data

| | |
|---|------|
| Introduction | 2-1 |
| Format Option | 2-2 |
| View Option. | 2-3 |
| Limits Option. | 2-3 |
| Measurement Option | 2-5 |
| Customizing the Display Screen | 2-6 |
| Specifying the Number of Displayed Parameters | 2-7 |
| Customizing Softkeys | 2-8 |
| Accessing Meter Data —The About Option | 2-10 |

Table of Contents (cont.)

Chapter 3: Creating and Managing Sites

| | |
|--|------|
| Introduction | 3-1 |
| Site Manager | 3-2 |
| Creating a New Site | 3-4 |
| Opening an Existing Site | 3-6 |
| Saving a Site | 3-7 |
| Saving a Site with a Different Name | 3-8 |
| Refreshing a Site | 3-8 |
| Renaming a Site | 3-9 |
| Deleting a Site | 3-10 |
| Listing Files by Name | 3-11 |
| Listing Files in Chronological Order | 3-11 |

Chapter 4: Programming Meter Settings

| | |
|--|------|
| Introduction | 4-1 |
| Entering the Meter Menu | 4-1 |
| Selecting Measurement Units | 4-2 |
| Entering Date and Time | 4-3 |
| Changing Date and Time Appearance | 4-4 |
| Adjusting Contrast | 4-6 |
| Setting Backlight Timeout | 4-7 |
| Changing Communications Parameters | 4-8 |
| Resetting Forward and Reverse Totals | 4-10 |
| Setting Up User Tables | 4-11 |

Table of Contents (cont.)

Chapter 5: Logging Data

| | |
|--|------|
| Introduction | 5-1 |
| Entering the Logging Menu. | 5-1 |
| Log Manager | 5-2 |
| File Menu. | 5-3 |
| Setting up a New Log | 5-4 |
| Copying (Cloning) a Selected Log | 5-9 |
| Renaming a Log | 5-9 |
| Deleting a Log. | 5-10 |
| Deleting All Logs | 5-10 |
| Refreshing the Log Manager Screen. | 5-10 |
| Log Menu | 5-11 |
| Stopping (Pausing) a Log | 5-11 |
| Restarting a Log | 5-11 |
| Ending a Log. | 5-12 |
| Stopping All Logs | 5-12 |
| Restarting All Logs | 5-12 |
| Ending All Logs | 5-12 |
| View All Sites. | 5-12 |
| View Menu | 5-13 |
| Displaying Log Details | 5-13 |
| Displaying Log Data in Graphical Form. | 5-14 |
| Displaying Log Data in Spreadsheet Form. | 5-17 |
| Sort Menu | 5-18 |
| Listing Logs by Name. | 5-18 |
| Listing Logs in Chronological Order | 5-18 |

Chapter 1

Programming Site Data

| | |
|---------------------------------------|------|
| Introduction..... | 1-1 |
| Powering UP | 1-1 |
| Using the Screen..... | 1-2 |
| Using the Keypad | 1-4 |
| Entering the Program Menu | 1-6 |
| Entering Transducer Parameters..... | 1-7 |
| Entering Pipe Parameters | 1-10 |
| Entering Fluid Types and Speeds | 1-14 |
| Entering Path Parameters | 1-15 |
| Entering Analog Inputs..... | 1-17 |
| Entering Analog Outputs | 1-20 |
| Entering Digital Outputs..... | 1-23 |
| Entering Alarm Parameters..... | 1-25 |
| Entering Standard Volume Data..... | 1-27 |
| Entering User Functions..... | 1-30 |
| Entering a Calibration Factor | 1-33 |

Introduction

This chapter provides instructions for entering the programming data required to place the CTF878 flowmeter into operation. Before the CTF878 can begin taking measurements and displaying valid data, the current system and pipe parameters must be entered. Additional programming options provide access to the more advanced features of the CTF878, but this information is not required to begin taking measurements.

Powering UP

Immediately upon power up the CTF878 emits a short beep and displays a “PCI Loader” message. It then validates the instrument programming, and displays the GE Sensing logo and the software version. If the meter fails any of these tests, contact the factory.

After the meter conducts all the self checks, the screen then appears similar to the one shown in Figure 1-1 below.

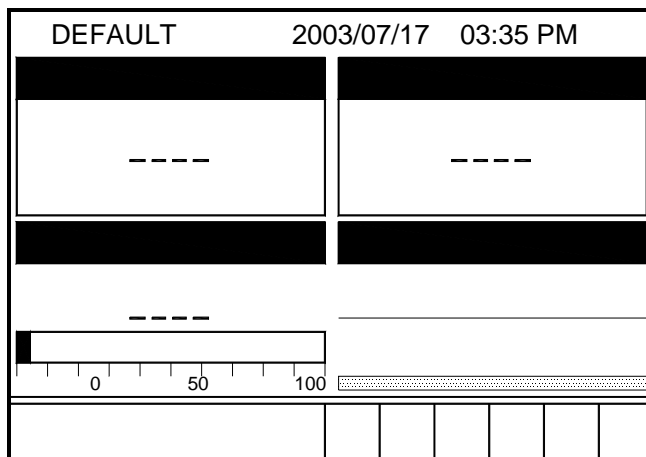

Figure 1-1: Screen After Powering ON

Using the Screen

The essential features for operating the CTF878 are the screen and keypad. Although these features are common, the CTF878 design offers particular features to simplify and speed operation. The new menu system is very user-friendly; program information is now located on tabbed forms instead of on a long, linear menu.

The primary function of the screen is to display information in order for you to take measurements accurately and easily. The CTF878 screen consists of those parts shown in Figure 1-2 below.

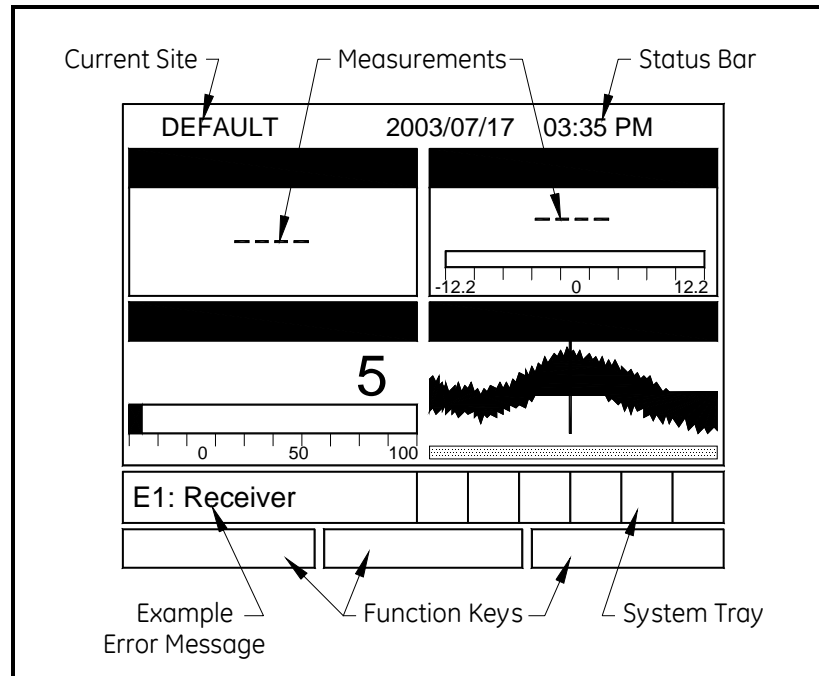

Figure 1-2: CTF878 Screen in Operate Mode



The top line of the screen is the status bar, which normally displays the time and date. However, when you press [MENU] (the menu key), the menu bar replaces the status line.

The middle of the screen is the work area, which displays the measured parameters, numeric measurements, and both bar and line graphs. When you enter a selection on the menu bar, this area displays menu prompts. A line at the bottom of the area also displays error code messages, which are described in more detail in the *Service Manual*.

Using the Screen (cont.)

The system tray displays icons that indicate meter operations not otherwise shown. Table 1-1 below lists the icons and their meanings.

Table 1-1: Icons in the System Tray

| Icon | Function | Meaning |
|---|----------|--|
|  | Alert | The meter encountered an error in operation. |
|  | Log | A log is running (marks). |
|  | Log | A log is pending (no marks). |

The bottom of the screen displays the three function key options: F1, F2 and F3. These keys have different functions, depending on the task being performed. The initial, factory setup, configuration for these keys is as follows:

- F1 = Transducer
- F2 = Diagnostics
- F3 = Save Now

Using the Keypad

The CTF878 keypad contains 24 keys that are labeled with their functions. The complete keypad is illustrated in Figure 1-3 below and a detailed description of the functions for each of the 24 keys is listed in Table 1-2 on page 1-5.

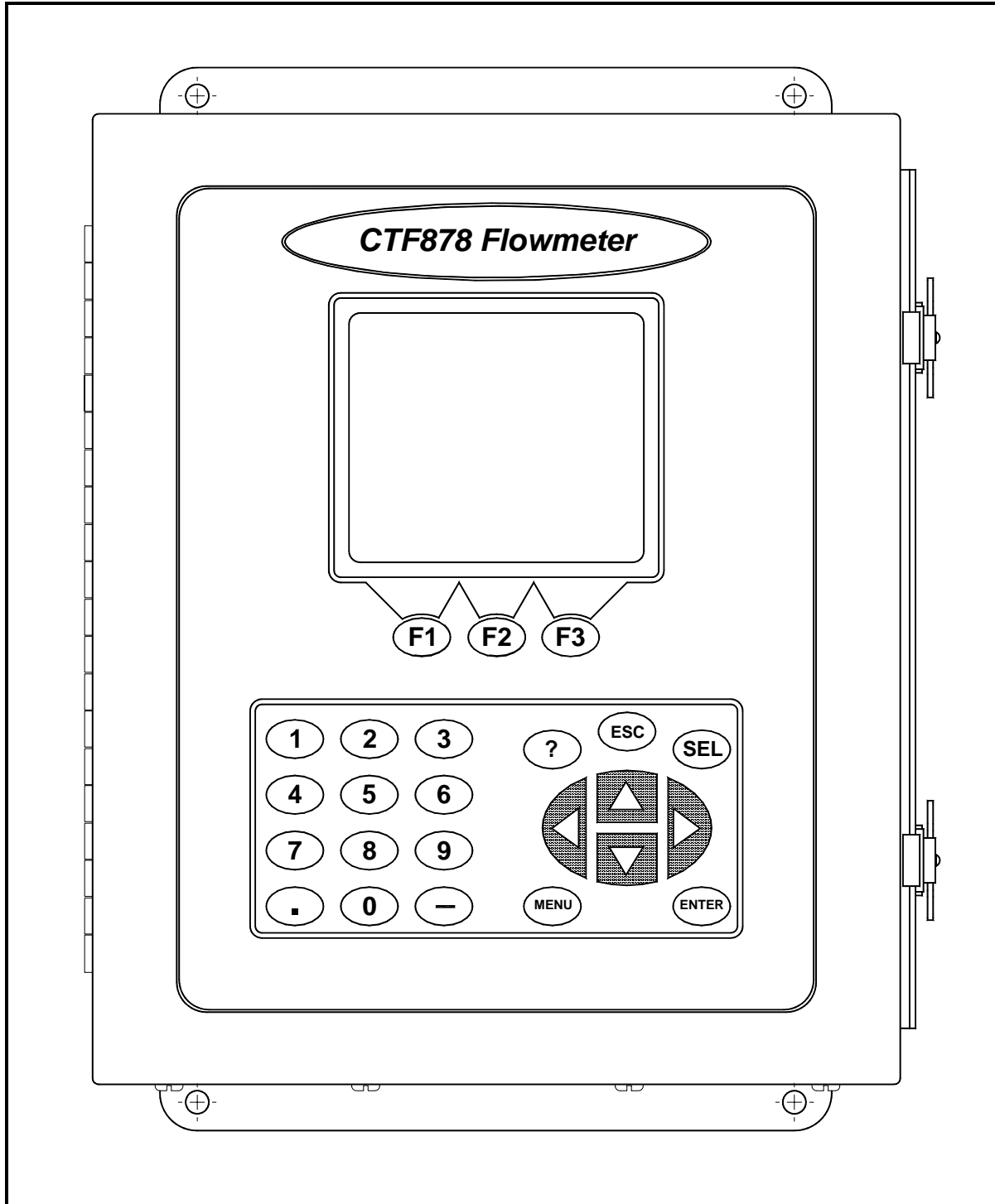
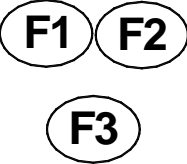
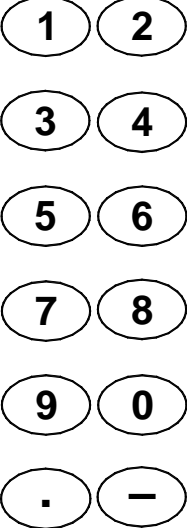
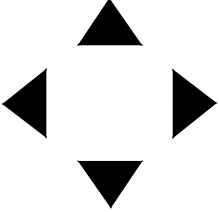







Figure 1-3: CTF878 Keypad

Using the Keypad (cont.)

Table 1-2: CTF878 Key Functions

| Key | Function |
|---|--|
|  | Software Function Keys: Press to select the special functions displayed directly above them at the bottom of the screen. |
|  | 12 Numeric Keys: Use to enter numeric data. |
|  | Arrow Keys: Press to scroll through function choices in measurement mode or to scroll through menu choices in programming mode. Press [←] as a backspace key in programming mode. |
|  | Help Key: Use to access on-line help. See the next section for details. |
|  | Escape Key: Press to exit menus or menu options at any time, or cancel a numeric entry. |
|  | Select Key: Use to move between data measurements on the screen. |
|  | Menu Key: Press to access the Main Menu. |
|  | Enter Key: Use to enter a particular menu or to enter selected values into CTF878 memory. |

Entering the Program Menu

To enter the Program Menu, press the [MENU] key at the lower right of the CTF878 keypad. The Menu Bar replaces the Status Bar at the top of the screen. Press the [▶] arrow key once to scroll from the Site Menu to the Program Menu. At the Program Menu, press [ENTER]. The screen appears similar to Figure 1-4 below. While following the programming instructions, see the *Program Menu Map*, Figure 1-34 on page 1-37.

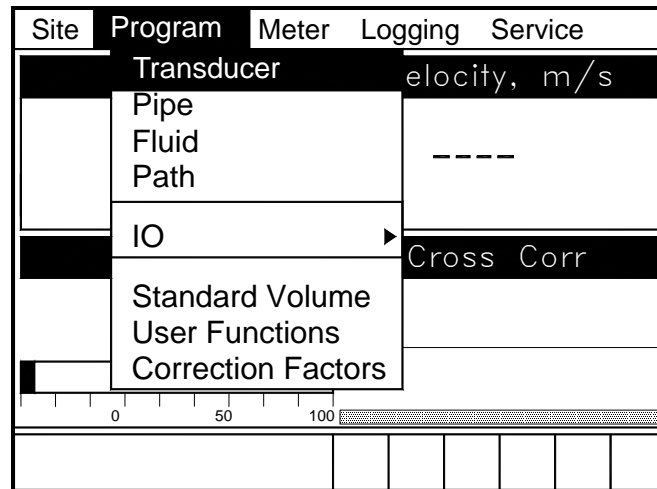

Figure 1-4: Program Menu

To scroll to a particular option, press the [▼] or [▲] arrow keys until you reach the option. Then press [ENTER] to open the option window.

When entering parameters in an option, press:

- The [▼] key to step through the available parameters
- The [▲] key to scroll back to a previously entered parameter
- The [F2] key (Cancel) or the [ESC] key to exit an option at any time and return to Operate Mode without changing the parameters.

Note: *The Transducer, Pipe, Fluid and Path parameters are categorized under the same Transducer/Pipe menu, as shown in Figure 1-5 below. You can be more time-efficient by programming the parameters in all four entries under Transducer/Pipe before exiting the menu.*

When you are highlighting a parameter in one of the four entries, and you wish to go to another entry:

1. Use the [▲] key to scroll up to the current tab (the entry that you are under).
2. Press the [◀] or [▶] key to select the parameter you want to access, then press [ENTER].

Entering Transducer Parameters

To enter the Transducer option, scroll to the Transducer tab on the Program Menu and press [ENTER]. The screen appears similar to Figure 1-5 below. To step through each parameter, press the [▼] key. Refer to the *Program Menu Map*, Figure 1-34 on page 1-37.

Note: *If the CTF878 does not scroll to a particular parameter, the parameter is not necessary for that transducer type.*

Figure 1-5: Transducer Option Window

The next prompt asks you to enter the transducer number (printed on the transducer itself), or to specify that you are using a special application transducer.

1. From the Type prompt, press the [▼] key to reach the Transducer prompt, and press [ENTER].
2. A drop-down list of transducer numbers opens (see Figure 1-6 below). Press the [▼] or [▲] keys to scroll to the appropriate number, or scroll to “Special” for a special application transducer.
3. Press [ENTER] to confirm your selection.

Figure 1-6: Transducer Type Options

Entering Transducer Parameters (cont.)

Upon your selection, a warning screen appears similar to Figure 1-7 below. In three out of four warnings, the Receiver Board option number appears as part of the text.

IMPORTANT: *If SPECIAL is selected as the transducer type, a number does not appear, however, the warning still states that the transducer selection must match the Receiver Board.*

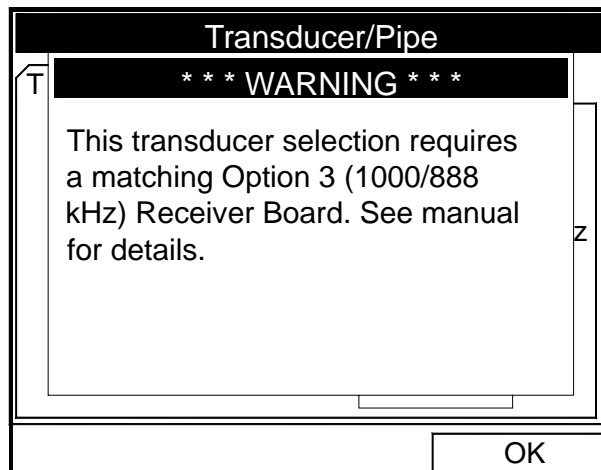

Figure 1-7: Transducer Selection Warning Screen

The Receiver Board option number corresponds to the frequency range selected with the original order (see Table 1-3 below).

Table 1-3: Frequency Options

| Option No. | Frequency Range |
|------------|-------------------|
| 3 | 1 MHz / 888 KHz |
| 4 | 500 KHz / 471 KHz |
| 5 | 250 KHz / 222 KHz |

4. Compare the Receiver Board option number listed on the WARNING screen with the one assigned to your CTF878.

Note: *The Receiver Board option number is the last digit of the CTF878's model number. That model number can be found on the label attached to the inside of the front cover. In Figure 1-8 below the Receiver Board option number is 3.*

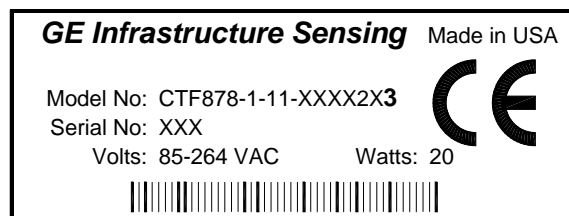

Figure 1-8: Transducer Type Options

Entering Transducer Parameters (cont.)

The program now varies, depending on whether you have selected typical or special transducers.

- If you have selected a typical transducer, the CTF878 comes programmed with the needed parameters. Proceed to *Parameters for Typical Transducers* below.
- However, if your application requires entering a special transducer / receiver option, go to the next section, *Parameters for Special Transducers* on page 1-9.

Parameters for Typical Transducers

If a typical transducer has been selected, the user must:

1. Enter the transducer wedge temperature (Wedge Temp) text box and press [ENTER].
2. Type in the value (provided by the factory) and press [ENTER].
3. Proceed to *Entry Confirmation* on page 1-10.

Parameters for Special Transducers

Note: *The factory will supply the information required below with a special transducer / receiver option.*

The user must enter the appropriate transducer / receiver operating frequency range.

IMPORTANT: *The CTF878 flowmeter and the transducers have the same fixed frequency band of operation defined by the customer's application. The frequency printed on the transducers represents a frequency band of operation and does not always match the up or down frequencies.*

1. From the Transducer prompt, press the [▼] key to reach the Frequency Up (Frq Up) prompt, and press [ENTER].
2. A drop-down list of thirty-six frequencies opens, ranging from 0.222 to 8.00 MHz. Scroll to the correct frequency, and press [ENTER].
3. Repeat the same selection process for the Frequency Down (Frq Dn) prompt.

Next, you must enter the transducer wedge angle (Wedge Ang) and wedge soundspeed (Wedge SS).

4. Scroll to the appropriate text box and press [ENTER].
5. Type in the value (provided by the factory).

Note: *If you enter an incorrect numeric value, press the [◀] key to erase the last digit entered.*

6. Once the value has been entered, press [ENTER] and proceed to *Entry Confirmation* below.

Entry Confirmation

- To confirm the entries and return to Operate mode, press [F3] (OK).
- To leave the window without confirming the entries, press [F2] (Cancel) or the [ESC] key.

In either case, the CTF878 returns to Operate Mode.

Entering Pipe Parameters

To enter the Pipe option, scroll to the Pipe tab on the Program Menu and press [ENTER]. (From the Transducer window, you can scroll back up to the Transducer tab and press the [▶] arrow key to reach the Pipe window, and press [ENTER].) The screen appears similar to Figure 1-9 below. To step through each parameter, press the [▼] key. See the Program Menu Map, Figure 1-34 on page 1-37.

Note: Refer to the installation reference Sound Speeds and Pipe Size Data (914-004) for additional information about pipe sizes and sound speeds.

| Transducer/Pipe | | | |
|-----------------|-----------|------------------------------|------|
| Transducer | Pipe | Fluid | Path |
| Material | Other | | |
| Sound Speed | 600 | m/s | |
| OD, mm | ODxPI, mm | Wall, mm | |
| 5 | 15.71 | 2 | |
| Nominal | Schedule | <input type="checkbox"/> DIN | |
| | | | |
| | | Cancel | OK |

Figure 1-9: Pipe Option Window

Entering Pipe Parameters (cont.)

1. The first prompt asks you to select the pipe material.
 - a. Press [ENTER] to enter the material prompt.
 - b. A drop-down list of materials opens as shown in Figure 1-10 below. Press the [▼] or [▲] keys to scroll to the appropriate material, or scroll to “Other” for a material not on the list. Press the [▶] key to scroll down by a page, or the [◀] key to scroll up by a page.
 - c. Press [ENTER] to confirm the choice.

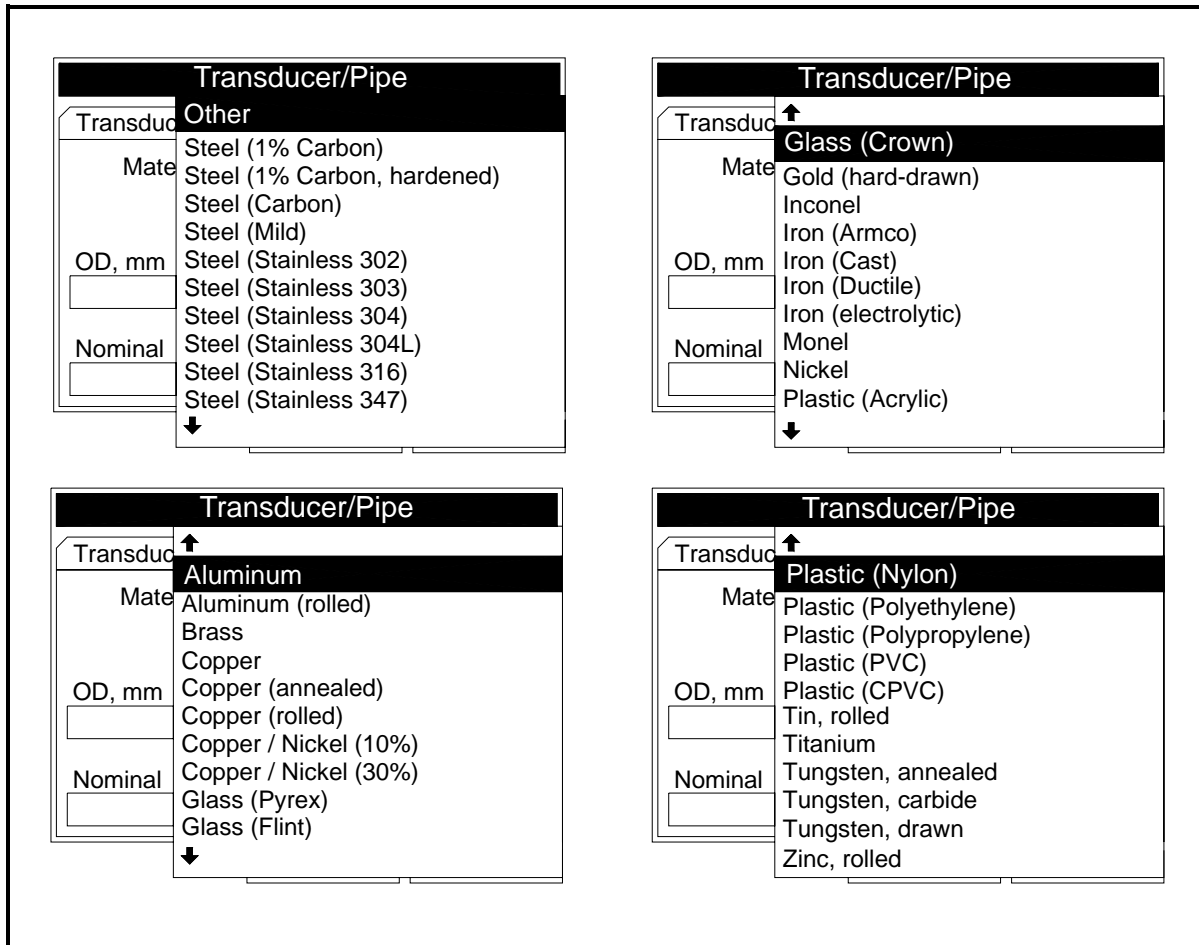

Figure 1-10: Pipe Material Options

Entering Pipe Parameters (cont.)

The screenshot shows a dialog box titled "Transducer/Pipe". It has four tabs: "Transducer", "Pipe", "Fluid", and "Path". The "Pipe" tab is selected. The dialog contains the following fields and controls:

- Material: A text box containing "Other".
- Sound Speed: A text box containing "600" followed by "m/s".
- OD, mm: A text box containing "5".
- ODxPI, mm: A text box containing "15.71".
- Wall, mm: A text box containing "2".
- Nominal: A text box.
- Schedule: A text box.
- DIN: A checkbox.
- Buttons: "English", "Cancel", and "OK" at the bottom.

Figure 1-11: Pipe Option Window

2. For pipe diameter, two alternatives are available. The meter asks for the pipe outside diameter (OD) and wall thickness (Wall). But if you have selected certain pipe materials (carbon or stainless steel, cast iron, PVC and CPVC), you have the option of entering the pipe dimensions by a standardized schedule. Once you enter the nominal pipe size (Nominal) and identification (Schedule), the CTF878 determines the OD and wall thickness from an internal table.

If you want to use the diameter alternative (available for all materials):

- a. You must select from two choices, outside diameter or circumference.
 - *The prompt moves to the outside diameter (OD) text box. Type the OD (in mm or in., whichever is displayed) into the box, and press [ENTER] to confirm your choice,*
 - or
 - *Move the prompt to the circumference (ODxPI) text box. Type the circumference (in mm or in., whichever is displayed) into the text box, and press [ENTER] to confirm the choice.*
- b. In either case, the next prompt asks for the wall thickness. Type the value (in mm or in., whichever is displayed) into the box, and press [ENTER] to confirm your choice.

Note: *The measurement units shown depend on the choices made in the English/Metric window or the Meter Settings menu. You can, however, change the measurement units in any text box by moving to that box and pressing the F1 key.*

Entering Pipe Parameters (cont.)

If you select a material that has the Schedule option, and you wish to use that alternative:

- a. The prompt asks if you wish to apply ANSI (the ANSI schedule). Press [ENTER] to select (or deselect) the ANSI box.

Note: *Selecting the ANSI box enables you to use the Schedule alternative*

- b. Press the [◀] key twice to move the prompt to the Nominal pipe size drop-down menu. Press [ENTER] to open the menu. Scroll to the desired pipe size, and press [ENTER] to confirm your choice.
 - c. Press the [▶] key to move the prompt to the Schedule drop-down menu. Press [ENTER] to open the menu. Scroll to the desired schedule, and press [ENTER] to confirm the choice.
- To confirm the entries and return to Operate Mode, press [F3] (OK).
 - To leave the window without confirming the entries, press [F2] (Cancel) or the [ESC] key.

In either case, the CTF878 returns to Operate Mode.

Entering Fluid Types and Speeds

To access the Fluid option, scroll to the Fluid entry on the Program Menu and press [ENTER]. (If you are already in the Transducer/Pipe form, press the [▶] arrow key to reach the Fluid window, and press [ENTER].) The screen appears similar to Figure 1-12 below. To step through each parameter, press the [▼] key. Refer to the *Program Menu Map*, Figure 1-34 on page 1-37.

The figure consists of two screenshots of the 'Transducer/Pipe' menu. The top screenshot shows the 'Fluid' field set to 'Other', 'Sound Speed' at 600 m/s, and 'K/V x 10⁻⁶' at 14.607 m²/s. The bottom screenshot shows the 'Fluid' field set to 'Other' with a drop-down menu open, listing 'Other', 'Air', and 'Natural Gas'.

Figure 1-12: Fluid Type Options

To select the fluid:

1. Press [ENTER] to open the drop-down menu.
2. Use the [▼] key to scroll to the appropriate option.
3. Press [ENTER] to confirm your selection.

Note: *If you select Air or Natural Gas, the meter sets the soundspeed and suggests a value for $K/V \times 10^{-6}$. If you wish, you can change the value of $K/V \times 10^{-6}$.*

If you select Other, you must enter values for Sound Speed and for $K/V \times 10^{-6}$ (see Installation Reference #914-004, Sound Speeds and Pipe Size Data).

Entering Fluid Types and Speeds (cont.)

- To confirm the entries and return to Operate Mode, press [F3] (OK). The CTF878 returns to Operate Mode.
- To leave the window without confirming the entries, press [F2] (Cancel) or the [ESC] key. The CTF878 returns to Operate Mode.

Entering Path Parameters

To enter the Path option, scroll to the Path tab on the Program Menu and press [ENTER]. (From the Fluid window, you can scroll back up to the Fluid tab, and press [ENTER].) The screen appears similar to Figure 1-13 below. To step through each parameter, press the [▼] key. Refer to *Program Menu Map*, Figure 1-34 on page 1-37.

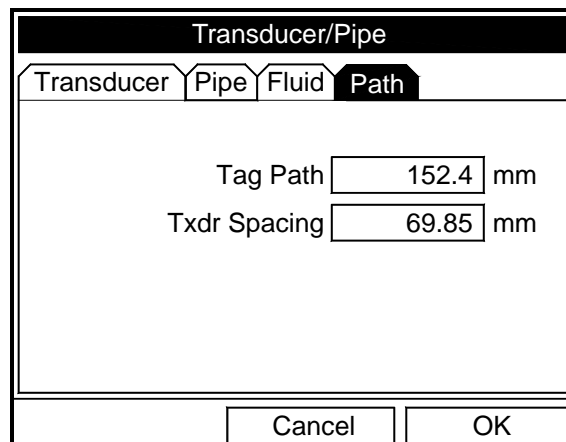

The screenshot shows a window titled "Transducer/Pipe" with four tabs: "Transducer", "Pipe", "Fluid", and "Path". The "Path" tab is selected. Inside the window, there are two input fields: "Tag Path" with the value "152.4 mm" and "Txdr Spacing" with the value "69.85 mm". At the bottom of the window, there are two buttons: "Cancel" and "OK".

Figure 1-13: Path Window

Path Parameters for Clamp-On Transducers

The CTF878 path menu includes two parameters:

- *TAG Path*
- *Transducer Spacing*

The *TAG Path* is calculated from the data entered in the Pipe parameters under Program. It can be overwritten if the user wants to use a value other than the one calculated by the flowmeter. However, it must always match the *TAG Path* set on the clamping fixture for reliable operation. If the path is changed on the instrument and on the clamping fixture, it must be within $\pm 10\%$ of the original *TAG Path* calculated by the flowmeter.

The *Transducer Spacing* is calculated from the data entered in the Transducer/Pipe/Fluid parameters. The value of *Transducer Spacing* is NOT used in the flowmeter's data processing, unlike the Tag Path. Do not attempt to change the *Transducer Spacing* in the instrument. It is only an output intended to tell the user the distance to be set between a Transmitter and a Receiver for optimal signal transmission.

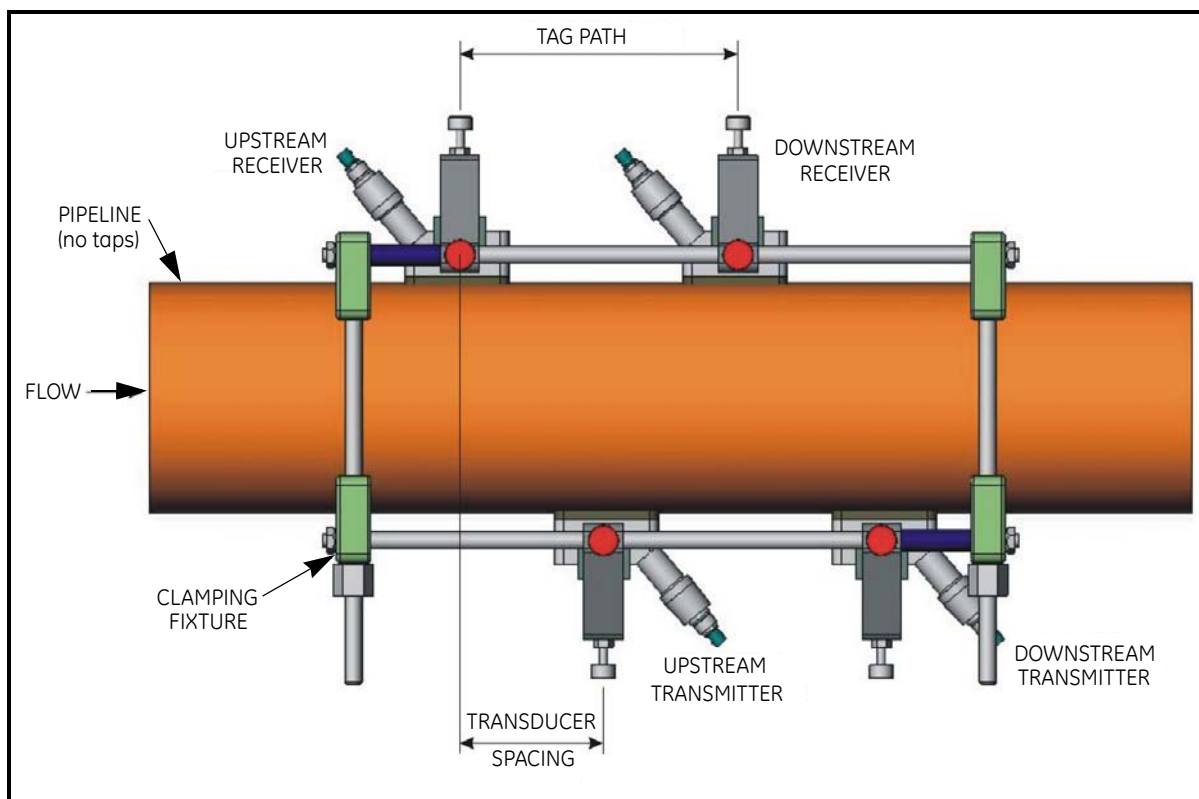

Figure 1-14: Typical Clamping Fixture/Transducer Setup

Entering Analog Inputs

The Analog Input option enables you to specify parameters for general purpose inputs. To enter the Inputs option, scroll to the Input/Output (IO) entry on the Program Menu and press [ENTER]. The screen appears similar to Figure 1-15 below. To step through each parameter, press the [▼] key. Refer to the *Program Menu Map*, Figure 1-36 on page 1-39.

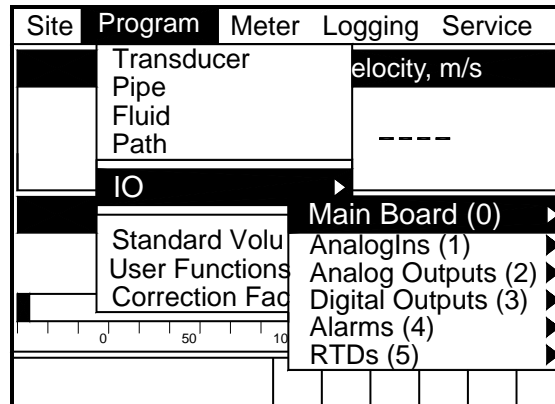

Figure 1-15: Input/Output Option Window

Note: *Input/Output Menu options may appear in a different order, depending on where each option card is installed. Cards are numbered from right to left. The number shown in parentheses is the option card slot number.*

1. Scroll to AnalogIns and press [ENTER] to confirm your selection. Another drop-down menu as in Figure 1-16 below appears.

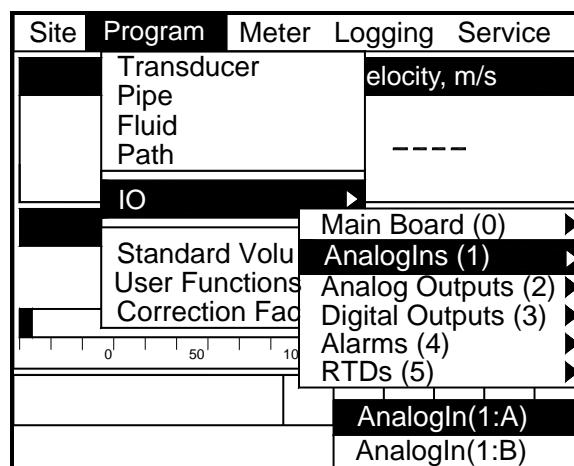
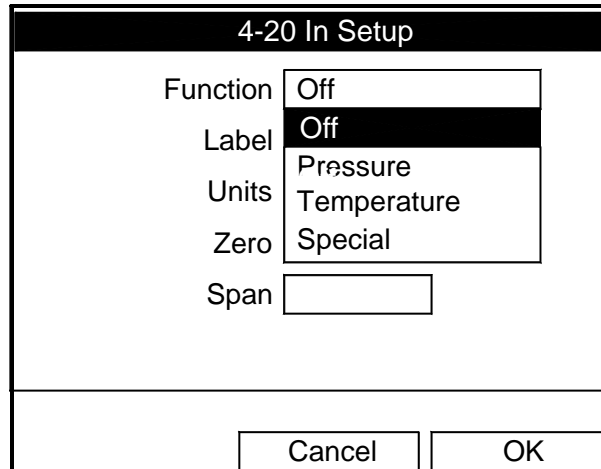

Figure 1-16: Analog Inputs Option Window

Entering Analog Inputs (cont.)

- Use the [▼] key and [ENTER] to select an AnalogIn. At the next prompt, name the input Function by selecting one of four options: Off, Pressure, Temperature or Special (see Figure 1-17 below).

Note: *The units for pressure and temperature are based on the settings in the Meter/Units menu.*



The screenshot shows a menu titled "4-20 In Setup". It contains several fields: "Function" with a dropdown menu open showing "Off", "Label" with "Off" selected, "Units" with "Pressure", "Temperature", and "Special" options, and "Zero" with "Special" selected. There is also a "Span" field with an empty input box. At the bottom right, there are "Cancel" and "OK" buttons.

Figure 1-17: Function Menu Options

- The next prompt asks you to create a name for a special function, if desired (see Figure 1-18 below).

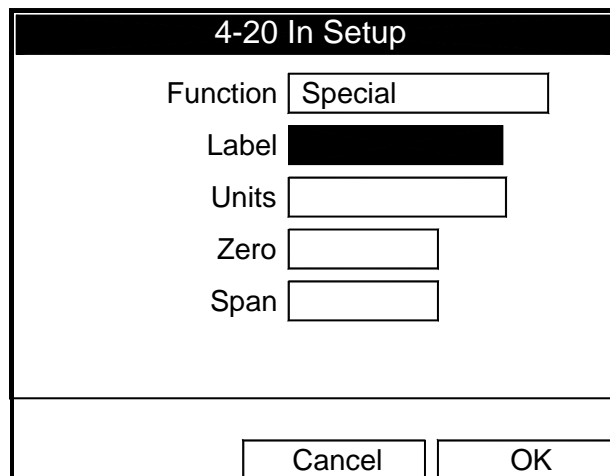

The screenshot shows the same "4-20 In Setup" menu. The "Function" field now contains "Special". The "Label" field is a solid black box. The "Units", "Zero", and "Span" fields are empty input boxes. The "Cancel" and "OK" buttons are still present at the bottom right.

Figure 1-18: Analog Input Information

Entering Analog Inputs (cont.)

- a. Press [ENTER] to enter the text box. The text creation window appears, as shown in Figure 1-19 below.

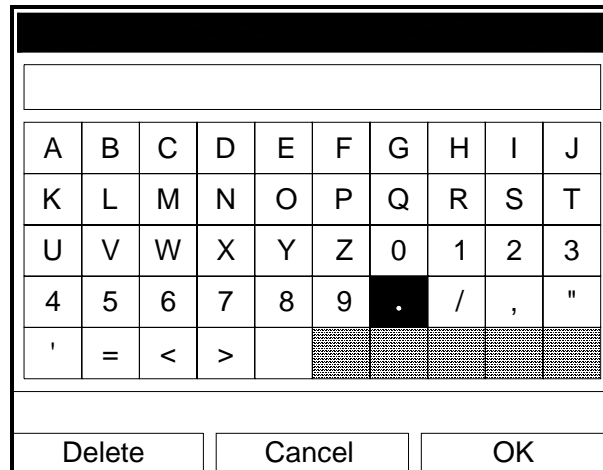

Figure 1-19: Text Creation Window

- b. Use the four arrow keys to scroll to the desired letter or symbol, and press [ENTER] to add the letter to the name.
- Note:** *Pressing [SEL] causes the screen to show successively a set of upper-case (capital) letters, a set of lower-case letters, and a set of symbols. Use all three screens to create a desired label.*
- c. Repeat this procedure for each letter or symbol you wish to add to the name (up to a total of eight characters). If you wish to delete a letter, press [F1] (Delete) to erase each letter or symbol, from right to left on the label.
 - d. When you have completed the label, press [F3] (OK) to confirm the label, or [F2] (Cancel) to leave the window without adding the label.
4. The next three prompts ask for the function units, the zero input value, and the span input value. For each prompt:
 - a. Press [ENTER] to enter the text box.
 - b. Use the numeric keys to enter the desired value.
 - c. Press [ENTER] to confirm the entry.

You have completed entering data for general-purpose inputs.

- To confirm the entries and return to Operate Mode, press [F3] (OK). The CTF878 returns to Operate Mode.
- To leave the window without confirming the entries, press [F2] (Cancel) or the [ESC] key. The CTF878 returns to Operate Mode.

Entering Analog Outputs

The Analog Output option enables the set up of additional output parameters. To enter the option, scroll to the Analog Output entry on the Program Menu (see Figure 1-20 below) and press [ENTER].

Note: *Input/Output Menu options may appear in a different order, depending on where each option card is installed. Cards are numbered from right to left.*

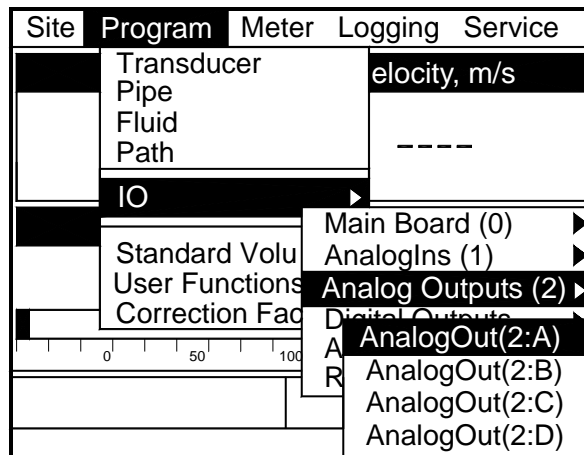

Figure 1-20: Analog Output Option Window

The screen appears similar to Figure 1-21 below. To step through each parameter, press the [▼] key. See the *Program Menu Map*, Figure 1-35 on page 1-38.

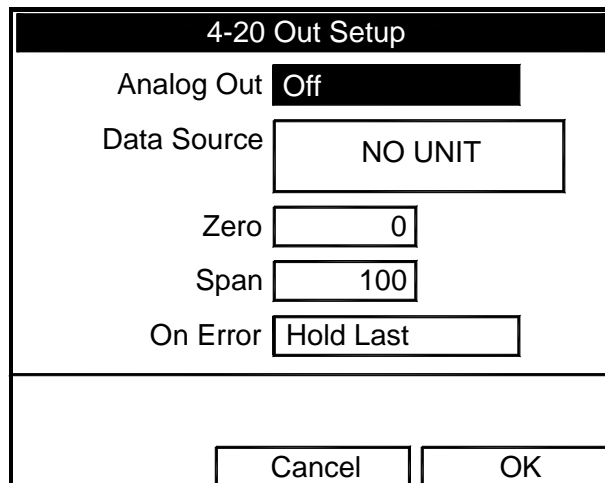

Figure 1-21: Analog Output Window

Entering Analog Outputs (cont.)

1. The first prompt enables you to select a range to send a current signal to a recording device (see Figure 1-22 below).
 - a. Press [ENTER] to open the drop-down menu.
 - b. Scroll to the desired output from three choices: Off, 0-20 mA, and 4-20 mA.
 - c. Press [ENTER] to confirm your selection.

Note: *If you select “Off,” you will not be able to access any other parameters in this option.*

| 4-20 Out Setup | |
|---|-----------|
| Analog Out | Off |
| Data Source | Off |
| Zero | 4ma-20ma |
| Span | 100 |
| On Error | Hold Last |
| <input type="button" value="Cancel"/> <input type="button" value="OK"/> | |

Figure 1-22: Analog Out Selection Window

2. Scroll to the next prompt and select the Data Source measurement type from a list of choices (see Figure 1-23 on page 1-22).
 - a. Press [ENTER] to open the window.
 - b. Scroll to the desired output type.
 - c. Press [SEL] to confirm your selection.
 - d. The prompt then moves to a list of unit types. (The available units depend on the selection made at the Data Source prompt.) Scroll to the desired output unit.
 - e. Press [F3] (OK) to confirm your selection.
3. The next prompt requests the zero (base) value for the analog output. This value represents the 0/4 mA output (in flow units).
 - a. Press [ENTER] to open the text box.
 - b. Use the numeric keys to enter the desired value.
 - c. Press [ENTER] to confirm your selection.

Entering Analog Outputs (cont.)

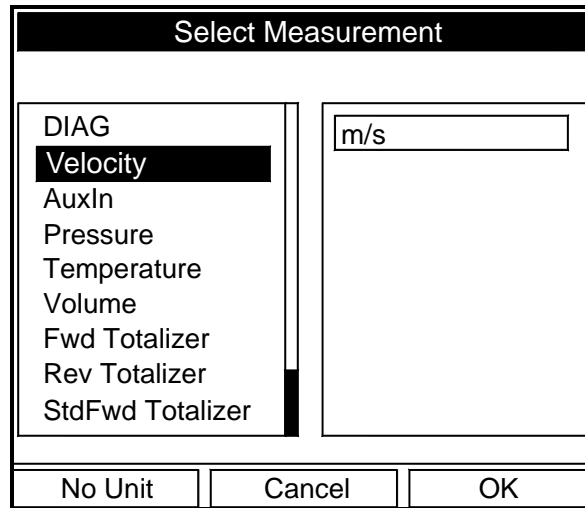

Figure 1-23: Data Source Selection Window

4. The next prompt requests the span (full scale) value for the analog output. This value represents the 20 mA output (in flow units).
 - a. Press [ENTER] to open the text box.
 - b. Use the numeric keys to enter the desired value.
 - c. Press [ENTER] to confirm your selection.
5. The last prompt, On Error, asks you to select how the CTF878 will handle the analog outputs in the event of a fault condition. The meter offers three alternatives:
 - *Hold Last Value (hold the last good reading)*
 - *Force Low (force the reading to 0 or 4 mA)*
 - *Force High (force the reading to 20 mA).*
 - a. Press [ENTER] to open the drop-down menu.
 - b. Scroll to the desired selection.
 - c. Press [ENTER] to confirm your selection.

You have completed entering data in the Analog Output option.

- To confirm the entries and return to Operate mode, press [F3] (OK). The CTF878 returns to Operate Mode.
- To leave the window without confirming the entries, press [F2] (Cancel) or the [ESC] key. The CTF878 returns to Operate Mode.

Entering Digital Outputs

While resembling the Analog Output option, the Digital Output option enables you to set up parameters necessary for a digital output. To enter the option, scroll to the Digital Output entry on the Program / IO / Freq/Tot Menu and press [ENTER].

Note: *Input/Output Menu options may appear in a different order, depending on where each option card is installed. Cards are numbered from right to left.*

The screen appears similar to Figure 1-24 below. To step through each parameter, press the [▼] key. Refer to the *Program Menu Map*, Figure 1-36 on page 1-39.

| Digital Output | |
|---|-------------------------------------|
| Function | Pulse Totalizer |
| Data Source | Fwd Totalizer Fwd m ³ |
| Units/Pulse | 1 m ³ |
| Pulse Width | 10 μs |
| <input type="button" value="Cancel"/> <input type="button" value="OK"/> | |

Figure 1-24: Digital Output Window

1. The first prompt enables you to select the output function from three choices: Off, Pulse Totalizer, Frequency
 - a. Press [ENTER] to open the drop-down menu.
 - b. Scroll to the desired function.
 - c. Press [ENTER] to confirm your selection.

Note: *If you select Off, you will not be able to access any other parameters in this option.*

**Entering Digital Outputs
(cont.)**

2. The next prompt asks you to select the data source for the digital output. The choices vary with the function. For Pulse Totalizer (see Figure 1-24 on page 1-23), the available choices include:
 - *Forward Totalizer*
 - *Reverse Totalizer*
 - *Standard Forward Totalizer*
 - *Standard Reverse Totalizer*
 - a. Press [ENTER] to open the data source selection window.
 - b. Scroll to the desired source.
 - c. Press [SEL] to confirm your selection.
 - d. The prompt then moves to a list of unit types. (The available units depend on the selection made at the Data Source prompt.) Scroll to the desired output unit.
 - e. Press [F3] (OK) to confirm your selection.
3. The last set of parameters that appears depends on the selection you made at the Function prompt.

If you selected Pulse Totalizer:

The prompt asks for the units/pulse and the pulse width (in microseconds). (Figure 1-24 on page 1-23 illustrates a Digital Output window configured for the Pulse Totalizer function.) For the Units/Pulse and Pulse Width parameters:

- a. Press [ENTER] to open the text box.
- b. Use the numeric keys to enter the desired value.
- c. Press [ENTER] to confirm your selection.

If you selected Frequency:

The prompt asks for the minimum and maximum value for the category and units selected and the minimum and maximum frequency. For each parameter:

- a. Press [ENTER] to open the text box.
- b. Use the numeric keys to enter the desired value.
- c. Press [ENTER] to confirm your selection.

Entering Alarm Parameters

The Alarms option enables you to enter parameters necessary to set up alarms. To enter the option, scroll to the Alarms entry on the Program / IO Menu and press [ENTER].

Note: *Input/Output Menu options may appear in a different order, depending on where each option card is installed. Cards are numbered from right to left.*

The screen appears similar to Figure 1-25 below. To step through each parameter, press the [▼] key. Refer to the *Program Menu Map*, Figure 1-36 on page 1-39.

| Alarm Setup | |
|----------------|-----------------------------------|
| Function | Low |
| | Velocity m/s |
| | <input type="checkbox"/> Failsafe |
| Trigger Point | 2500 |
| Cancel OK | |

Figure 1-25: Alarm Setup Window

1. The first prompt enables you to select the function from four choices: Disabled, High, Low, and All Faults.
 - a. Press [ENTER] to open the drop-down menu.
 - b. Scroll to the desired function.
 - c. Press [ENTER] to confirm your selection.

Entering Alarm Parameters (cont.)

2. Scroll to the next prompt and select the Data Source measurement type from a list of choices (see Figure 1-26 below).
 - a. Press [ENTER] to open the window.
 - b. Scroll to the desired output type.
 - c. Press [SEL] to confirm your selection.
 - d. The prompt then moves to a list of unit types. (The available units depend on the selection made at the Data Source prompt.) Scroll to the desired output unit.
 - e. Press [F3] (OK) to confirm your selection.

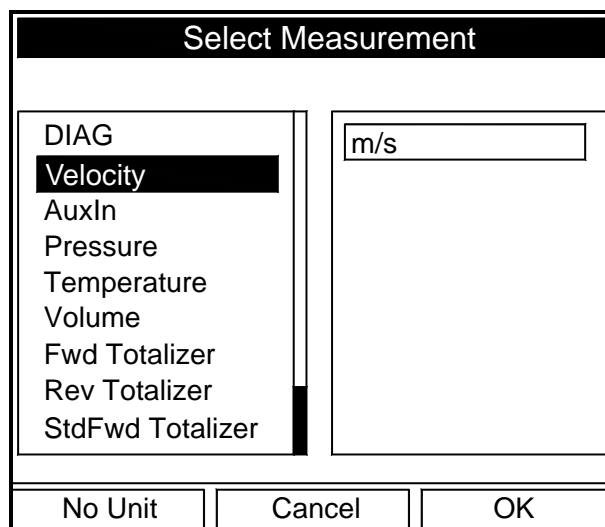

Figure 1-26: Data Source Selection Window

3. Scroll to the next prompt and press [ENTER] to select or deselect the Failsafe option. If Failsafe is selected, an **X** will appear in the box.
4. The next prompt asks for the Trigger Point frequency:
 - a. Press [ENTER] to open the text box.
 - b. Use the numeric keys to enter the desired value.
 - c. Press [ENTER] to confirm your selection.

Entering Standard Volume Data

The Standard Volume option enables you to set base measurements and specific values for pressure and temperature inputs and to select the corresponding option cards. To enter this option, scroll to Standard Volume on the Program Menu and press [ENTER].

Entering Settings

The screen appears similar to Figure 1-27 below. To step through each parameter, press the [▼] key. Refer to the *Program Menu Map*, Figure 1-34 on page 1-37.

Figure 1-27: Standard Volume Window - Settings

1. The first prompt allows you to enable or disable the Standard Volume settings.
 - a. Use the arrow keys to move to the appropriate choice.
 - b. Press [ENTER] to confirm your choice.

Note: *If you selected Enabled, continue on to step 2 to enter values for the three categories. If you selected Disabled, you will not be able to access the three boxes or the Inputs entry.*

2. To enter numbers for the three categories:
 - a. Press the [▼] key to move from one box to the next.
 - b. Press [ENTER] and use the number keys to enter a value for each category.
 - c. Press [ENTER] to confirm each entry.

Entering Inputs

Note: *You can access the Inputs entry only if you selected Enabled for Standard Volume under the Settings tab.*

Use the arrow keys to move to the Inputs tab and press [ENTER] to confirm your selection. The screen appears similar to Figure 1-28 below. Use the [▼] key to move from one line to the next. Refer to the *Program Menu Map*, Figure 1-34 on page 1-37.

Figure 1-28: Standard Volume Window - Inputs

1. The first prompt allows you to fix the Pressure value or to render it active.
 - a. Use the arrow keys to move to the appropriate choice.
 - b. Press [ENTER] to confirm your choice.

Note: *If you selected Fixed, continue on to step 2 to enter a value for the pressure. If you selected Active, you will not be able to enter the Pressure box and must proceed to step 3.*

2. To enter a value for the pressure:
 - a. Press the [▼] key to move to the Pressure box.
 - b. Press [ENTER] and use the number keys to enter a value for the pressure.
 - c. Press [ENTER] to confirm your entry.

Entering Inputs (cont.)

3. To designate an option card number:
 - a. Use the arrow keys to move to the Input # box.
 - b. Press [ENTER] to open a scroll-down menu.
 - c. Use the key to scroll to the appropriate value and press [ENTER] to select the appropriate option card number.
4. The next prompt allows you to fix the Temperature value or to render it active.
 - a. Use the arrow keys to move to the appropriate choice.
 - b. Press [ENTER] to confirm your choice.

Note: *If you selected Fixed, continue on to step 5 to enter a value for the temperature. If you selected Active, you will not be able to enter the Temp box and must proceed to step 6.*

5. To enter a value for the temperature:
 - a. Press the [▼] key to move to the Temp box.
 - b. Press [ENTER] and use the number keys to enter a value for the temperature.
 - c. Press [ENTER] to confirm your entry.
6. To designate an option card number:
 - a. Use the arrow keys to move to the Input # box.
 - b. Press [ENTER] to open a scroll-down menu.
 - c. Use the key to scroll to the appropriate value and press [ENTER] to select the appropriate option card number.

Entering User Functions

User functions enable you to program mathematical equations on each measurement. You can also use any parameter in the meter to calculate a different parameter. To enter the User Functions option, scroll to the User Functions entry on the Program Menu and press [ENTER]. The screen appears similar to Figure 1-29 below. To step through each parameter, press the [▼] key. Refer to the *Program Menu Map*, Figure 1-34 on page 1-37.

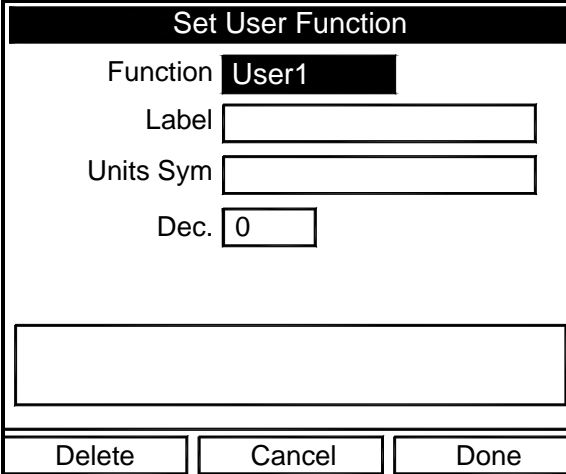

| Set User Function | | |
|-------------------|--------|------|
| Function | User1 | |
| Label | | |
| Units Sym | | |
| Dec. | 0 | |
| | | |
| Delete | Cancel | Done |

Figure 1-29: User Function Window

1. The first prompt requests the function number, 1 through 8.
 - a. Press [ENTER] to open the drop-down menu.
 - b. Scroll to the desired function number (User1, User2, etc.).
 - c. Press [ENTER] to confirm the entry.
2. The next prompt asks you to create a label for the function.

Note: *The label corresponds to the measurement type (i.e., velocity or temperature), the units symbol corresponds to the measurement units (i.e., feet/sec or degrees F), and the Dec. option elects the number of decimal places.*

Entering User Functions (cont.)

- a. Press [ENTER] to open the text creation window, which appears similar to Figure 1-30 below.

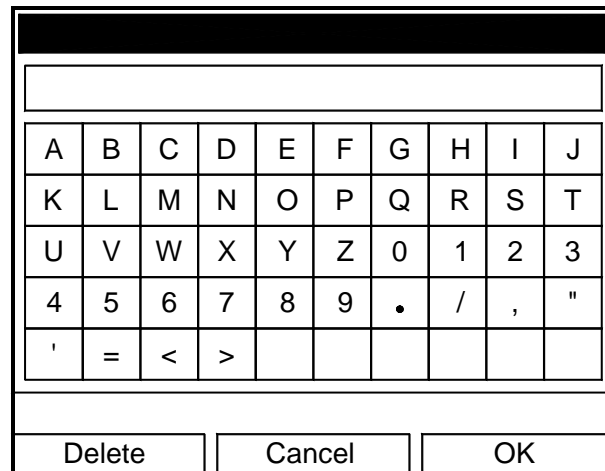

Figure 1-30: Text Creation Window

- b. Use the four arrow keys to scroll to the desired letter or symbol, and press [ENTER] to add the letter to the label.
- Note:** *Pressing [SEL] causes the screen to alternate between upper-case (capital) letters, lower-case letters, and symbols. You may use any or all of the three screens to create a label.*
- c. Repeat this procedure for each letter or symbol you wish to add to the label. If you wish to delete a letter, press [F1] (Delete) to erase each letter or symbol, from right to left on the label.
 - d. When you have completed the label, press [F3] (OK) to confirm the label, or [F2] (Cancel) to leave the window without adding the label.
3. The next prompt asks for the Units Symbol.
 - a. Press [ENTER] to reopen the text creation window.
 - b. Repeat the procedure used for the Label (above) to create the Units Symbol.
 - c. When you have completed the entry, press [F3] (OK) to confirm the symbol, or [F2] (Cancel) to leave the window without adding the symbol.
 4. The next prompt asks you to select the number of decimal places.
 - a. Press [ENTER] to open the drop-down menu.
 - b. Scroll to the desired number of decimal places, ranging 0 to 4.
 - c. Press [ENTER] to confirm the entry.

Entering User Functions (cont.)

5. The final prompt asks for the function itself.
 - a. Press [ENTER] to open the function creation window, which appears similar to Figure 1-31 below.
 - b. Use the four arrow keys to scroll to the desired function or table, and press [ENTER] to confirm each entry. Use the numeric keys to enter numeric values. Press [F1] (Delete) to remove any mistaken or unwanted symbols or numbers.

Note: Pressing [SEL] causes the screen to alternate between a set of symbols and functions and a list of user functions. Use both screens to create the desired function.

| | | | | | |
|--------|------|--------|------|------|------|
| | | | | | |
| | | | | | |
| - | + | * | / | (|) |
| ^ | E | abs | exp | inv | ln |
| log | sqrt | MODE | | | |
| sin | cos | tan | asin | acos | atan |
| tblA | tblB | tblC | tblD | tblE | tblF |
| | | | | | |
| Delete | | Cancel | | OK | |

Figure 1-31: Function Creation Window

- c. To enter a particular measured parameter into the equation, click on the MODE symbol near the middle of the third row. The Select Measurement window (shown in Figure 1-23 on page 1-22) opens. Select the desired data source and unit (see page 1-23), and press [F3] (OK) to confirm the entry.
 - d. When you have completed entering the function, press [F3] (OK) to confirm the entry and return to the User Function window.
6. GE Sensing recommends pressing [F2] (Check) to test the validity of the function. The CTF878 displays either “OK” or a message such as “Syntax Error.”
 - Press [F1] to delete the entire function, or
 - Press [F3] (Done) to confirm the function and return to Operate Mode.

Entering a Calibration Factor

The final option in the Program Menu, Correction Factor, allows you to enter and modify the Calibration Factor. To enter the Correction Factors option, scroll to the Correction Factors entry on the Program Menu and press [ENTER]. The screen appears similar to Figure 1-32 below. To access the Calibration Factor, press the [▼] key. Refer to the *Program Menu Map*, Figure 1-34 on page 1-37.

Figure 1-32: Calibration Factor Window

1. To enable or disable the Calibration Factor, scroll down to the next line and select On or Off.
 - a. Use the [◀] and [▶] keys to scroll to the appropriate option.
 - b. Press [ENTER] to confirm your selection.
2. If On is selected for the Calibration Factor, scroll down to choose a Single K-Factor or a Table of K-Factors.
 - a. Use the [◀] and [▶] keys to scroll to the appropriate radio button.
 - b. Press [ENTER] to confirm your selection.

Entering a Calibration Factor (cont.)

If you selected Single:

This feature enables a single multiplier to be applied to the flow rate reported by the CTF878.

1. Scroll down to the Meter K-Factor box.
2. Press [ENTER] to open the text box.
3. Use the numeric keys to enter the desired value. The typical factor is between 0.5 and 2.00.
4. Press [ENTER] to confirm your selection.

You have completed entering data for a single Calibration Factor.

- To confirm the entries and return to Operate mode, press [F3] (OK). The CTF878 returns to Operate Mode.
- To leave the window without confirming the entries, press [F2] (Cancel) or the [ESC] key. The CTF878 returns to Operate Mode.

If you selected Table:

The menu asks, first for the data source, and then for the entry of values into the Correction Factor table. This feature allows the user to “curve fit” velocity calibration multiple data points (from several different data sources or flow variables) to the flow rate reported by the CTF878.

Note: *You must select the desired measurement and unit before you can enter the data table in Edit Table.*

1. Scroll down to the Data Source box.
2. Press [ENTER] to open the Data Source window. The Select Measurement window (Figure 1-23 on page 1-22) appears.
3. Enter the desired measurement and units as described on page 1-22.
4. Press [F3] (OK) to confirm your selection.
5. Scroll down to Edit Table.

Entering a Calibration Factor (cont.)

6. Press [ENTER] to open the table (similar to Figure 1-33 below).

| Edit KFactor Table | | |
|--------------------|-------------|----------------|
| | | 0 |
| | Data Source | KFactor |
| 1 | | |
| 2 | | |
| 3 | | |
| 4 | | |
| 5 | | |
| | | Cancel OK |

Figure 1-33: KFactor Table

7. Use the four arrow keys to move to the desired entry in the table.
8. Use the numeric keys to enter the desired value for the data source, and press [ENTER] to confirm the entry.
9. Press the [▶] key to move to the KFactor column. Use the numeric keys to enter the desired value, and press [ENTER] to confirm the entry.
10. Repeat steps 7, 8 and 9 for the remainder of the table.
11. When you have completed entering values, press [F3] (OK) to confirm the table and return to the Correction Factors window.

You have completed entering data for correction factors.

- To confirm the entries and return to Operate mode, press [F3] (OK). The CTF878 returns to Operate Mode.
- To leave the window without confirming the entries, press [F2] (Cancel) or the [ESC] key. The CTF878 returns to Operate Mode.

To aid in following the programming instructions, a complete menu map of the *User Program* is included in Figure 1-34 on page 1-37, Figure 1-35 on page 1-38 and Figure 1-36 on page 1-39.

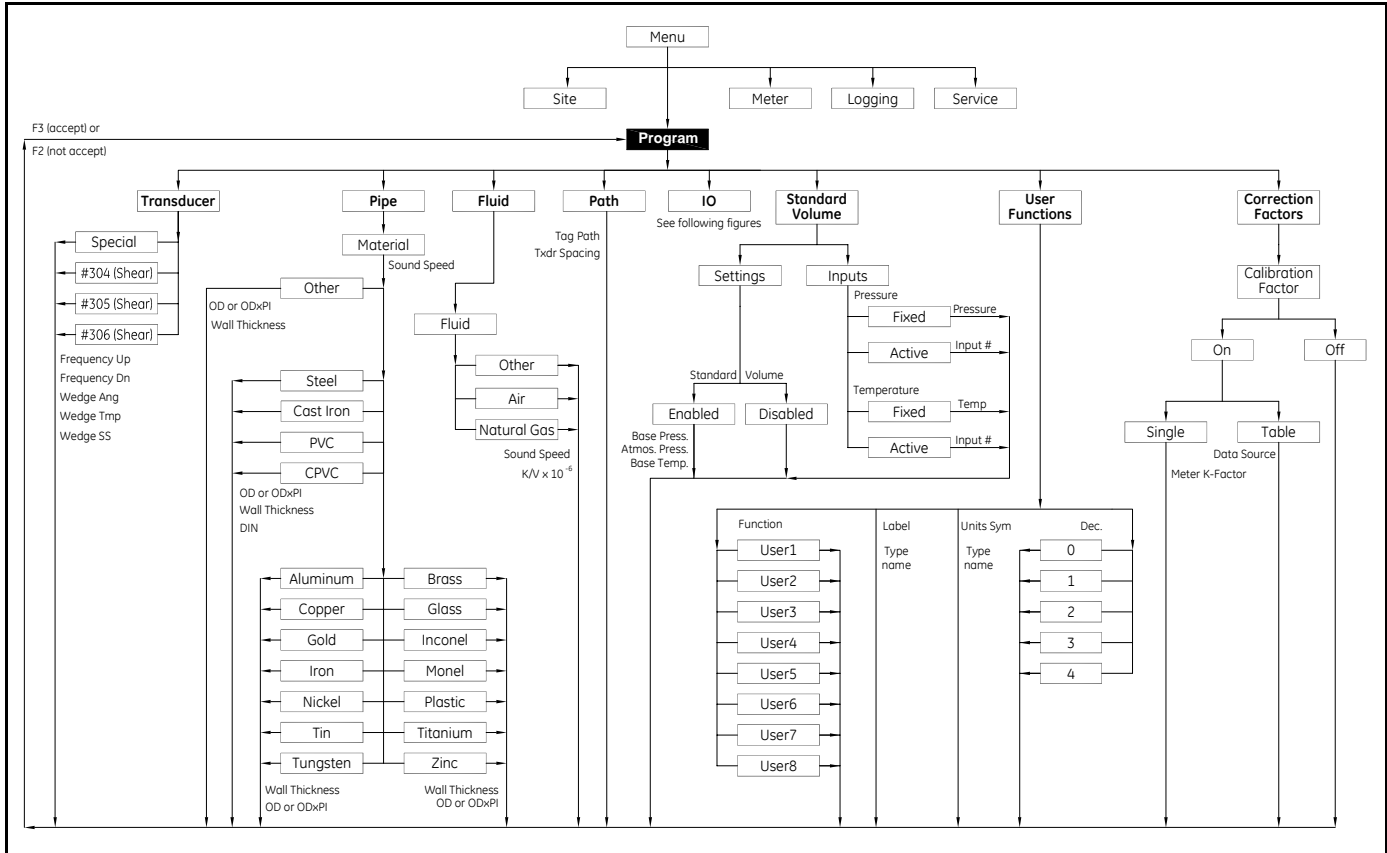

Figure 1-34: Program Menu Map - Initial Setup

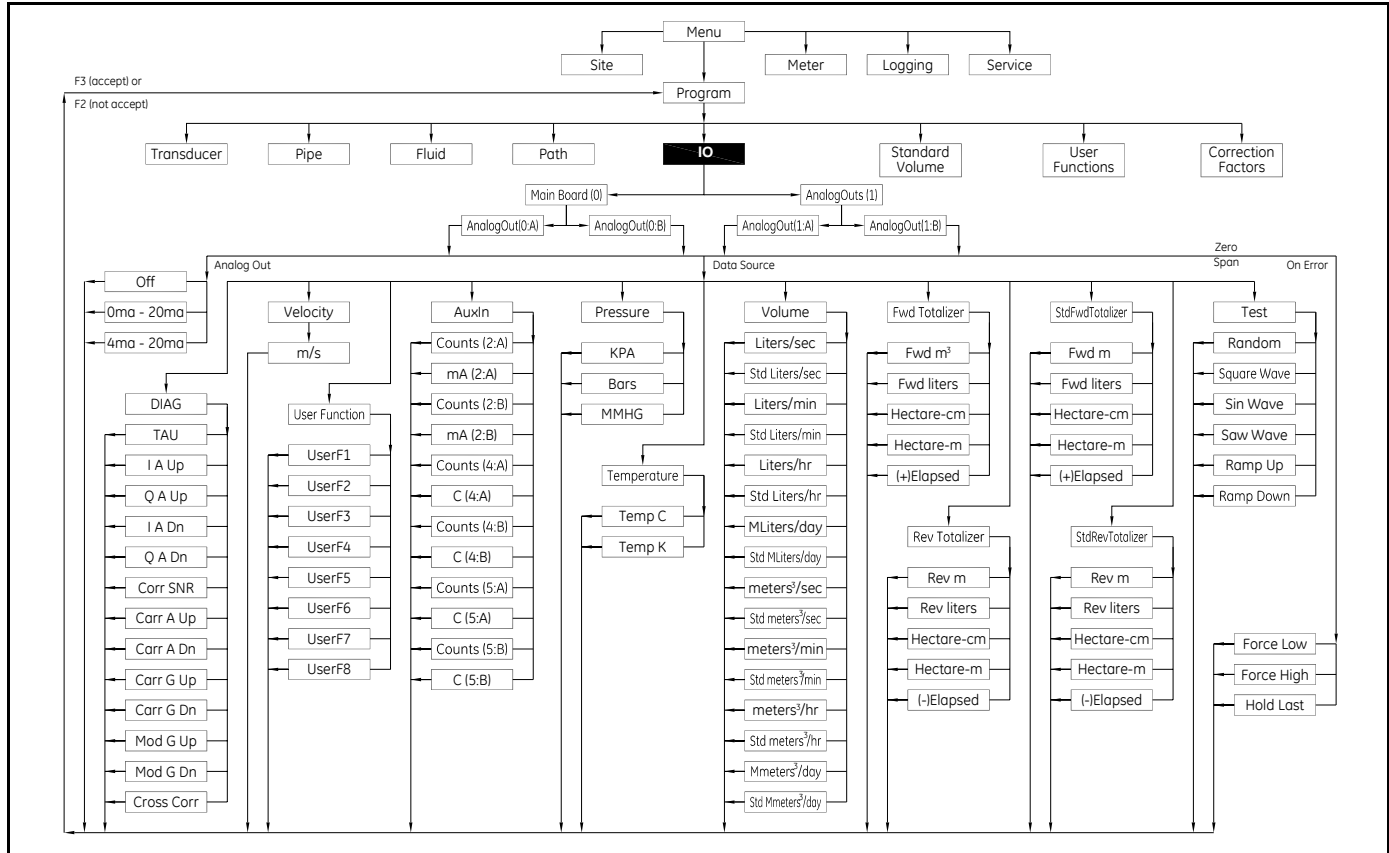

Figure 1-35: Input/Output Menu Map - Initial Setup for Analog Outputs

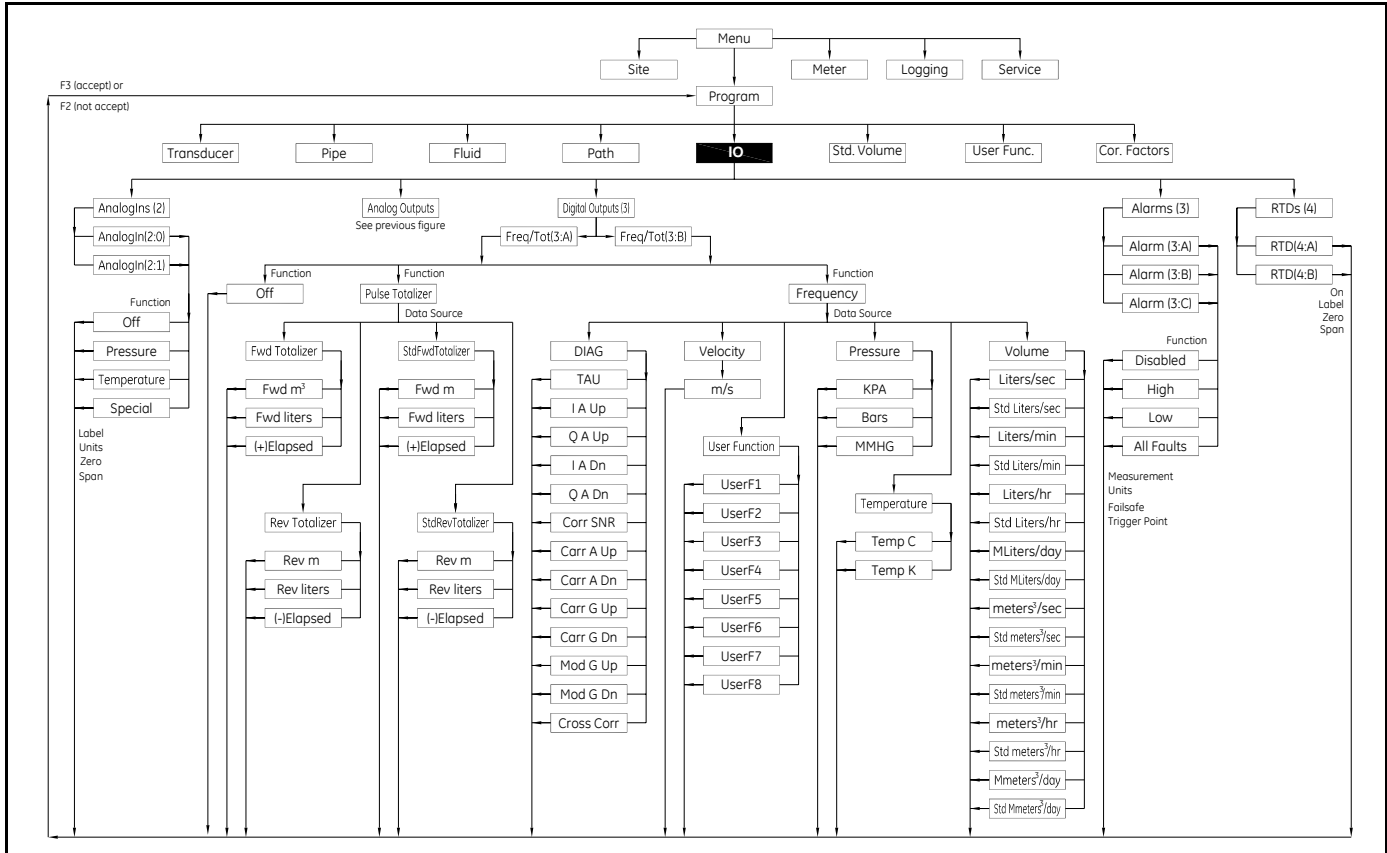

Figure 1-36: Input/Output Menu Map - Initial Setup for Analog Inputs, Digital Outputs, Alarms and RTDs

Chapter 2

Displaying and Configuring Data

- Introduction..... 2-1
- Format Option..... 2-2
- View Option..... 2-3
- Limits Option..... 2-3
- Measurement Option..... 2-5
- Customizing the Display Screen..... 2-6
- Accessing Meter Data —The About Option..... 2-10

Introduction

The CTF878 enables the viewing of from one to four different measurement parameters simultaneously. The screen can show these parameters not only in numeric format, but as line or bar graphs as well.

You can configure any given measurement for your particular requirements. To configure an individual measurement, press [SEL] from the Operate Mode window. A cursor appears next to the parameter closest to the upper left corner. Continuing to press [SEL] enables the cursor to scroll through the other displayed measurements. Once you have reached a particular window, pressing the [ENTER] button opens the menu for that window, as shown in Figure 2-1 below. To learn how to use the display window menu, go to *Format Option* on page 2-2, *View Option* on page 2-3, and/or *Limits Option* on page 2-3.

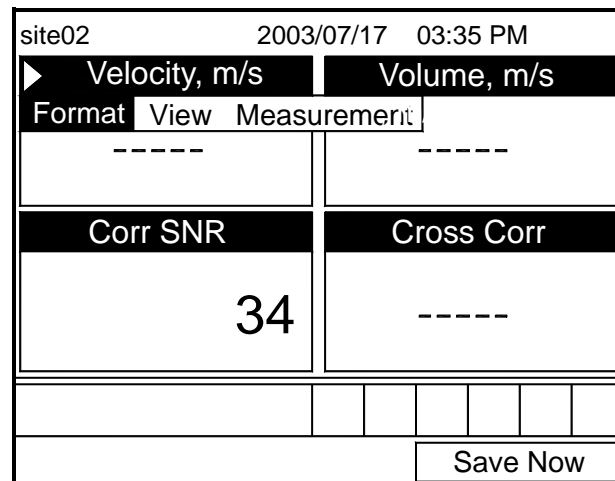

Figure 2-1: Display Screen After Pressing [SEL]

Format Option

Format, the first option on the menu, allows you to specify the type of notation and the number of decimal places for the measurement in that window. Press [ENTER] and the submenu shows two options: Format and Decimal Places. Press the [▼] or [▲] arrow keys to select either entry, and press [ENTER]. The screen appears similar to Figure 2-2 below. To scroll to a particular parameter or menu entry, press the [▼] or [▲] key.

Note: *If the window displays a line or bar graph, the Measurement option appears instead of Format in the menu.*

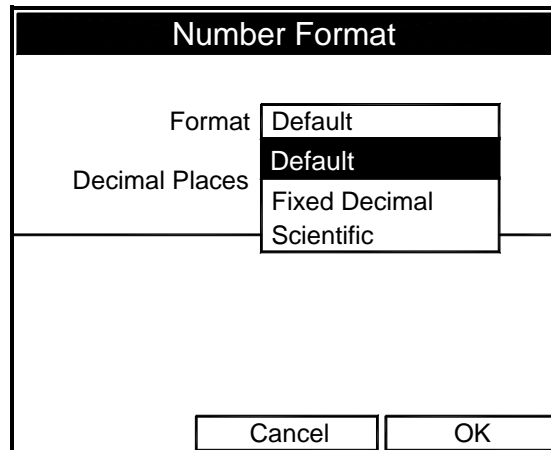

Figure 2-2: Number Format Window

1. The first entry, Format, asks you to select the numeric format from three choices: default, fixed decimal and scientific. Default provides the default resolution, while Fixed Decimal allows users to override the standard resolution. Scientific format displays the value in mantissa and exponent format.
 - a. Press [ENTER] to open the drop-down list of format choices.
 - b. Scroll to the appropriate selection.
 - c. Press [ENTER] to confirm your choice.
2. The second step asks you to choose the number of decimal places to be displayed. Available choices range from 0 to 4 places.
 - a. Press [ENTER] to open the drop-down list.
 - b. Scroll to the appropriate number.
 - c. Press [ENTER] to confirm your choice.
3. To confirm the entries and return to Operate mode, press [F3] (OK). To leave the window without confirming the entries, press [F2] (Cancel) or the [ESC] key.

View Option

The second option, View, allows you to select the presentation of a parameter in one of three formats: numeric, bar graph or line graph.

1. From the Display Menu, press the [▶] key once to reach the View option, and then press [ENTER].
2. A drop-down menu shows the three formats. Scroll to the appropriate selection.
3. Press [ENTER] to confirm your selection.

The screen immediately displays any changes. For example, if you have changed the first parameter to a line graph, the screen appears similar to Figure 2-3 below.

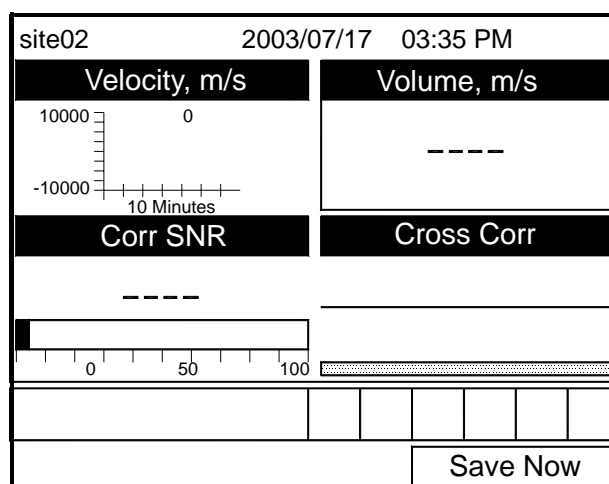

Figure 2-3: Screen After Format Change

Limits Option

Once you have configured a parameter as a line or bar graph, you might need to change its presentation or values. The Limits option (replacing the Format option for line and bar graphs) enables you to program the minimum or maximum values displayed, the time interval and the display of the average value.

To enter the Limits option:

1. Press [SEL] from the Operate Mode window until you have reached the desired measurement.
2. Press [ENTER] to open the Display Menu.
3. Be sure the Limits option is highlighted, and press [ENTER].
4. A drop-down menu entry, Change, appears. Press [ENTER] again.

Limits Option (cont.)

The screen appears similar to Figure 2-4 below.

Figure 2-4: Line (or Bar) Graph Parameters Window

5. The first prompt asks for the minimum value shown in the graph.
 - a. Press [ENTER] to open the text box.
 - b. Use the numeric keys to enter the desired value.
 - c. Press [ENTER] to confirm the value.
6. Repeat the procedure in step 5 to enter the maximum value.

A line graph involves two more prompts.

7. The next prompt asks for the display interval.
 - a. Press [ENTER] to open the text box. Use the numeric keys to enter the desired number. Press [ENTER] to confirm the value.
 - b. The second box asks for the interval in terms of seconds, minutes, hours, or days. Press [ENTER] to open the drop-down menu, and then press the [▼] or [▲] keys to move to the desired parameter. Press [ENTER] to confirm the entry.
8. The final three prompts ask for details of the graph configuration: if you want to use lines, plot the average value, or show the minimum and maximum values. Press the [▼] key to step through each value, and press [ENTER] to add a given detail as part of the graph.
9. When you have configured the graph, press [F3] (OK) to confirm the graph settings, or press [F2] (Cancel) to cancel the changes.

The screen returns to Operate Mode, and displays any changes.

Measurement Option

On occasion, you might need to change the actual parameter measured in a given window. The Measurement option enables you to reconfigure the window with one of several categories of data and appropriate English or metric measurement units.

To enter the Measurement option:

1. Press [SEL] from the Operate Mode window until you have reached the measurement you want to replace.
2. Press [ENTER] to open the Display Menu.
3. Be sure the Measurement option is highlighted, and press [ENTER].

The screen appears similar to Figure 2-5 below. The left column displays categories of data, while the right column displays English and metric measurement units (or, with the Diagnostics source shown, a list of diagnostics parameters).

4. Use the [▼] and [▲] arrow keys to reach the desired category of data, and press [SEL].
5. Then use the [▼] or [▲] arrow keys to select the desired measurement unit (or diagnostic parameter). Press [F3] (OK) to confirm the entry or press [F2] (Cancel) to cancel the changes.
6. The screen returns to Operate Mode, and displays any changes.

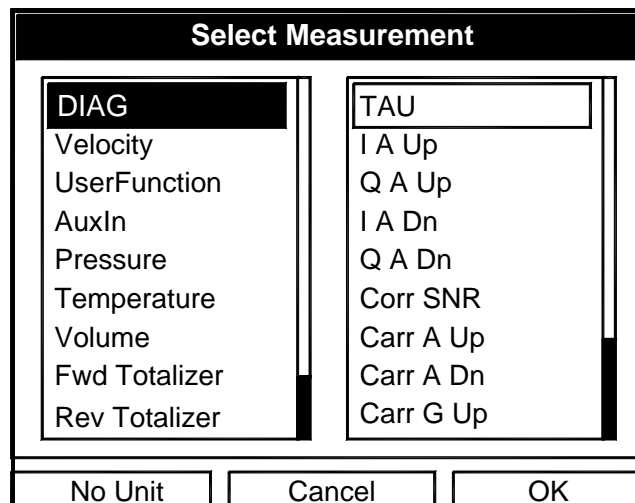

Figure 2-5: Measurement Menu Window

Customizing the Display Screen

You might wish to display one or two parameters, or customize the soft keys to quickly access particular menus. The Site Menu enables you to make more comprehensive changes in your display screen.

To enter the Site Menu, press the [MENU] key at the lower right of the CTF878 keypad. The Menu Bar replaces the Status Bar at the top of the screen. Scroll to the Site Menu using the [◀] or [▶] key. Press [ENTER] or the [▼] arrow key. The screen now appears similar to Figure 2-6 below. While following the programming instructions, refer to Figure 3-13 on page 3-12.

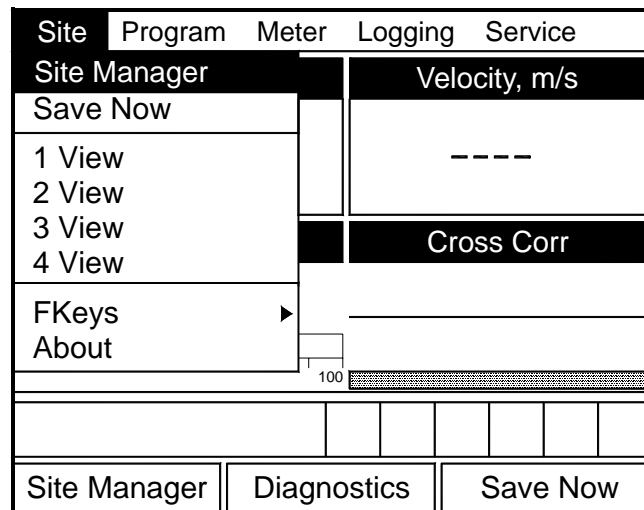

Figure 2-6: Site Menu

- To specify the number of parameters displayed, go to page 2-7.
- To customize or clear softkeys (FKeys), go to page 2-8.

Specifying the Number of Displayed Parameters

As mentioned earlier, the CTF878 can display one to four different measurement parameters simultaneously. However, sometimes you might wish to display only one or two parameters. To change the number of open display windows from within the Site Menu (shown in Figure 2-6 on page 2-6), use the [▼] or [▲] arrow keys to move to the desired number of views (1 View, 2 Views, etc.). Press [ENTER].

The screen displays the designated number of windows. For example, Figure 2-7 below shows the screen displayed in Figure 2-3 on page 2-3, reconfigured for a single view.

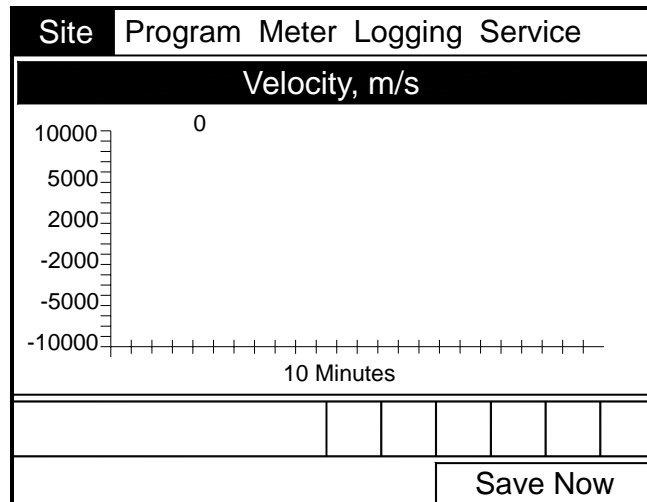

Figure 2-7: Display Screen Configured for Single View

Note: *The CTF878 opens display windows from left to right and from top to bottom, starting from the upper left; that is, if you press “1 View,” the parameter displayed in the upper left window appears. If you press “2 Views,” the parameters shown in the two top windows appear. The view for “3 Views” adds the window in the lower left, and that for “4 Views” adds the window in the lower right.*

Customizing Softkeys

When the screen is in Operate Mode, you might wish to access a particular submenu frequently without the trouble of scrolling through menus. Customizing the softkeys ([F1], [F2] and [F3]) allows you to access up to three submenus by pressing the associated softkey. You can customize a softkey from the Site Menu or from within a particular menu.

- To customize a softkey from within the Site Menu:
 - From the Site Menu (shown in Figure 2-6 on page 2-6), use the [▼] or [▲] arrow keys to move to the FKeys entry on the menu. Press [ENTER]. The screen now appears similar to Figure 2-8 below.

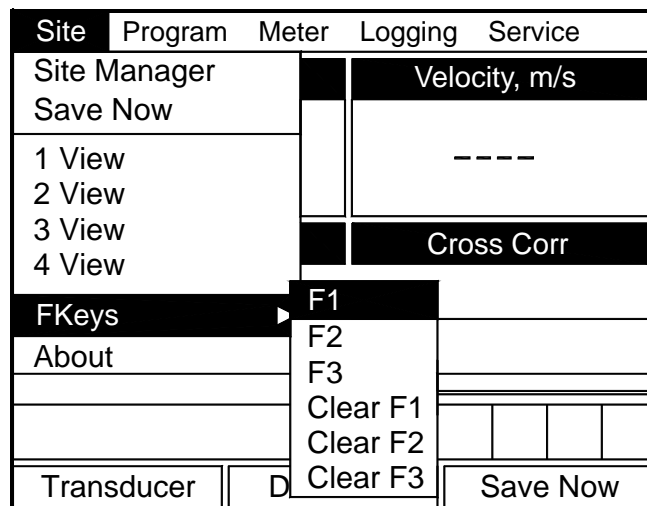

Figure 2-8: FKeys Menu

- Use the [▼] or [▲] arrow keys to move to the desired FKKey (1, 2 or 3) entry on the menu. Press [ENTER]. The Configure FKKey window opens, as shown in Figure 2-9 below.

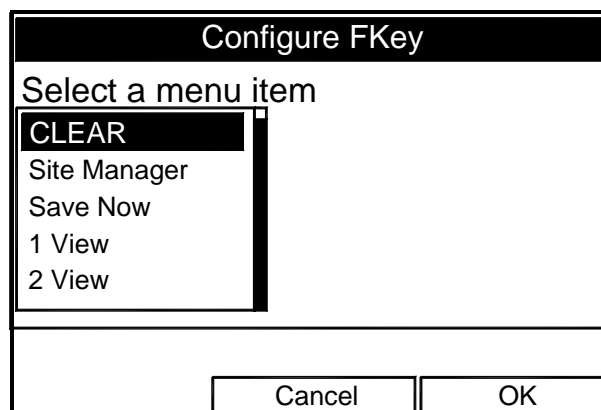

Figure 2-9: Configure FKKey Window

Customizing Softkeys (cont.)

3. Use the [▼] or [▲] arrow keys to scroll to the desired submenu (for example, Site Manager).
4. Press [ENTER] to confirm the entry, and press [F3] (OK) to confirm the entry and close the window. (Press [F2] (Cancel) to close the window without changing the key.)

The screen now appears similar to Figure 2-10 below, with the [F1] window displaying “Site Manager.” Pressing [F1] opens the Site Manager window.

- To customize a softkey from a particular menu:
 1. Open the desired menu on the Menu Bar (see other chapters for details on particular menus) and scroll to the desired option.
 2. Press the desired softkey. A window appears with the question, “Assign current menu command to FKeyX?”
 3. Press [F3] (Yes) to confirm the assignment and close the window. (Press [F2] (No) to close the window without changing the key.)

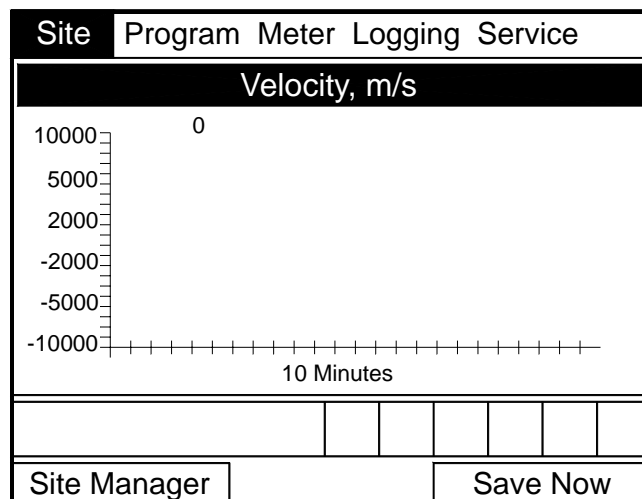

Figure 2-10: Display Screen with Modified Softkey

Customizing Softkeys (cont.)

- To clear a softkey:
 1. From the Site Menu (shown in Figure 2-6 on page 2-6), use the [▼] or [▲] arrow keys to move to the FKeys entry on the menu. Press [ENTER]. The screen now appears similar to Figure 2-8 on page 2-8.
 2. Use the [▼] or [▲] arrow keys to move to the desired Clear FKey (1, 2 or 3) entry on the menu. Press [ENTER].

The softkey window clears. You can also clear the softkey through the Configure FKey window, by selecting (Clear) as an entry, pressing [ENTER] and then [F3] (OK).

Note: *Since the customized softkeys are saved globally, they will remain, even if you change site files.*

Accessing Meter Data — The About Option

The About option displays useful information concerning the model number and software version of any given CTF878. While the window normally appears briefly at startup, users might want to access the information for a longer period. To open the About window, scroll to the About option on the Site Menu and press [ENTER]. The screen appears similar to Figure 2-11 below. To access data on your specific CTF878, press [F2] (Next).

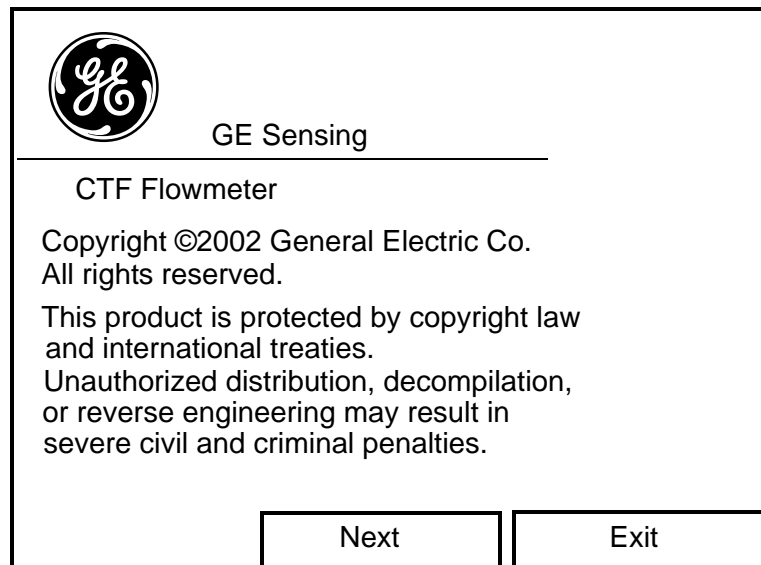

Figure 2-11: The About Window

To return to Operate Mode, press [ESC] or [F3] (Exit).

Chapter 3

Creating and Managing Sites

Introduction..... 3-1

Site Manager..... 3-2

Introduction

As mentioned in Chapter 1, the CTF878 can store site data in files for current and future access. (To learn how to program setup data, refer to Chapter 1, *Programming Site Data*.) After you answer the necessary questions, simply save the information to a site file. The Site Manager option then enables you to recall, rename, revert to or delete site files as needed.

To open the Site Menu, press the [MENU] key at the lower right side of the CTF878 keypad. The Menu Bar replaces the Status Bar at the top of the screen. Scroll to the Site Menu using the [◀] or [▶] key. Then press [ENTER]. The screen now appears similar to Figure 3-1 below. To manage the site files, use the following instructions and refer to Figure 3-13 on page 3-12.

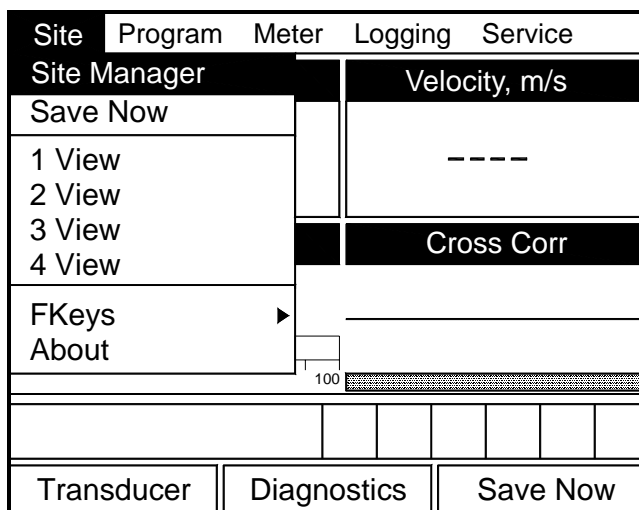

Figure 3-1: Site Menu

Site Manager

To access the Site Manager, press [MENU]. Scroll to the Site Menu using the [◀] or [▶] key. Then press [ENTER]. The drop-down menu appears. At this point, the Site Manager should be highlighted. Press [ENTER] to open the Site Manager window. The screen appears similar to Figure 3-2 below.

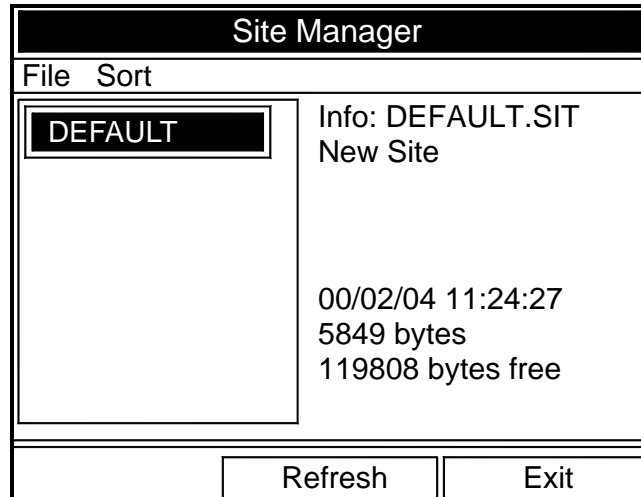

Figure 3-2: Site Manager Window

Note: Each CTF878 comes preprogrammed with a basic site, Default, which serves as a basis for saving data and creating other sites.

The right section of the screen supplies information for the site highlighted in the list on the left: its date, time and size, as well as the remaining amount of free memory. You can use the [▼] and [▲] arrow keys to scroll to a particular site and display information pertaining to that site.

To open the Site Manager menu, press [MENU] and then [ENTER]. The screen now appears similar to Figure 3-3 on page 3-3.

Site Manager (cont.)

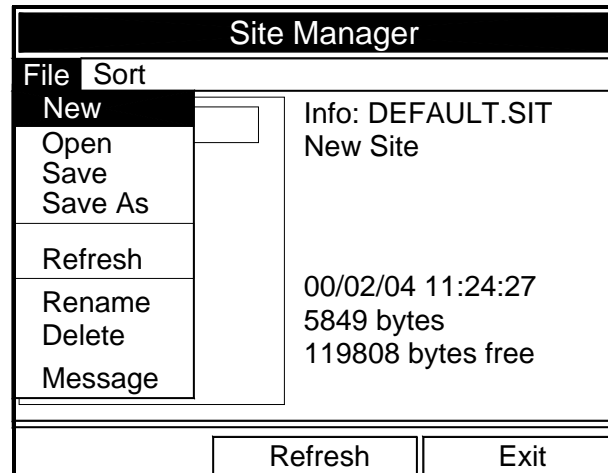

Figure 3-3: Site Manager Menu

Depending on the choice made, proceed to one of the following:

- Creating a New Site on page 3-4
- Opening an Existing Site on page 3-6
- Saving a Site on page 3-7
- Saving a Site with a Different Name on page 3-8
- Refreshing a Site on page 3-8
- Renaming a Site on page 3-9
- Deleting a Site on page 3-10

Arrange files from the Sort submenu (see Figure 3-12 on page 3-11.)

- Listing Files by Name on page 3-11
- Listing Files in Chronological Order on page 3-11

Creating a New Site (cont.) A second screen appears (see Figure 3-5 on page 3-5) asking if you want to use the currently highlighted site as a template, with the current display windows, measurements and programmed data. (To modify the display and measurements, refer to Chapter 2, *Displaying and Configuring Data*. To alter programming data, see Chapter 1, *Programming Site Data*.)

- Press [F2] (No) to reject it, or
- Press [F3] (Yes) to use it as a template.

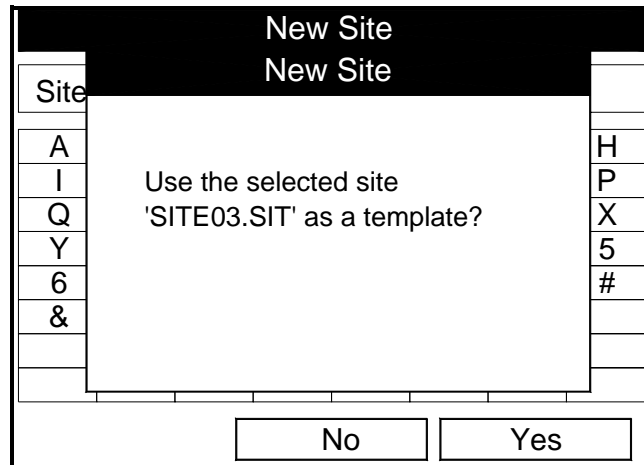

Figure 3-5: Template Confirmation Window

The meter returns to Operate Mode, with the new site name displayed in the upper left corner of the screen.

Opening an Existing Site

If you want to return to a site you have previously saved, first highlight the replacement site in the left window of the Site Manager. Then press [MENU] to open the File Menu. Scroll to the Open option, and press [ENTER]. The screen appears similar to Figure 3-6 below.

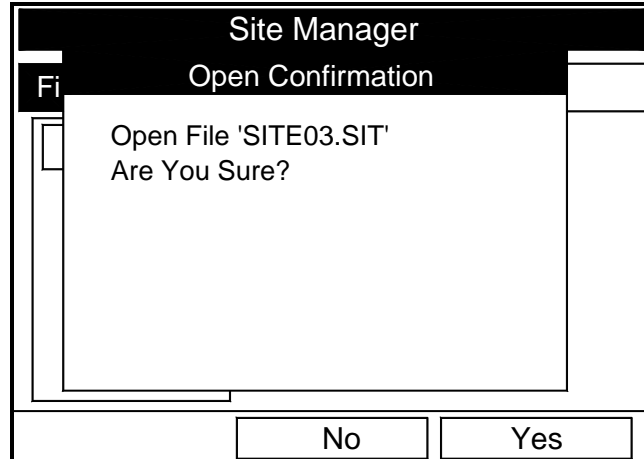

Figure 3-6: Open Site Confirmation Window

- Press [F2] (No) to cancel opening the site and return to the current site, or
- Press [F3] (Yes) to open the site.

If you have changed the current site, the CTF878 asks if you want to save the changes to the previously opened site.

- Press [F2] (No) to cancel the changes, or
- Press [F3] (Yes) to confirm and save the changes.

The CTF878 returns to Operate Mode, with the selected site displayed in the upper left corner of the screen.

Saving a Site

You can save the current site in one of two ways:

- From the Site Menu, you can scroll down to the Save option and press [ENTER], or
- From within the Site Manager, press [MENU] to open the File Menu, scroll to the Save option, and press [ENTER].

In either case, the screen appears similar to Figure 3-7 below.

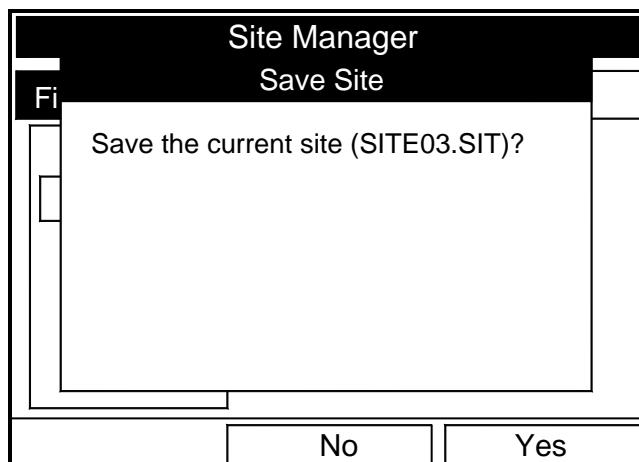

Figure 3-7: Save Current Site Window

- Press [F2] (No) to cancel saving the site, or
- Press [F3] (Yes) to save the site.

The CTF878 remains in the current window (Operate Mode or Site Manager), with the current site saved.

Renaming a Site

If you want to rename a site, first be sure the site has been highlighted in the left window of the Site Manager. Then press [MENU] to enter the File Menu, scroll to the Rename option, and press [ENTER]. The screen appears similar to Figure 3-9 below.

| Rename Site | | | | | | | |
|----------------------------|---|---|---|---|---|---|---|
| SITE03 | | | | | | | |
| A | B | C | D | E | F | G | H |
| I | J | K | L | M | N | O | P |
| Q | R | S | T | U | V | W | X |
| Y | Z | 0 | 1 | 2 | 3 | 4 | 5 |
| 6 | 7 | 8 | 9 | | | | |
| | | | | | | | |
| | | | | | | | |
| | | | | | | | |
| | | | | | | | |
| Delete Cancel OK | | | | | | | |

Figure 3-9: Rename Site Window

Use the four arrow keys to scroll to the desired letter or number, and press [ENTER]. Repeat this procedure until you have created the desired site name. (Press [F1], Delete, to remove any unwanted letters or numbers.) When you have finished,

- Press [F2] (Cancel) to erase the entry, or
- Press [F3] (OK) to confirm the entry.

The CTF878 remains in Site Manager, with the site listed under the new name.

Deleting a Site

To delete a site in the Site Manager, first highlight that site in the left window of the Site Manager. Then press [MENU] to open the File Menu, scroll to the Delete option, and press [ENTER]. You cannot delete the current (open) site. If you try, the following display appears (see Figure 3-10 below). Press [F3] (OK) to return to the File Menu.

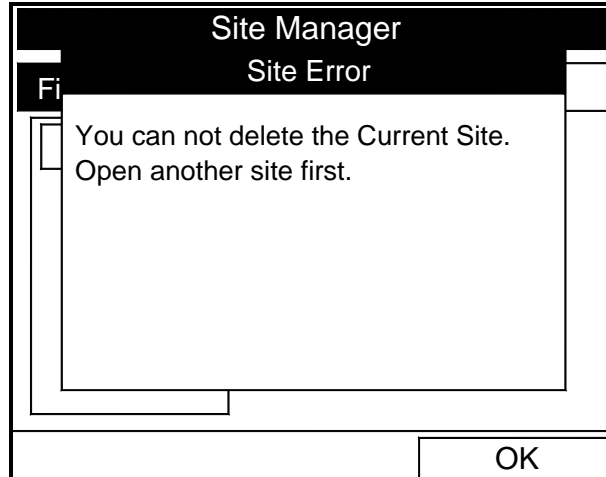

Figure 3-10: Site Error Window

Otherwise, the screen appears similar to Figure 3-11 below.

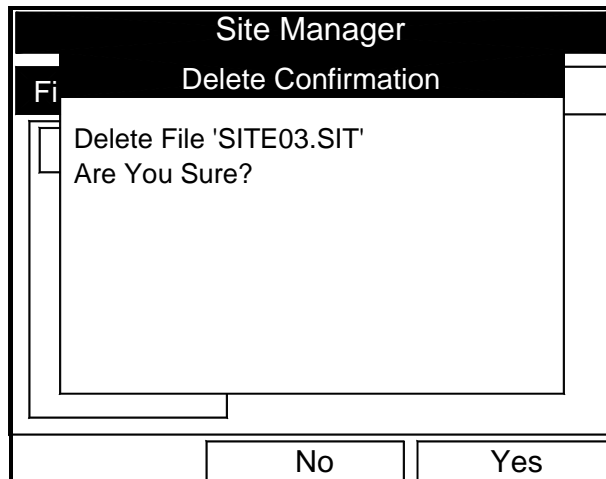

Figure 3-11: Delete Confirmation Window

- Press [F2] (No) to cancel the deletion and return to the Site Manager, or
- Press [F3] (Yes) to delete the site.

The Site Manager appears and deletes the highlighted site.

Listing Files by Name

If you want to list your files alphabetically by site name within the Site Manager, press [MENU] to open the File Menu. Then press the [▶] arrow key to scroll to the Sort Menu (see Figure 3-12 below). Press [ENTER]. The Site Manager screen refreshes, with the sites listed in alphabetical order.

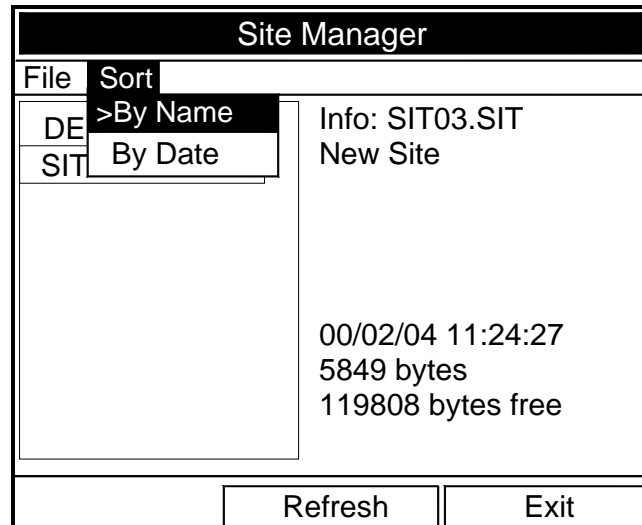
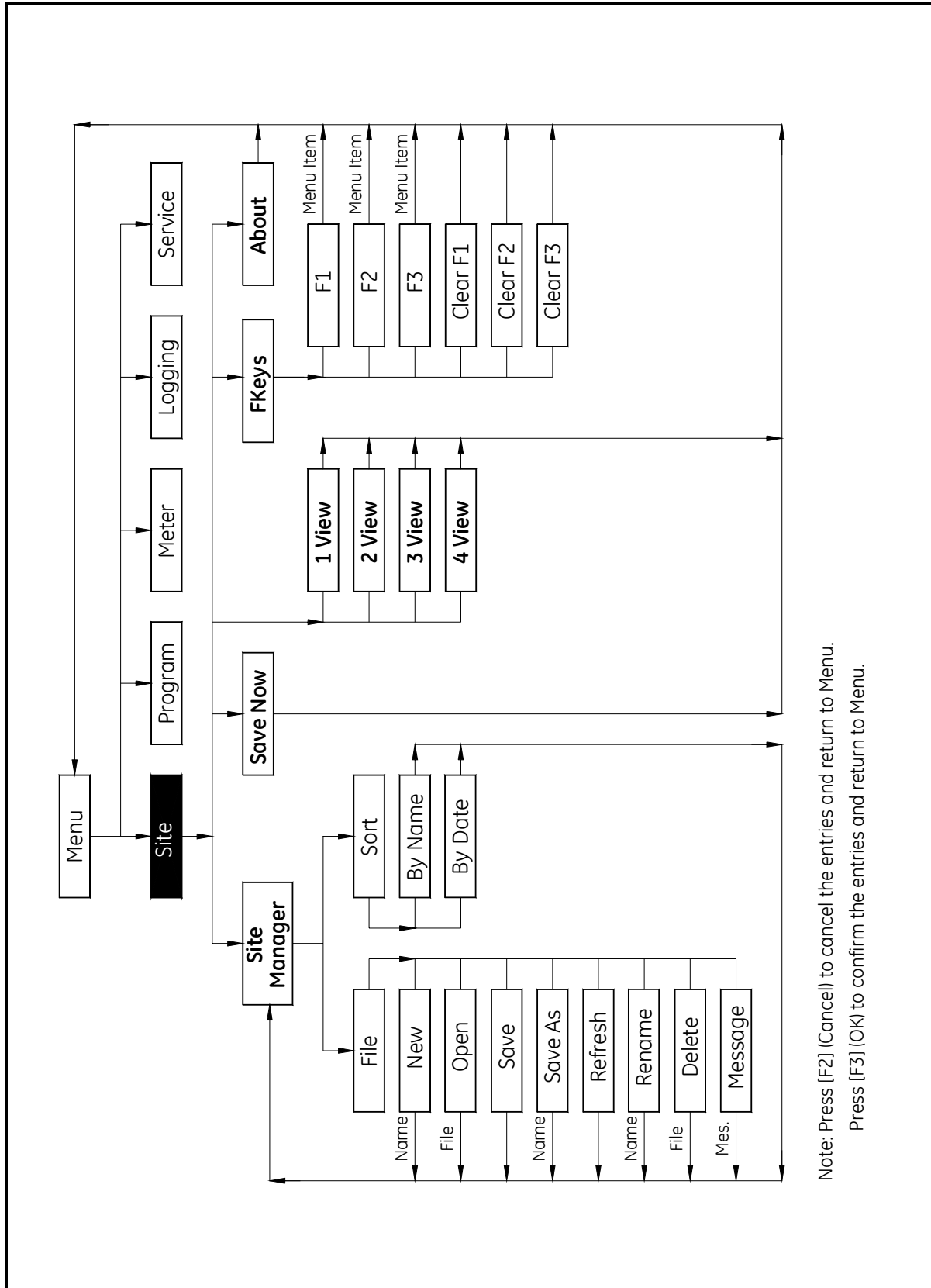

Figure 3-12: Sort Submenu

Listing Files in Chronological Order

To list your files chronologically by time of creation within the Site Manager, press [MENU] to open the File Menu. Press the [▶] arrow key to scroll to the Sort Menu, then scroll to the By Date option. Press [ENTER]. The Site Manager screen refreshes, with the sites listed in chronological order, from the most recent to the earliest.



Note: Press [F2] (Cancel) to cancel the entries and return to Menu.
 Press [F3] (OK) to confirm the entries and return to Menu.

Figure 3-13: Site Menu Map

Chapter 4

Programming Meter Settings

- Introduction..... 4-1
- Entering the Meter Menu 4-1
- Selecting Measurement Units 4-2
- Entering Date and Time 4-3
- Changing Date and Time Appearance 4-4
- Adjusting Contrast..... 4-6
- Setting Backlight Timeout 4-7
- Changing Communications Parameters..... 4-8
- Resetting Forward and Reverse Totals 4-10
- Setting Up User Tables 4-11

Introduction

Along with display formats and site data, CTF878 users can program global settings for the meter that suit their individual preferences. The global settings include:

- English or Metric measurement units
- Date and time parameters and appearance (locale)
- Screen contrast
- Backlight timeout
- Resetting forward and reverse totals
- User tables

Entering the Meter Menu

To enter the Meter Menu, press the [MENU] key at the lower right of the CTF878 keypad. The Main Menu replaces the Status Bar at the top of the screen. Press the [▶] arrow key twice to scroll from the Site Menu to the Meter Menu. At the Meter Menu, press [ENTER]. The screen appears similar to Figure 4-1 below. While programming, refer to the *Meter Menu Map*, Figure 4-10 on page 4-14.

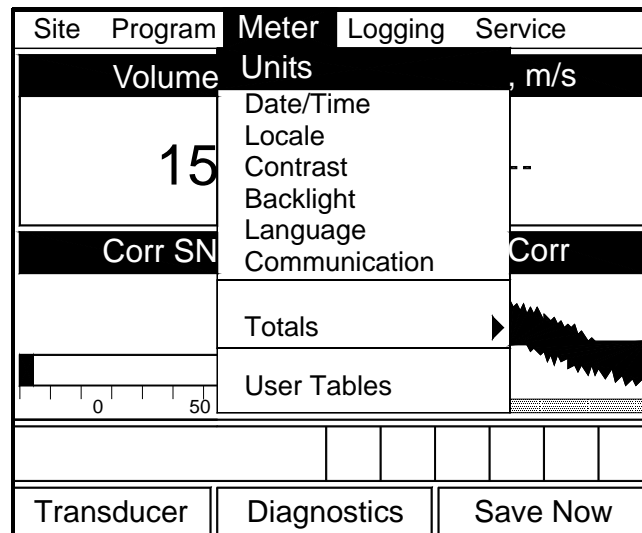

Figure 4-1: Meter Menu

Entering the Meter Menu (cont.)

To scroll to a particular option, press the [▼] or [▲] arrow keys until you reach the option. Then press [ENTER] to open the option window.

When entering parameters in an option, press:

- The [▼] key to step through the available parameters
- The [▲] key to scroll back to a previously entered parameter
- The [F2] key (Cancel) or the [ESC] key to exit an option at any time and return to Operate Mode without changing the parameters.

Selecting Measurement Units

The first option, Units, enables you to select either English or Metric units as global measurement units for the CTF878. The selected units then become the default settings for every measurement that has the option for metric/English units. To select the units, scroll to the Units entry on the Meter menu and press [ENTER]. The Meter Settings window opens, as shown in Figure 4-2 below.

| Meter Settings | |
|-------------------------------|---|
| Units | |
| <input type="radio"/> English | <input checked="" type="radio"/> Metric |
| Date: 2003/08/08 | Pressure Units: MMHG |
| Time: 6:56:17 AM | |
| Cancel OK | |

Figure 4-2: Meter Settings Window

1. Use the [◀] and [▶] keys to scroll between English and Metric units.
2. Press [ENTER] to confirm the choice.

Entering Date and Time

In Operate mode, the Status Bar displays the current date and time above the measurements in the upper right corner of the screen. The Date/Time option allows you to set the date or time, which are required for correct data logging operation.

To set the time:

1. From the Meter menu, scroll to the Date/Time entry and press [ENTER]. The Meter Settings window reopens (see Figure 4-2 on page 4-2).
2. From the Units option, press the [▼] key once to reach the date text box. This box displays the current meter date.
3. Press [ENTER] to enter the text window. The meter highlights the center number. Use the [◀] and [▶] keys to scroll to any number you wish to change.
4. Two alternatives are available to change a highlighted number:
 - Use the numeric keys to enter the desired number.
 - Use the [▼] or [▲] arrow keys to scroll, in 1-digit increments, to the desired number. (For example, if the text box highlights 09, pressing the [▼] key twice changes the number to 07. You can scroll from 01 to 12 for the month and from 01 to 31 for the day (depending on the number you have selected for the month.)

In either case, press [ENTER] to confirm the entry.

To enter or change the time:

1. From the time text box, press the [▼] key once to scroll to the time text box. This box displays the current meter time.
2. Press [ENTER] to enter the text box. The meter highlights the first number. Use the [◀] and [▶] keys to scroll to any number you wish to change.
3. Two alternatives are available to change a highlighted number:
 - Use the numeric keys to enter the desired number.
 - Use the [▼] or [▲] arrow keys to scroll, in 1-digit increments, to the desired number. (For example, if the text box highlights 09, pressing the [▼] key twice changes the number to 07.) You can scroll from 01 to 12 for the hour and from 01 to 59 for the minute and second inputs.
4. In either case, press [ENTER] to confirm the entry.

Entering Date and Time (cont.)

Pressing the [▼] or [▲] arrow keys causes the meter to scroll within the Meter Settings options.

- To confirm the entries and return to Operate mode, press [F3] (OK). The CTF878 returns to Operate Mode.
- To leave the window without confirming the entries, press [F2] (Cancel) or the [ESC] key. The CTF878 returns to Operate Mode.

Changing Date and Time Appearance

In addition to setting the correct date and time, you can also change its presentation to suit local preferences. You can select a time display of AM/PM or 24-hour time.

To alter the time and date display:

1. From the Meter menu, scroll to the Locale tab and press [ENTER]. The Display Options window opens on the Locale tab, as shown in Figure 4-3 below. To step through each parameter, press the [▼] key.

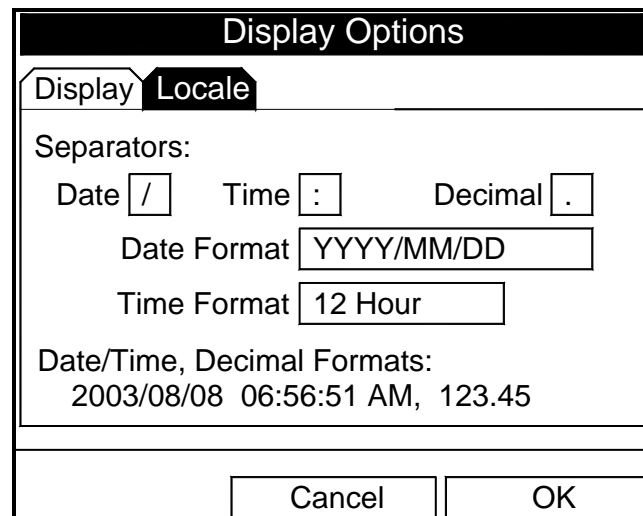

Figure 4-3: Display Options Window - Locale Tab

Changing Date and Time Appearance (cont.)

2. The first series of prompts asks you to select separator symbols for the date, time and decimal. You can choose from a dash, comma and slash (/) for the date; from a period and colon for the time; and from a period or comma for the decimal place. For each symbol type:
 - a. Press [ENTER] to open the drop-down menu.
 - b. Use the [▼] or [▲] arrow keys to scroll to the desired format.
 - c. Press [ENTER] to confirm your entry.
3. The next prompt asks you to select the date format.
 - a. Press [ENTER] to open the drop-down menu. Three options are available:
 - YYYY/MM/DD (year/month/day)
 - MM/DD/YYYY (month/day/year)
 - DD/MM/YYYY (day/month/year)
 - b. Use the [▼] or [▲] arrow keys to scroll to the desired format.
 - c. Press [ENTER] to confirm your entry.
4. The CTF878 now asks you to select whether you want the time presented in a 12-hour format (for example, 11:53:23 PM) or in a 24-hour format (23:53:23).
 - a. Press [ENTER] to open the drop-down menu.
 - b. Use the [▼] or [▲] arrow keys to scroll to the 12-hour or 24-hour entry.
 - c. Press [ENTER] to confirm your entry.

A line at the bottom, the Date/Time, Decimal Formats, displays how the format and separator selections will appear on the screen.

Pressing the [▼] arrow key returns the CTF878 to the Locale tab.

- To confirm the entries and return to Operate mode, press [F3] (OK). The CTF878 returns to Operate Mode.
- To leave the window without confirming the entries, press [F2] (Cancel) or the [ESC] key. The CTF878 returns to Operate Mode.

Adjusting Contrast

For more comfortable viewing in a particular environment, the CTF878 enables you to adjust the screen contrast. To adjust the screen contrast:

1. From the Meter menu, scroll to the Contrast entry and press [ENTER]. The Display Options window opens on the Display tab, as shown in Figure 4-4 below. (From the Format tab, press the [◀] key to move to the Display tab.) To step through each parameter, press the [▼] key.

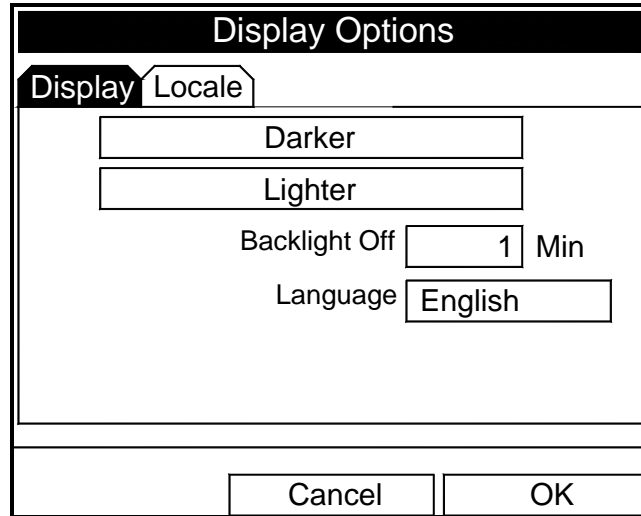

Figure 4-4: Display Options Window - Display Tab

2. Scroll to the Darker or Lighter box as desired.
3. Press the [ENTER] button repeatedly until the screen has the desired contrast.

Note: *If you find the screen has become too light or too dark, scroll to the other box and press [ENTER] until you have adjusted the screen to your satisfaction.*

- To confirm the entries and return to Operate Mode, press [F3] (OK). The CTF878 returns to Operate Mode.
- To leave the window without confirming the entries, press [F2] (Cancel) or the [ESC] key. The CTF878 returns to Operate Mode.

Setting Backlight Timeout

By using the Backlight Timeout option, you can set a specified time that the CTF878 backlight will remain on before turning itself off.

To set the backlight timeout:

1. From the Meter menu, scroll to the Backlight entry and press [ENTER]. The Display Options window opens on the Display tab, as shown in Figure 4-4 on page 4-6.
 2. Press the [▼] key three times to reach the Backlight Off text box.
 3. Then press [ENTER] to enter the box.
 4. Use the numeric keys to enter the number of minutes that the backlight remains on (from 0 to 99).
 5. Press [ENTER] to confirm the entry.
- To confirm the entries and return to Operate mode, press [F3] (OK). The CTF878 returns to Operate Mode.
 - To leave the window without confirming the entries, press [F2] (Cancel) or the [ESC] key. The CTF878 returns to Operate Mode.

Note: *You can turn the backlight on or off at any time by pressing the power switch for 1 second.*

Changing Communications Parameters

On occasion, you might need to change the parameters by which the CTF878 communicates with a PC. While programming, refer to the *Meter Menu Map*, Figure 4-10 on page 4-14.

IMPORTANT: *The parameters set here MUST agree with those set on the PC, or the devices cannot communicate.*

To check or change these parameters:

1. From the Meter menu, scroll to the Communication entry and press [ENTER]. The Communications window appears similar to Figure 4-5 below.

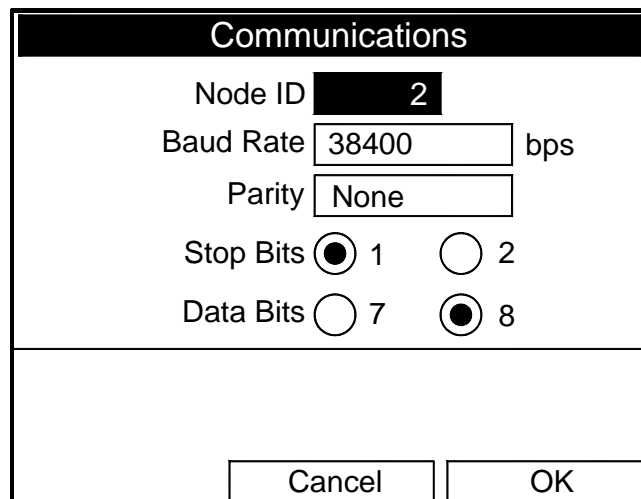

The screenshot shows a window titled "Communications" with the following settings:

| | |
|-----------|--|
| Node ID | 2 |
| Baud Rate | 38400 bps |
| Parity | None |
| Stop Bits | <input checked="" type="radio"/> 1 <input type="radio"/> 2 |
| Data Bits | <input type="radio"/> 7 <input checked="" type="radio"/> 8 |

At the bottom of the window are two buttons: "Cancel" and "OK".

Figure 4-5: Communications Window

2. The first prompt asks for the node identification number, which can be any number from 1 to 240.

IMPORTANT: *Do NOT change the node ID unless instructed by the factory.*

- a. Press [ENTER] to open the text box.
- b. Use the numeric keys to enter the node ID.
- c. Press [ENTER] to confirm the entry.

Changing Communications Settings (cont.)

3. The program now asks for the baud rate. The default rate is 38400 bps.
Note: *Although numbers from 300 to 115,200 are available, baud rates higher than 38,400 are not recommended.*
 - a. Press [ENTER] to open the drop-down menu.
 - b. Use the [▼] or [▲] arrow keys to scroll to the desired rate.
 - c. Press [ENTER] to confirm the entry.
4. The next prompt asks for the parity from five options: None, Even, Odd, Mark, Space. The default parity is None.
 - a. Press [ENTER] to open the drop-down menu.
 - b. Use the [▼] or [▲] arrow keys to scroll to the desired parity.
 - c. Press [ENTER] to confirm the entry.
5. The next prompt asks you to select either one or two stop bits. The default number is 1. Use the [◀] and [▶] keys to scroll to the desired number, and press [ENTER].
6. The final prompt asks you to select either seven or eight data bits. The default number is 8. Use the [◀] and [▶] keys to scroll to the desired number, and press [ENTER].

IMPORTANT: *Using RS-232 requires the following parameters:*

- *Baud Rate -- the number selected in Step 3 above*
 - *Parity -- None*
 - *Stop Bits -- 1*
 - *Data Bits -- 8*
-
- To confirm the entries and return to Operate Mode, press [F3] (OK). The CTF878 returns to Operate Mode.
 - To leave the window without confirming the entries, press [F2] (Cancel) or the [ESC] key. The CTF878 returns to Operate Mode.

Resetting Forward and Reverse Totals

On occasion, it might be necessary to clear and reset the forward and reverse totals computed by the Forward and Reverse Totalizers. To reset the totals:

1. From the Meter menu, scroll to the Totals entry and press [ENTER]. The window now appears similar to Figure 4-6 below.

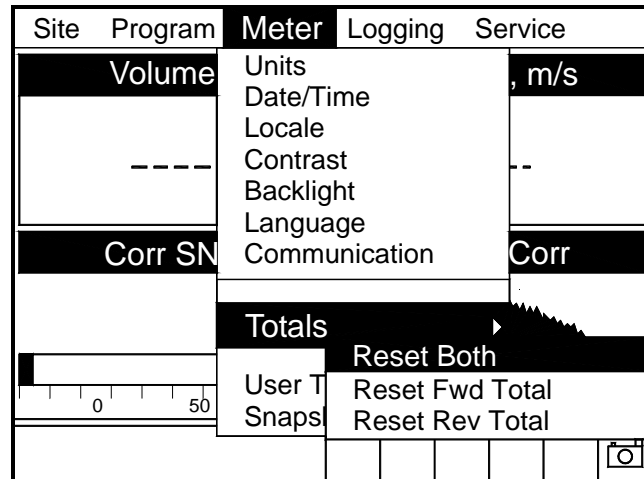

Figure 4-6: Resetting Totals Menu

2. Use the [▼] or [▲] arrow keys to choose the total to be reset.
3. Press [ENTER] to reset the total(s).

The meter resets the selected total(s) to 0.0 and returns to Operate Mode.

Setting Up User Tables

When you program user functions (see page 1-30), you can also support them with up to six user tables of non-linear or empirical data. To program one or more user tables:

1. From the Meter menu, scroll to the User Tables entry and press [ENTER]. The window now appears similar to Figure 4-7 below.

| User Function Tables | |
|----------------------|------------|
| Table | Table 1 |
| Table ID | UserTable1 |
| # Data Points | 0 |
| Max Points | 0 |
| Edit Tables | |
| Cancel OK | |

Figure 4-7: User Tables Window

2. The first prompt asks you to select the table to be programmed.
 - a. Press [ENTER] to open the drop-down menu.
 - b. Use the [▼] or [▲] arrow keys to scroll to the table you wish to program.
 - c. Press [ENTER] to confirm the entry.

Setting Up User Tables (cont.)

3. The next step is to create a Table ID.
 - a. Press [ENTER] to open the window. The screen now appears similar to Figure 4-8 below.

| | | | | | | | | | |
|------------|---|---|--------|---|---|----|---|---|---|
| UserTable1 | | | | | | | | | |
| A | B | C | D | E | F | G | H | I | J |
| K | L | M | N | O | P | Q | R | S | T |
| U | V | W | X | Y | Z | 0 | 1 | 2 | 3 |
| 4 | 5 | 6 | 7 | 8 | 9 | . | / | , | " |
| ' | = | < | > | | | | | | |
| Delete | | | Cancel | | | OK | | | |

Figure 4-8: Text Creation Window

- b. Use the four arrow keys to scroll to the desired letter or symbol, and press [ENTER] to add the letter to the label.
- Note:** Pressing [SEL] causes the screen to alternate between a set of upper-case (capital) letters and a set of symbols. Use both screens to create the desired label.
- c. Repeat this procedure for each letter or symbol you wish to add to the label (up to a total of fourteen characters). If you wish to delete a letter, press [F1] (Delete) to erase each letter or symbol, from right to left on the label.
 - d. When you have completed the label, press [F3] (OK) to confirm the label, or [F2] (Cancel) to leave the window without adding the label.
- Note:** It is not necessary to enter the “# Data Points” or “Max Points” text boxes.

Setting Up User Tables (cont.)

4. The final prompt asks you to enter or change data in the user table.
 - a. Press [ENTER] to open the window. The screen appears similar to Figure 4-9 below.

| Edit User Table 1 | | |
|-------------------|------------|----|
| | | |
| | UserTable1 | Y |
| 1 | | |
| 2 | | |
| 3 | | |
| 4 | | |
| 5 | | |
| Cancel | | OK |

Figure 4-9: Edit User Table Window

- b. Use the four arrow keys to move to the desired entry in the table.
- c. Press [ENTER]. Then use the numeric keys to enter the desired data, which appears in the right corner of the window above the table.
- d. Press [ENTER] to confirm the data, which then appears in the appropriate cell in the table.
- e. Repeat steps b, c and d until you have completed entering data for the table.
- f. When you have finished, press [F3] (OK) to confirm the entries or [F2] (Cancel) to leave the window without confirming the table.

The program returns to the User Functions Tables window.

- To confirm the entries and return to Operate Mode, press [F3] (OK). The CTF878 returns to Operate Mode.
- To leave the window without confirming the entries, press [F2] (Cancel) or the [ESC] key. The CTF878 returns to Operate Mode.

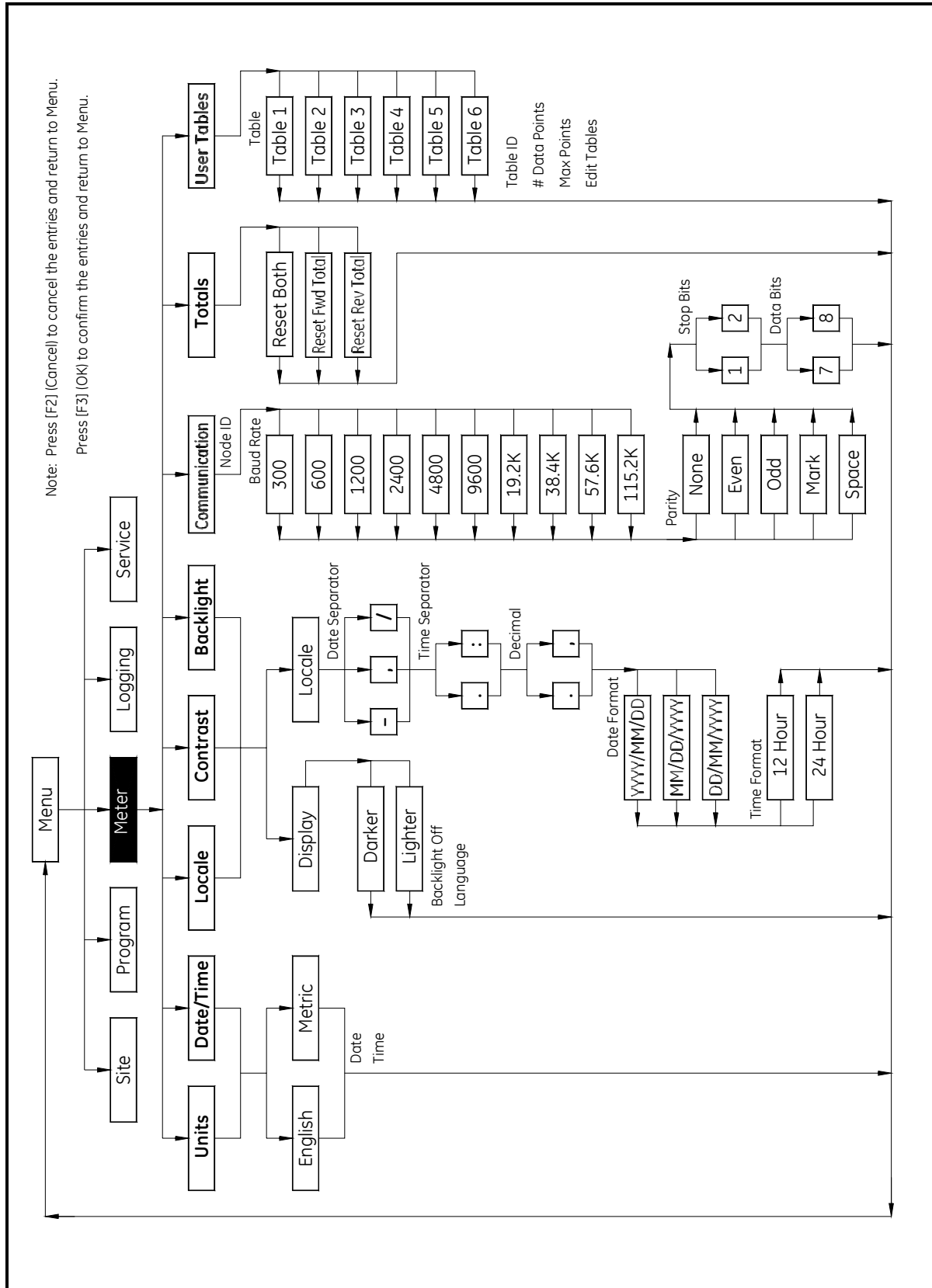

Figure 4-10: Meter Menu Map

Chapter 5

Logging Data

- Introduction..... 5-1
- Entering the Logging Menu 5-1
- Log Manager 5-2
- File Menu 5-3
- Log Menu 5-11
- View Menu 5-13
- Sort Menu..... 5-18

Introduction

A powerful and flexible feature of the CTF878 is data logging. The meter enables you to choose up to 12 parameters to log. You can also select the start time and date, end time and date, and time interval. Logs can run one at a time or simultaneously. Error and circular logs are also available. The logged data is internally stored in battery-backed-up memory. A fixed amount of memory is assigned to data logging. The frequency of the time interval, the length of the log run, and the number of logs affect the amount of memory required for a particular log. For example, a log that records every 5 seconds will use up more memory than a log that records every 5 minutes for a given amount of time. Once you make your data logging selections, the CTF878 enables you to view the amount of memory left. You may also stop logging or view logged data while or after data is logged.

This chapter describes:

- How to enter the Logging Menu.
- How to set up a new log.
- How to view the data logger memory.
- How to start, stop or pause logging

Entering the Logging Menu

To enter the Logging Menu, press the [MENU] key at the lower right of the CTF878 keypad. The Main Menu replaces the Status Bar at the top of the screen. Use the [▶] arrow key to scroll to the Logging Menu. At the Logging Menu, press [ENTER]. The screen appears similar to Figure 5-1 below. Refer to the *Logging Menu Map*, Figure 5-18 on page 5-19.

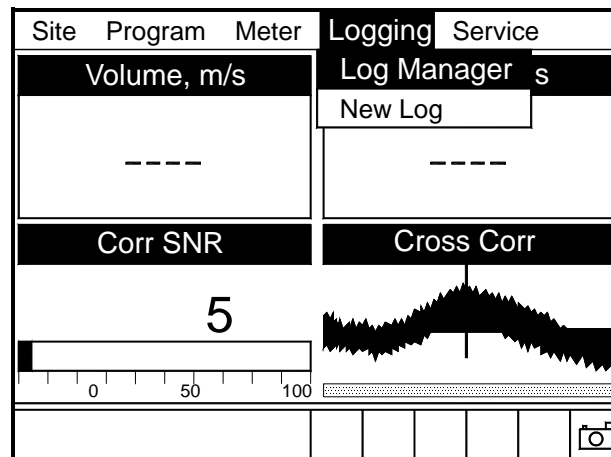

Figure 5-1: Logging Menu

Entering the Logging Menu (cont.)

To scroll to a particular option, press the [▼] or [▲] arrow key until you reach the option. Then press [ENTER] to open the option window.

When entering parameters in an option, press:

- The [▼] key to step through the available parameters
- The [▲] key to scroll back to a previously entered parameter
- The [F2] key (Cancel) or the [ESC] key to exit an option at any time and return to Operate Mode without changing the parameters.

Log Manager

The Log Manager offers users a way to check the status and memory size of all the logs currently pending, running or finished. To select Log Manager, scroll to the Log Manager entry on the Logging Menu and press [ENTER]. If no logs have been entered, the screen appears similar to Figure 5-2 below. If logs have been entered, the right section of the screen supplies information for a log highlighted on the left. Use the [▼] and [▲] arrow keys to scroll to a particular log and display information pertaining to that log.

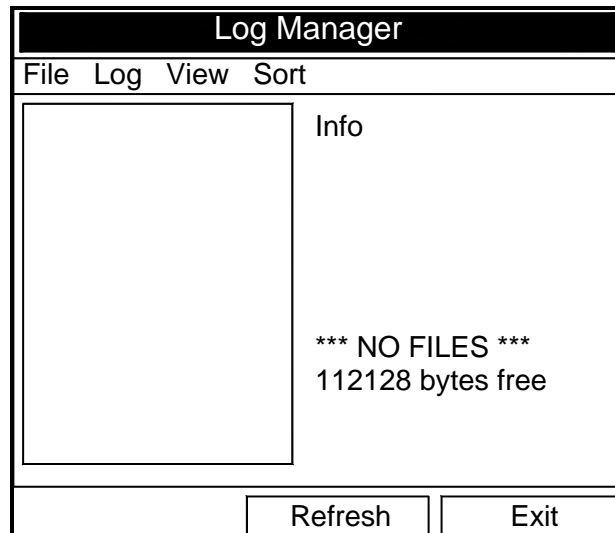

Figure 5-2: Log Manager Window

To access the menu for the Log Manager, press the [MENU] key. The cursor highlights the File Menu in the upper left corner. Use the [◀] and [▶] keys to scroll to the desired menu, and press [ENTER] to open the menu.

File Menu

The File menu enables you not only to create new logs, but also to clone, rename, delete, refresh, or print existing logs. To open the File Menu from the Log Manager, press the [MENU] key and then [ENTER]. The screen appears similar to Figure 5-3 below.

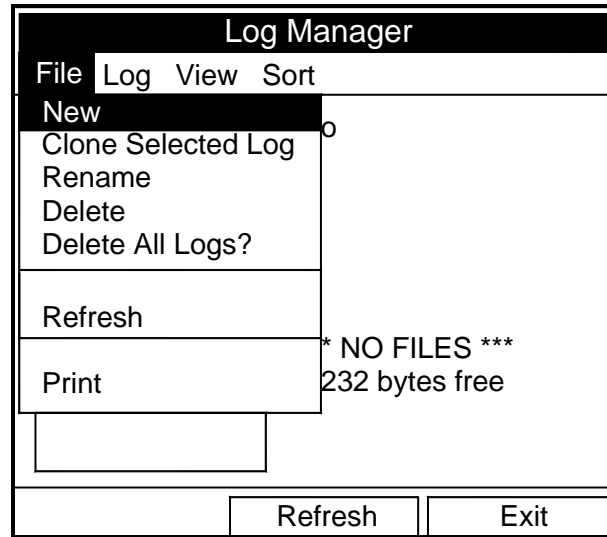

Figure 5-3: File Menu in the Log Manager

Entering General Information

Figure 5-5: General Log Format Window

To step through each parameter, press the [▼] key.

1. The first prompt asks you to choose between a linear or circular format for the log.

Note: A linear log automatically stops when the meter runs out of memory or the specified End time is reached. A circular log runs continuously until manually stopped, but only the data from the most recent log cycle is saved.

- a. Use the [◀] and [▶] keys to scroll to the appropriate radio button.
 - b. Press [ENTER] to confirm your selection.
2. The next prompt asks you to choose whether the log is to be a standard or error log.

Note: A standard log is used to log up to three of the available measurement data parameters. An error log is used to log any generated error messages.

- a. Use the [◀] and [▶] keys to scroll to the appropriate radio button.
- b. Press [ENTER] to confirm your selection.

Entering General Information (cont.)

3. The next prompt asks for the starting date and time.
 - a. Press [ENTER] to enter the text box. The meter highlights the first number. Use the [◀] and [▶] keys to scroll to any number you wish to change, or the [▶] key to scroll to the time box.
 - b. Use the numeric keys to enter the desired number.
or
Use the [▼] or [▲] arrow keys to scroll, in 1-digit increments, to the desired number. (For example, if the text box displays 09, pressing the [▼] key twice changes the number to 07.) Scroll from 01 to 12 for the month and from 01 to 31 for the day (depending on the number selected for the month).
 - c. In either case, press [ENTER] to confirm the entry.
4. Follow the same procedure to enter the end date and time.

Note: *A circular log does not have an end time, but a number of records. If you select a circular log, Number of Records replaces End. To edit the number of records, scroll to Number of Records and press [ENTER]. Type the value for that parameter and press [ENTER] again.*
5. The final prompt in this window asks for the logging interval.
 - a. Press [ENTER] to open the text box.
 - b. Use the numeric keys to enter the desired interval in seconds.
 - c. Press [ENTER] to confirm the entry.
6. You have completed entering parameters in this window. To select the measurements,
 - a. Press the [▼] key to return to the Format prompt.
 - b. Then press the [▲] key to return to the General tab.
 - c. Finally, press the [▶] key to move to the Measurements tab, and press [ENTER]. The Measurements window appears similar to Figure 5-7 on page 5-7.

To step through each entry, press the [▼] key.

Entering Measurements

1. Press [ENTER] to open the first entry. The Select Measurement window opens, as shown in Figure 5-6 below.

| Select Measurement | |
|--------------------|--------|
| DIAG | m/s |
| Velocity | |
| UserFunction | |
| AuxIn | |
| Pressure | |
| Temperature | |
| Volume | |
| Fwd Totalizer | |
| Rev Totalizer | |
| No Unit | Cancel |
| | OK |

Figure 5-6: Select Measurement Window

2. Scroll to the desired output type.
3. Press [SEL] to confirm your selection.
4. The prompt then moves to a list of unit types or to a list of diagnostic parameters if the DIAG category is shown. Scroll to the desired output unit or diagnostic parameter.
5. Press [F3] (OK) to confirm your selection. A screen similar to Figure 5-7 appears.

| General | Measurements |
|-----------------|--------------|
| Velocity m/s | NO UNIT |
| NO UNIT | NO UNIT |
| NO UNIT | NO UNIT |
| NO UNIT | NO UNIT |
| NO UNIT | NO UNIT |
| NO UNIT | NO UNIT |
| | Cancel |
| | Activate |

Figure 5-7: Measurements and Units Selected

*Entering Measurements
(cont.)*

6. You can repeat this procedure for up to 12 different parameters.
7. When you have finished, press [F2] (Cancel) to cancel the entries, or [F3] (Activate) to confirm the entries and start the log.

If you started the log from the New Log option, the CTF878 returns to Operate Mode, with a Pencil icon (with marks) in the System Tray (see Figure 5-8 below). If you started it from within the Log Manager, the meter returns to the Log Manager.

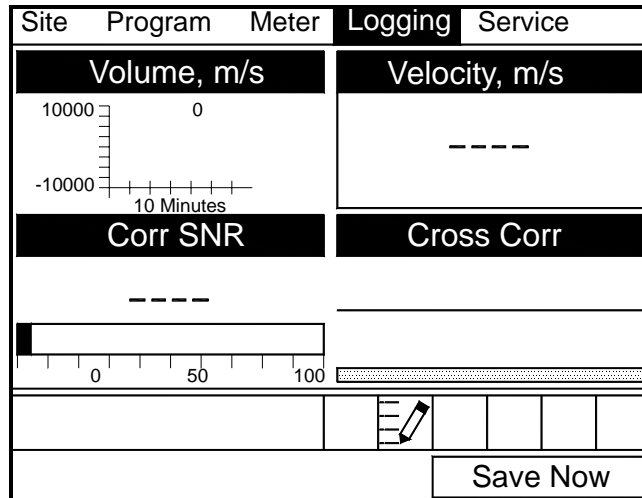

Figure 5-8: Operate Mode After New Log Entry

Copying (Cloning) a Selected Log

In the Clone Selected Log option, you can copy the parameters of a particular log, modify the parameters, and start the copy. To copy a log:

1. First, select the log you wish to copy in the Log Manager (see Figure 5-2 on page 5-2).
2. Then press [MENU], open the File Menu, scroll to the Clone Selected Log option, and press [ENTER].
3. The Create New Log window (shown in Figure 5-4 on page 5-4) opens. Follow the procedure discussed on page 5-4 to create a log name, and press [F3] (OK) to confirm the name.
4. The General Log Format window (see Figure 5-5 on page 5-5) opens. Follow the procedure which begins on page 5-5 to change any settings.

Note: *Unless otherwise specified, the cloned log always begins at the current date and time, and ends after the period of time used by the original log.*

5. If you wish, scroll to the Select Measurements window (see Figure 5-6 on page 5-7) and follow the procedure discussed on page 5-7 to modify any parameters.
6. When you have completed modifying the log parameters, press [F2] (Cancel) to cancel the log or [F3] (Activate) to confirm and start the new log.

The CTF878 returns to the Log Manager, which now displays the status of the cloned log.

Renaming a Log

To rename a log:

1. First, select the log you wish to rename in the Log Manager (shown in Figure 5-2 on page 5-2).
2. Then open the File Menu, scroll to the Rename option, and press [ENTER].
3. The Rename Log window opens. (Except for the heading, the window is identical to the Create New Log window shown in Figure 5-4 on page 5-4.) Follow the procedure discussed on page 5-4 to create a log name, and press [F3] (OK) to confirm the name.

The CTF878 returns to the Log Manager, which highlights the renamed log.

Deleting a Log

To delete a log:

1. First, select the log you wish to delete in the Log Manager (shown in Figure 5-2 on page 5-2).
2. Then open the File Menu, scroll to the Delete option, and press [ENTER].
3. A delete confirmation window opens, as shown in Figure 5-9 below. Press [F2] (No) to stop the deletion, or [F3] (Yes) to delete the log.

The Log Manager reappears, with the specified log deleted.

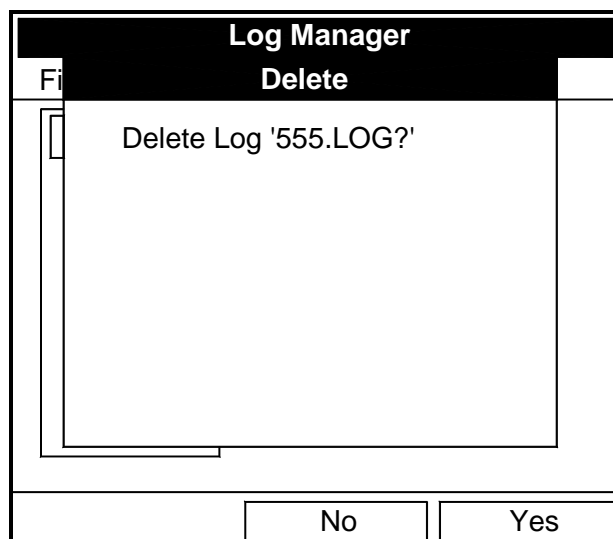

Figure 5-9: Delete Confirmation Window

Deleting All Logs

To clear the Log Manager and memory of all logs, open the File menu, scroll to the Delete All Logs option, and press [ENTER]. A window opens, asking, "Delete All Logs?"

- Press [F2] (No) to stop the deletion, or
- *Press [F3] (Yes) to delete the logs. A blank Log Manager appears. All logs have been deleted.*

Refreshing the Log Manager Screen

To refresh the Log Manager screen and view the most recent information on a given log, select the log you wish to view in the Log Manager. Then open the File Menu, scroll to the Refresh option, and press [ENTER]. The screen momentarily blanks, and then reappears with the most current information on the highlighted log.

Log Menu

The Log Menu allows you to pause, restart or end any or all logs that are currently pending or running. (However, you cannot restart any finished logs, even if they were finished before the programmed end time.) To open the Log Menu in the Log Manager, press [MENU]. Scroll to the Log option, and press [ENTER]. The window appears similar to Figure 5-10 below.

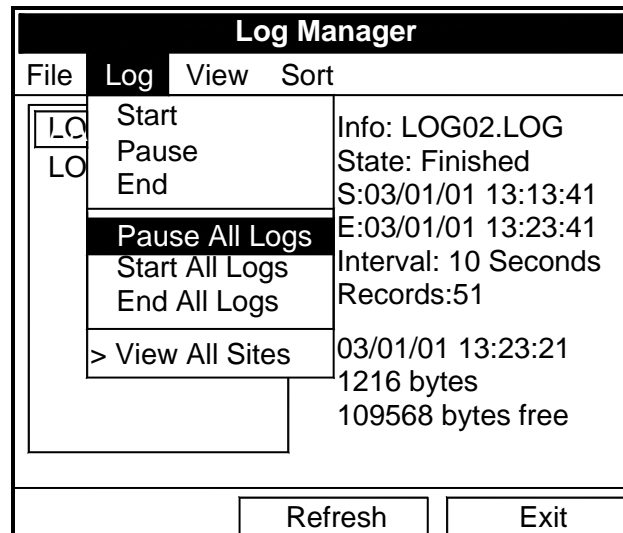

Figure 5-10: Log Menu in the Log Manager

Stopping (Pausing) a Log

To stop a log that is currently pending or running,

1. First, select the log you wish to pause in the Log Manager (shown in Figure 5-2 on page 5-2).
2. Then open the Log Menu, scroll to the Pause option, and press [ENTER].

The CTF878 returns to the Log Manager, which displays the highlighted log with “Paused” in the State line.

Restarting a Log

To restart a paused log:

1. First, select the log you wish to restart in the Log Manager (shown in Figure 5-2 on page 5-2).
2. Then open the Log Menu, scroll to the Start option, and press [ENTER].

The CTF878 returns to the Log Manager, which displays the highlighted log with a status of “Pending” or “Running.”

Ending a Log

To end a log:

1. First, select the log you wish to end in the Log Manager (shown in Figure 5-2 on page 5-2).
2. Then open the Log Menu, scroll to the End option, and press [ENTER].

The CTF878 returns to the Log Manager, which displays the highlighted log with a status of “Finished.” The space not used by the finished log is freed for reuse.

Note: *You cannot restart a finished log. You must create a new log with the same parameters.*

Stopping All Logs

To stop all logs that are currently pending or running, open the Log Menu, scroll to the Pause All Logs option, and press [ENTER]. The CTF878 returns to the Log Manager, which displays all logs programmed to run now or in the future with a status of “Paused.”

Restarting All Logs

To restart all paused logs, open the Log Menu, scroll to the Start All Logs option, and press [ENTER]. The CTF878 returns to the Log Manager, which displays the logs with a status of “Pending” or “Running.”

Ending All Logs

To end all currently pending or running logs, open the Log Menu, scroll to the End All Logs option, and press [ENTER]. The CTF878 returns to the Log Manager, which displays the running logs with a status of “Finished.”

View All Sites

To check on all logs, open the Log Menu, scroll to the View All Sites option, and press [ENTER]. Logs are associated with the site in use at the time the log is created. Thus, when another site is in use, the CTF878 automatically starts different logs. By default, the Log Manager only displays the logs created with the current site. View All Sites allows the Manager to list logs for all sites.

View Menu

Through the View menu, you can view the data of individual logs in graphical or spreadsheet formats. To open the View menu from the Log Manager, press [MENU]. Scroll to the View menu, and press [ENTER]. The screen appears similar to Figure 5-11 below.

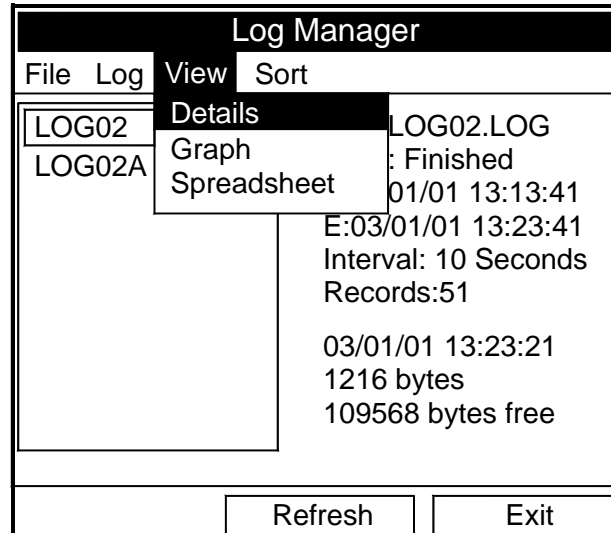

Figure 5-11: View Menu

Displaying Log Details

To view details of a given log, be sure the log is highlighted in the left window of the Log Manager. Then scroll to the View menu and press [ENTER]. Scroll to the Details option and press [ENTER]. The screen now appears similar to Figure 5-12 below.

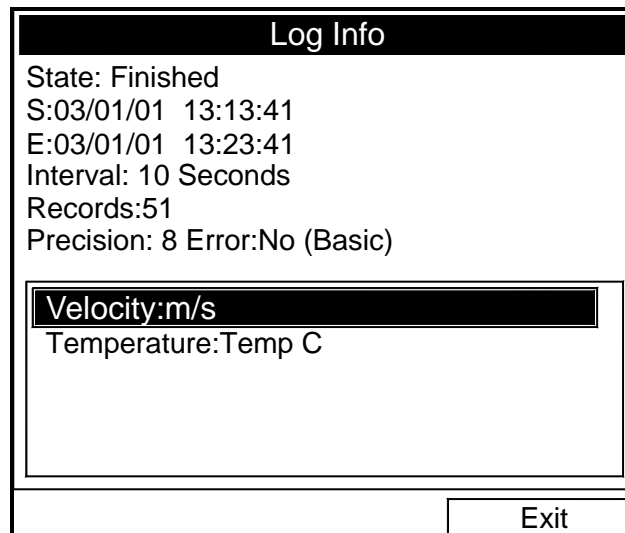

Figure 5-12: Log Details Display Window

Press [F2] (Cancel) or [F3] (OK) to return to the Log Manager.

Displaying Log Data in Graphical Form

To view a log in graphical format, be sure the log is highlighted in the left window of the Log Manager. Then scroll to the View menu and press [ENTER]. Scroll to the Graph option and press [ENTER].

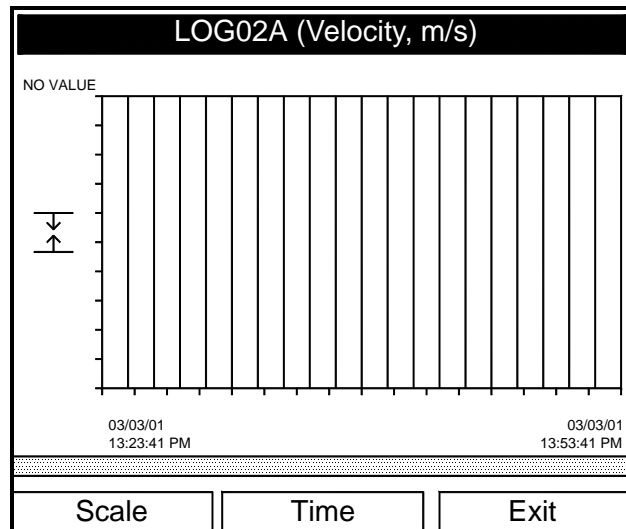

Figure 5-13: Log Graph Display Window

The Select Measurement window opens and lists the log measurement parameters. If a log contains more than one measurement, you must select which measurement to plot from the list displayed. Once you have chosen the measurement parameter, press [F3] (View). The screen now appears similar to Figure 5-13 above. Press [F2] (Cancel) to leave the window without viewing the graph.

- If you wish to alter the graph scale, press [F1] (Scale) and go to page 5-15.
- If you wish to alter the time scale, press [F2] (Time) and go to page 5-16.
- To leave the window, press [F3] (Exit).

Displaying Log Data in Graphical Form (cont.)

Figure 5-14: Y-Axis Window

The Y-Axis window (shown in Figure 5-14 above) allows you to specify whether the Y axis on the graph extends to the maximum value (Max), over the entire range (Range) or between certain specified values (Set).

1. Use the [◀] and [▶] keys to scroll to the desired limit type. Press [ENTER] to confirm the entry.

If you select Max or Range for limits, you have finished entering data in this form. But if you select Set, the CTF878 asks for minimum and maximum limits.

2. Press the [▼] key to reach the Minimum text box.
 - a. Press [ENTER] to open the text box.
 - b. Use the numeric keys to enter the desired value.
 - c. Press [ENTER] to confirm the entry.
3. Repeat step 2 to enter the Maximum value.
4. When you have finished, press [F2] (Cancel) to cancel the entries, or [F3] (OK) to confirm the entries and change the graph.

Displaying Log Data in Graphical Form (cont.)

If you wish to alter the time scale, press [F2] (Time). The Enter Time window appears similar to Figure 5-15 below.

The screenshot shows a terminal window titled "LOG02A (Velocity, m/s)". At the top left, it says "NO VALUE". Below that is a header "Enter Time". The main area contains four input fields arranged in a 2x2 grid:

| | |
|------------|------------|
| Start Date | Start Time |
| 2003/08/08 | 8:16:50 AM |
| End Date | End Time |
| 2003/08/08 | 8:34:58 AM |

Below the input fields is a horizontal timeline with vertical tick marks. The start of the timeline is labeled "03/08/08 8:16:50 AM" and the end is labeled "03/08/08 8:34:58 AM". At the bottom of the window are two buttons: "Cancel" and "OK".

Figure 5-15: Enter Time Window

1. Use the arrow keys to scroll to the desired text box. Press [ENTER] to open the box.
2. Use the numeric keys to enter the desired number.
or
Use the [▼] or [▲] arrow keys to scroll, in 1-digit increments, to the desired number. (For example, if the text box displays 09, pressing the [▼] key twice changes the number to 07.) Scroll from 01 to 12 for the month, from 01 to 31 for the day (depending on the number selected for the month), and from 0 to 59 for minutes and seconds.
3. In either case, press [ENTER] to confirm the entry.
4. Repeat step 2 for any other entries you wish to change.

When you have finished, press [F3] (OK) to confirm the entries and close the window, or press [F2] (Cancel) to leave the window without changing the entries.

Displaying Log Data in Spreadsheet Form

To view a log in spreadsheet form, be sure the log is highlighted in the left window of the Log Manager. Then scroll to the View menu and press [ENTER]. Scroll to the Spreadsheet option and press [ENTER]. The screen now appears similar to Figure 5-16 below.

| LOG02A.LOG | | |
|------------|----------|-------------|
| Time | Velocity | Temperature |
| 03/08/08 | m/s | Temp C |
| 08:16:50 | 0.00 | 15.6 |
| 08:17:50 | 0.00 | 15.6 |
| 08:18:51 | 0.00 | 15.6 |
| 08:19:51 | 0.00 | 15.6 |
| 08:20:52 | 0.00 | 15.6 |
| 08:21:52 | 0.00 | 15.6 |
| 08:22:53 | 0.00 | 15.6 |
| | | |
| Time | Refresh | Exit |

Figure 5-16: Log Spreadsheet Window

Use the [◀] and [▶] keys to scroll to other columns, or the [▼] or [▲] keys to scroll backward or forward in time.

- To alter the times displayed, press [F1] (Time). The Enter Time window (shown on the previous page) opens. Follow the instructions on the previous page to change the date or time.
- To refresh the display, press [F2] (Refresh). The display shows the most current data.
- Press [F3] (Exit) to return to the Log Manager.

Sort Menu

The Sort Menu within the Log Manager allows you to arrange your log list either alphabetically (By Name) or chronologically (By Date).

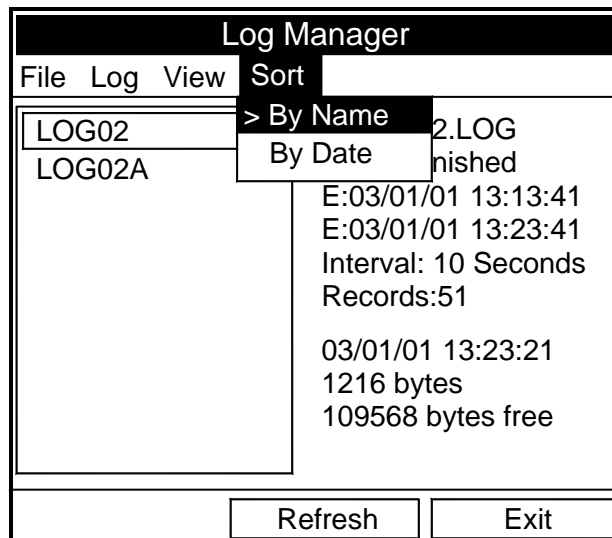

Figure 5-17: Sort Menu in the Log Manager

Listing Logs by Name

If you want to list your logs alphabetically by log name within the Log Manager, press [MENU] to open the File Menu. Then scroll from the File Menu to the Sort Menu, scroll to the By Name option (see Figure 5-17 above), and press [ENTER]. The Log Manager screen refreshes, with the sites listed in alphabetical order.

Listing Logs in Chronological Order

If you prefer to list your logs chronologically by time of creation within the Log Manager, press [MENU] to open the File Menu. Then scroll from the File Menu to the Sort Menu, scroll to the By Date option, and press [ENTER]. The Log Manager screen refreshes, with the sites listed in chronological order, from the most recent to the earliest.

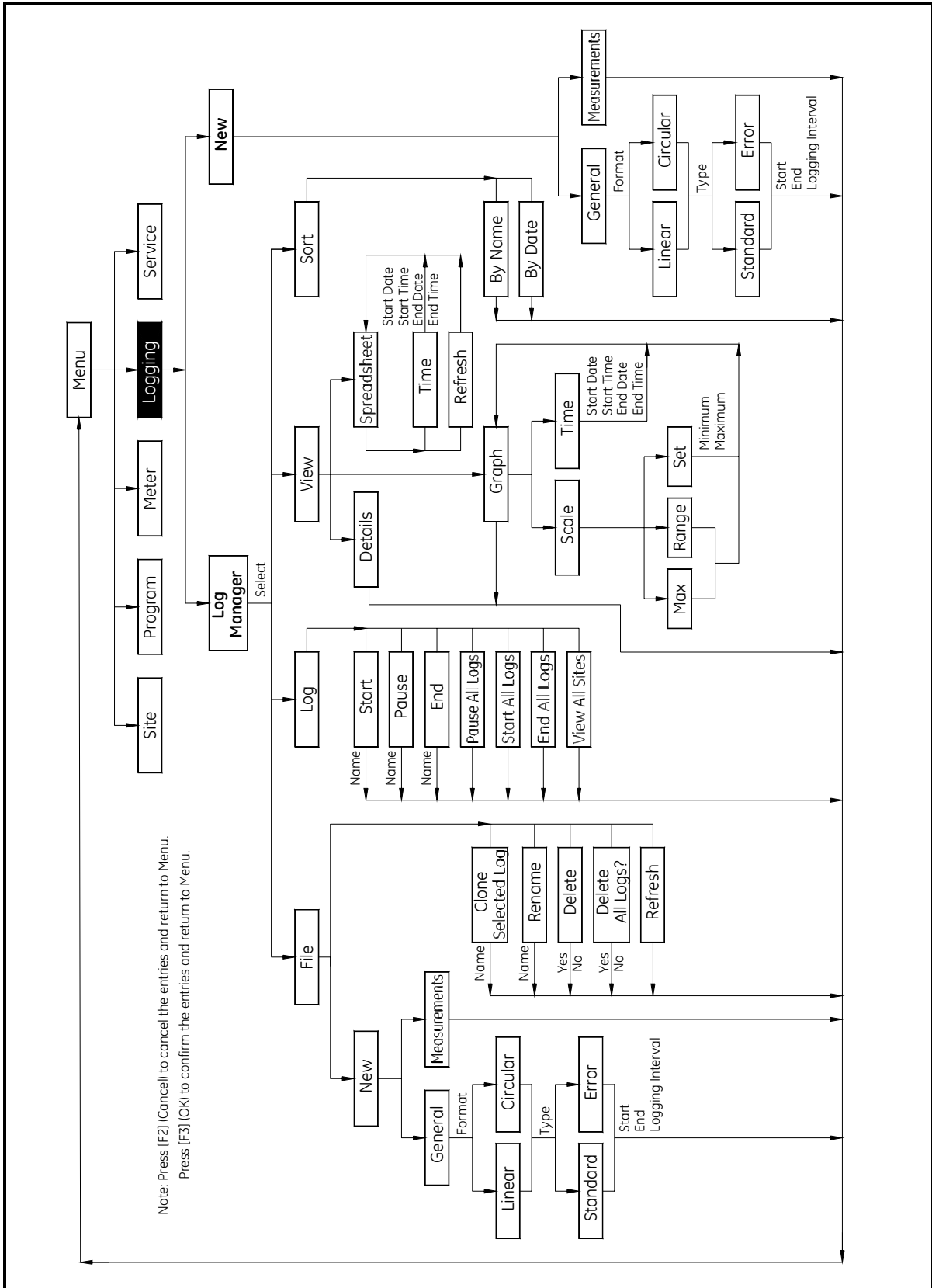

Figure 5-18: Logging Menu Map

Index

| | | | |
|---|----------|------------------------------------|------------|
| A | | F | |
| About Option | 2-10 | Fluid Option | 1-14 |
| Analog Inputs | | Format Option | 2-2 |
| Entering | 1-17 | Forward Total, Resetting | 4-10 |
| Menu Map | 1-39 | | |
| Analog Outputs | | G | |
| Entering | 1-20 | Graph Display | 2-3 |
| Menu Map | 1-38 | | |
| Span (Full Scale) Value | 1-22 | I | |
| Zero (Base) Value | 1-21 | Icons in the System Tray | 1-3 |
| B | | Input/Output Menu Map | 1-38, 1-39 |
| Backlight | 4-7 | Inputs, Analog | 1-17 |
| Bar Graph Display | 2-3 | | |
| C | | K | |
| Calibration Factor, Entering | 1-33 | Keypad | |
| Clamp-On Transducers, Path Parameters | 1-16 | Description | 1-4 |
| Clearing Softkeys | 2-10 | Table of Functions | 1-5 |
| Communications, Changing Parameters | 4-8 | Using | 1-4 |
| Configuring the Display | 2-1 | Keys, Function | 1-5 |
| Contrast, Adjusting | 4-6 | | |
| D | | | |
| Data Sources, Changing | 2-5 | | |
| Date and Time Options | 4-4 | | |
| Date, Entering | 4-3 | | |
| Date/Time Format, Changing | 4-4 | | |
| Digital Output Option | 1-23 | | |
| Digital Outputs | | | |
| Menu Map | 1-39 | | |
| Display | | | |
| Bar Graph | 2-3 | | |
| Configuring | 2-1, 2-6 | | |
| Icons | 1-3 | | |
| Line Graph | 2-3 | | |
| Parameters | 2-7 | | |
| Screen | 1-2, 2-6 | | |
| Display Options | 4-4 | | |

Index (cont.)

| L | M |
|------------------------------------|--|
| Limits Option 2-3 | Measurement Option 2-5 |
| Line Graph Display 2-3 | Measurement Parameters, Changing 2-5 |
| Listing Files | Measurement Units, Selecting 4-2 |
| by Name 3-11 | Menu Map |
| Listing Logs | Analog Inputs 1-39 |
| by Date 5-18 | Analog Outputs 1-38 |
| by Name 5-18 | Digital Outputs 1-39 |
| Locale Option 4-4 | Input/Output 1-38, 1-39 |
| Log Manager 5-2 | Logging 5-19 |
| Copying a Log 5-9 | Meter 4-14 |
| Creating a New Log 5-4 | Program 1-37 |
| Deleting a Log 5-10 | RTDs 1-39 |
| Deleting All Logs 5-10 | Site 3-12 |
| Displaying Details 5-13 | Meter Menu Map 4-14 |
| Ending a Log 5-12 | Meter Menu, Entering 4-1 |
| Ending All Logs 5-12 | Meter Settings Window 4-2 |
| File Menu 5-3 | Model number 2-10 |
| Graphical Format 5-14 | |
| Log Menu 5-11 | N |
| Renaming a Log 5-9 | Node ID for Communications 4-8 |
| Restarting a Log 5-11 | |
| Restarting All Logs 5-12 | O |
| Sort Menu 5-18 | Outputs |
| Spreadsheet Format 5-17 | Analog 1-20 |
| Stopping a Log 5-11 | Digital 1-23 |
| Stopping All Logs 5-12 | |
| View All Sites 5-12 | P |
| Log Menu 5-11 | Parameters, Displaying 2-7 |
| Logging Menu Map 5-19 | Path Option 1-15 |
| | Path Parameters, Clamp-On Transducers 1-16 |
| | Pipe Option |
| | Diameter, Entering 1-12 |
| | Dimensions, Schedule for 1-12 |
| | Material, Entering 1-11 |
| | Powering On and Off 1-1 |
| | Program Menu Map 1-37 |
| | Program Menu, Entering 1-6 |
| | R |
| | Refreshing a Site 3-8 |
| | Reverse Total, Resetting 4-10 |
| | RTDs Menu Map 1-39 |

Index (cont.)

S

| | |
|--|------------|
| Screen | |
| Customizing the Display | 2-6 |
| Description | 1-2 |
| Signal Path | 1-15 |
| Site Manager | 3-1 |
| Sites | |
| Creating | 3-4 |
| Deleting | 3-10 |
| Managing | 3-1 |
| Menu Map | 3-12 |
| Opening | 3-6 |
| Refreshing | 3-8 |
| Renaming | 3-9 |
| Saving. | 3-7 |
| Saving with a Different Name | 3-8 |
| Softkeys | |
| Clearing | 2-10 |
| Customizing | 2-8 |
| Software Version | 2-10 |
| Sort Menu. | 3-11, 5-18 |
| Span (Full Scale) Value | 1-22 |
| Special Transducers | |
| Entering Data | 1-9 |

T

| | |
|-----------------------------|------|
| Time, Entering | 4-3 |
| Totals, Resetting. | 4-10 |
| Transducers | |
| Entering Data for | 1-7 |
| Special | 1-9 |

U

| | |
|--------------------------|------|
| Units Option | 4-2 |
| User Functions | 1-30 |
| User Tables. | 4-11 |

V

| | |
|------------------------------------|------|
| View Menu in Log Manager | 5-13 |
| View Option | 2-3 |

Z

| | |
|------------------------------|------|
| Zero (Base) Valuet | 1-21 |
|------------------------------|------|

We,

Panametrics Limited
Shannon Industrial Estate
Shannon, County Clare
Ireland

declare under our sole responsibility that the

CTF878 Ultrasonic Flowmeter

to which this declaration relates, are in conformity with the following standards:

- EN 61326:1998, Class A, Annex A, Continuous Unmonitored Operation
- EN 61010-1:1993 + A2:1995, Overvoltage Category II, Pollution Degree 2

following the provisions of the 2004/108/EC EMC Directive and the 2006/95/EC Low Voltage Directive.

Shannon - April 15, 2004

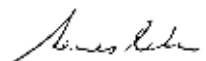

Mr. James Gibson
GENERAL MANAGER



CERT-DOC-H0



August 2004

Nous,

Panometrics Limited
Shannon Industrial Estate
Shannon, County Clare
Ireland

déclarons sous notre propre responsabilité que les

CTF878 Ultrasonic Flowmeter

relatif à cette déclaration, sont en conformité avec les documents suivants:

- EN 61326:1998, Class A, Annex A, Continuous Unmonitored Operation
- EN 61010-1:1993 + A2:1995, Overvoltage Category II, Pollution Degree 2

suivant les règles de la Directive de Compatibilité Electromagnétique 2004/108/EC et de la Directive Basse Tension 2006/95/EC.

Shannon - April 15, 2004

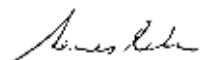

Mr. James Gibson
DIRECTEUR GÉNÉRAL



CERT-DOC-H0



August 2004

Wir,

Panametrics Limited
Shannon Industrial Estate
Shannon, County Clare
Ireland

erklären, in alleiniger Verantwortung, daß die Produkte

CTF878 Ultrasonic Flowmeter

folgende Normen erfüllen:

- EN 61326:1998, Class A, Annex A, Continuous Unmonitored Operation
- EN 61010-1:1993 + A2:1995, Overvoltage Category II, Pollution Degree 2

gemäß den Europäischen Richtlinien, Niederspannungsrichtlinie Nr.: 73/23/EG und EMV-Richtlinie Nr.: 89/336/EG.

Shannon - April 15, 2004

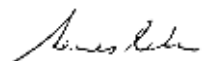

Mr. James Gibson
GENERALDIREKTOR



CERT-DOC-H0



August 2004



USA

1100 Technology Park Drive
Billerica, MA 01821-4111
Web: www.gesensing.com

Ireland

Sensing House
Shannon Free Zone East
Shannon, Co. Clare
Ireland

