

# Quick Start

Edition 10/2009 - Revision 07

## SITRANS F M

### MAG 5000 & MAG 6000 IP 67, 19"

- Ⓔ EN Electromagnetic flowmeter transmitter types MAG 5000 & MAG 6000 IP 67, 19"
- Ⓓ DE Messumformer für magnetisch-induktive Durchflussmesser Typen MAG 5000 & MAG 6000 IP 67, 19"
- Ⓕ FR Transmetteurs pour débitmètres magnéto-inductifs types MAG 5000 & MAG 6000 IP 67, 19"
- Ⓔ ES Transmisor para los caudalímetros electromagnéticos tipos MAG 5000 & MAG 6000 IP 67, 19"

MAG 5000 & MAG 6000 IP 67



Ⓔ EN Items Supplied  
Ⓓ DE Lieferumfang

Ⓕ FR Pièces fournies  
Ⓔ ES Ítems suministrados

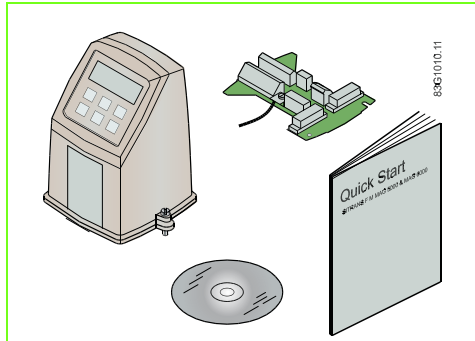

MAG 6000 19"

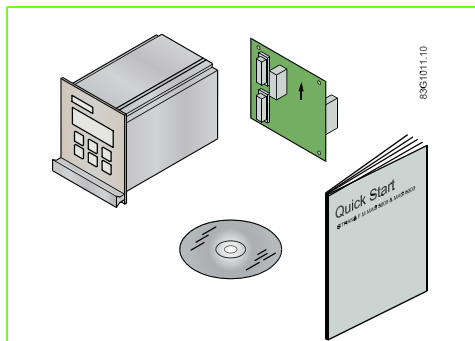

- Ⓔ EN For more information see the operating instructions on the enclosed CD-ROM.
- Ⓓ DE Weitere Informationen siehe Betriebsanleitung auf der beigefügten CD-ROM.
- Ⓕ FR Pour plus de détail consulter les instructions de service sur le CD-ROM fourni.
- Ⓔ ES Para más información ver los instrucciones de servicio en el CD-ROM.

**SIEMENS**

## **EN** General instructions

Before installing, including in hazardous areas, please refer to the operating instructions on the enclosed CD-ROM for detailed safety regulations, information and specifications which must be observed when installing.

Changes can occur. Documentation and approvals can be found on the Internet at [www.siemens.com/flowdocumentation](http://www.siemens.com/flowdocumentation)

### **Warning**

Correct, reliable operation of the product requires proper transport, storage, positioning and assembly as well as careful operation and maintenance. Only qualified personnel should install or operate this instrument.

## **DE** Allgemeine Hinweise

Vor Einbau, einschließlich in Ex-Bereichen, lesen Sie die Betriebsanleitung auf der beigefügten CD-ROM. Sie enthält die beim Einbau zu beachtenden Sicherheitsvorschriften, Hinweise und technischen Daten.

Änderungen vorbehalten. Dokumentationen und Zulassungen finden Sie im Internet unter [www.siemens.com/flowdocumentation](http://www.siemens.com/flowdocumentation)

### **Warnung**

Der einwandfreie und sichere Betrieb des Produktes setzt sachgemäßen Transport, sachgemäße Lagerung, Aufstellung und Montage sowie sorgfältige Bedienung und Instandhaltung voraus. Inbetriebsetzung und Betrieb dieses Gerätes/Systems dürfen nur von qualifiziertem Personal vorgenommen werden.

## **FR** Instructions générales

Avant l'installation, y compris en zone dangereuse, veuillez consulter les consignes de sécurité, les informations et les spécifications dans les instructions de service correspondant, disponible sur le CD-ROM fourni.

Des modifications pouvant être apportées, vous trouverez l'ensemble des documents et agréments mis à jours sur internet à l'adresse [www.siemens.com/flowdocumentation](http://www.siemens.com/flowdocumentation).

### **Avertissement**

Le fonctionnement fiable et sécuritaire du produit implique le respect des consignes de transport, de stockage, de montage et de mise en service ainsi qu'une utilisation et maintenance soigneuses. Seul le personnel qualifié doit installer ou utiliser l'instrument.

## **ES** Instrucciones generales

Antes de instalar el aparato (incluso en entornos peligrosos), consultar las normas de seguridad, las especificaciones y los datos técnicos proporcionados en los instrucciones de servicio incluido en el CD-ROM. Sujeto a cambios sin previo aviso.

La documentación y las aprobaciones están disponibles en internet: [www.siemens.com/flowdocumentation](http://www.siemens.com/flowdocumentation).

### **Advertencia**

El funcionamiento correcto y fiable del producto requiere un transporte, almacenamiento, colocación y montaje adecuados así como una utilización y mantenimiento cuidadosos. Este instrumento sólo debe ser instalado y utilizado por personal calificado.

## MAG 5000/MAG 6000

(EN) Compact installation

(FR) Montage compact

(DE) Kompakte Montage

(ES) Instalación compacta

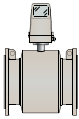

(EN) Ensure power is off before installation!

- A) Connect as shown to register flow reading.  
 B) Connect PE (ground) wire.  
 C) Connect power supply.  
 D) Connect output cable.  
**Cable clamp only required for bus communication cables, supplied with bus module.**

(DE) Prüfen Sie vor dem Einbau, ob das Gerät stromlos ist!

- A) Wie abgebildet anschließen, um Durchflussdaten aufzuzeichnen.  
 B) PE-Schutzleiter anschließen.  
 C) Stromversorgung anschließen.  
 D) Ausgangskabel anschließen.  
**Kabelklemme nur für Bus-Kommunikationskabel erforderlich, im Lieferumfang des Busmoduls enthalten.**

(FR) Vérifier que le système soit hors tension avant de l'installer!

- A) Connecter tel qu'illustré pour enregistrer les mesures de débit.  
 B) Connecter le conducteur de protection PE.  
 C) Connecter l'alimentation.  
**Serre-câble fourni avec le module bus; requis uniquement pour les câbles de communication.**

(ES) ¡Cerciórese de que la alimentación está apagada antes de la instalación!

- A) Conecte como es mostrado para registrar la lectura de caudal.  
 B) Conecte el alambre PE.  
 C) Conecte la alimentación.  
 D) Conecte el cable de salida.  
**Abrazadera de cable suministrada con el módulo bus, requerida únicamente para cables de comunicación por bus.**

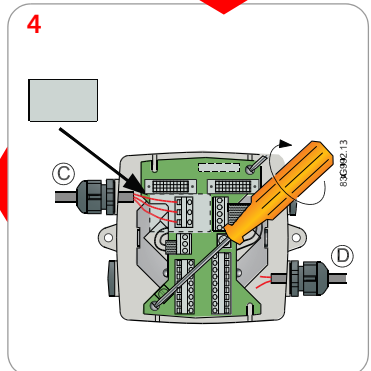
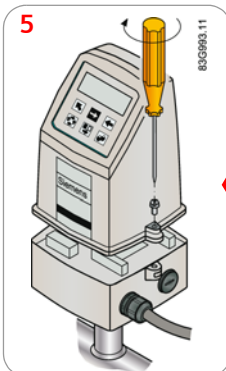
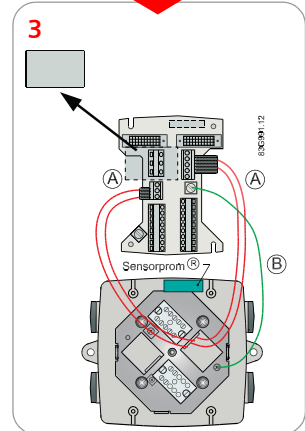
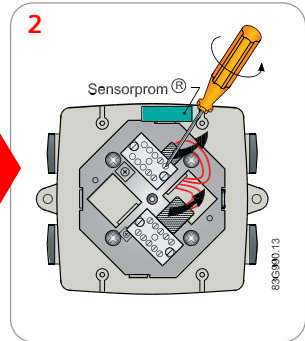
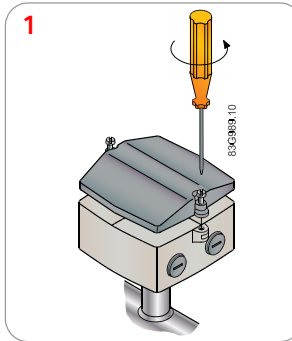

## MAG 5000/MAG 6000

(EN) Remote installation

(DE) Getrennte Montage

(FR) Montage séparé

(ES) Instalación remota

(EN) Ensure power is off before installation!

Relocate Sensorprom as shown.

- Connect electrode cable.
  - Connect coil cable, keep separate from A.
  - Connect power supply.
  - Connect output cable.
  - Connect PE (ground) wire.
- Cable clamp, see p. 3.

**Warning!**

- ⚠ PE wire must be connected to PE terminal. Coil cable shield must be connected to SHIELD terminal. Insulate core shield.

(DE) Prüfen Sie vor dem Einbau, ob das Gerät stromlos ist!

Sensorprom wie abgebildet umsetzen.

- Elektrodenkabel anschließen.
  - Spulenkabel anschließen, getrennt von A halten.
  - Stromversorgung anschließen.
  - Ausgangskabel anschließen.
  - PE-Schutzleiter anschließen.
- Kabelklemme, siehe S. 3.

**Warnung!**

- ⚠ PE-Draht an PE-Klemme anschliessen. Spulenkabel-Abschirmung an Schirmanschluss anschliessen. Schirm isolieren.

(FR) Vérifier que le système soit hors tension avant de l'installer!

Déplacer le Sensorprom tel qu'illustré.

- Connecter le câble d'électrode.
  - Connecter le câble de bobine, éloigner de A.
  - Connecter l'alimentation.
  - Connecter le câble de sortie.
  - Connecter le conducteur de protection PE.
- Serre-câble, voir p. 3.

**Avertissement!**

- ⚠ Le fil de masse doit être raccordé à la vis de masse. La tresse de masse du câble des bobines doit être raccordée comme indiqué sur le schéma isoler la tresse de masse.

(ES) ¡Cerciórese de que la alimentación está apagada antes de la instalación!

Cambie de lugar el Sensorprom tal como es mostrado.

- Conecte el cable del electrodo.
  - Conecte el cable de la bobina, y manténgala separada de A.
  - Conecte la alimentación.
  - Conecte el cable de salida.
  - Conecte el alambre PE.
- Abrazadera de cable, ver p. 3.

**Advertencia!**

- ⚠ El cable de tierra debe de ser conectado al terminal PE. La pantalla de la manguera de la bobina debe de ser conectada al terminal de pantalla. Aíse la pantalla principal.

Sensor  
Messaufnehmer  
Capteur  
Sensor

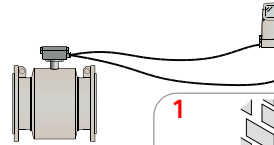

Transmitter  
Messumformer  
Transmetteur  
Transmisor

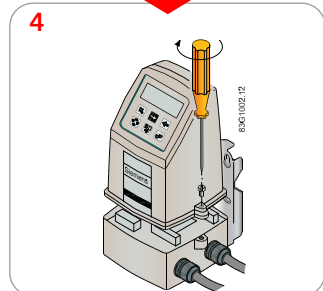
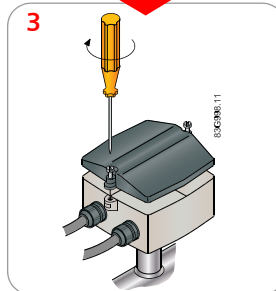
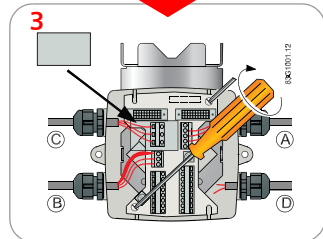
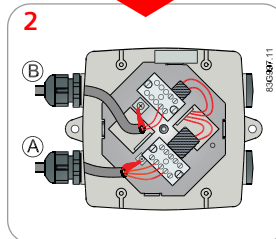
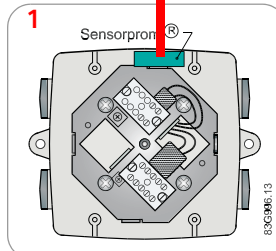
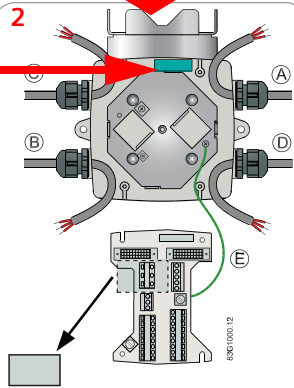
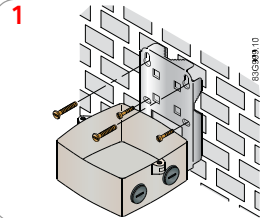



## MAG 6000 19"

(EN) Remote installation

(DE) Getrennte Montage

(FR) Montage séparé

(ES) Instalación remota

Sensor  
Messaufnehmer  
Capteur  
Sensor

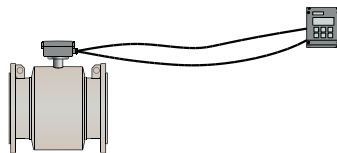

Transmitter  
Messumformer  
Transmetteur  
Transmisor

(EN) Ensure power is off before installation!

- A) Connect electrode cable.  
B) Connect coil cable, keep separate from A.

For transmitter cabling, see operating instructions on CD-ROM.

(DE) Prüfen Sie vor dem Einbau, ob das Gerät stromlos ist!

- A) Elektrodenkabel anschließen.  
B) Spulenkabel anschließen, getrennt von A halten.

Angaben zur Verdrahtung des Messumformers finden Sie auf der Betriebsanleitung auf der CD-ROM.

(FR) Vérifier que le système soit hors tension avant de l'installer!

- A) Connecter le câble d'électrode.  
B) Connecter le câble de bobine, éloigner de A.

Pour le raccordement du transmetteur consulter le manuel sur le CD-ROM.

(ES) ¡Cerciórese de que la alimentación está apagada antes de la instalación!

- A) Conecte el cable del electrodo.  
B) Conecte el cable de la bobina, y man téngala separada de A.

Para el cableado del transmisor, vea el manual en el CD ROM.

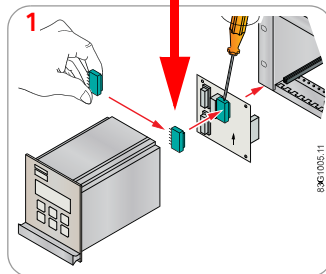
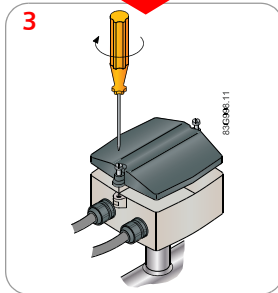
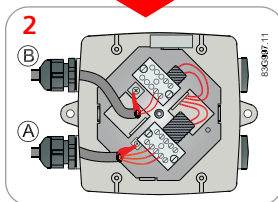
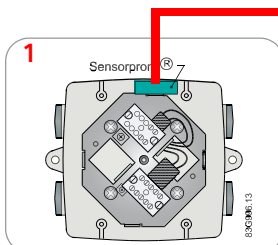

## EN Electrical Connection

### Power supply

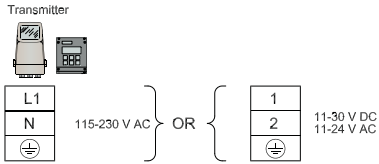

### Outputs

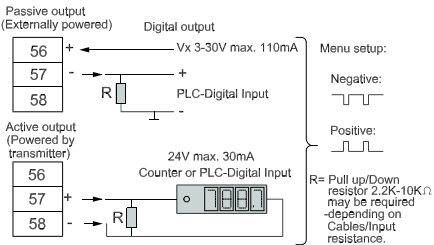
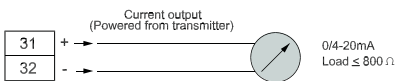

### Relay output

44	No	Relay
45	Nc	24 V DC/1A 42 V AC/2A
46	Common	

### Digital input

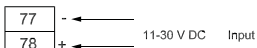

### Sensor connection

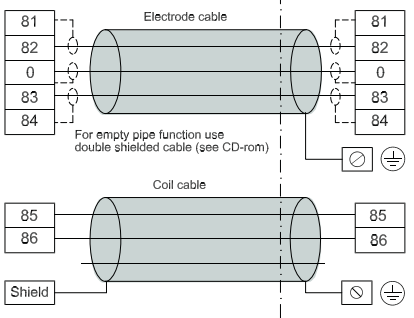

## DE Elektrischer Anschluss

### Stromversorgung

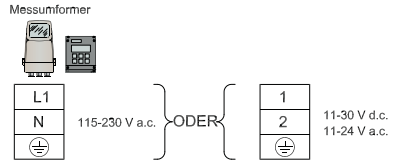

### Ausgänge

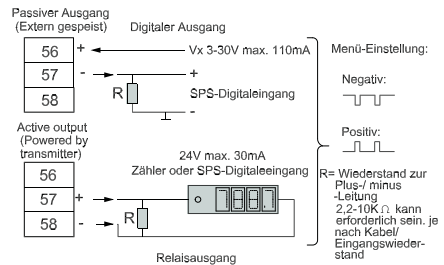
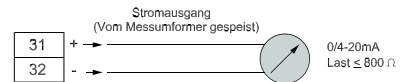

### Relaisausgang

44	No	Relais
45	Nc	24 Vdc/1 A 42 VAc/2 A
46	Common	= Gemeinsam

### Digitaleingang

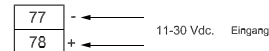

### Messaufnehmer-Anschluss

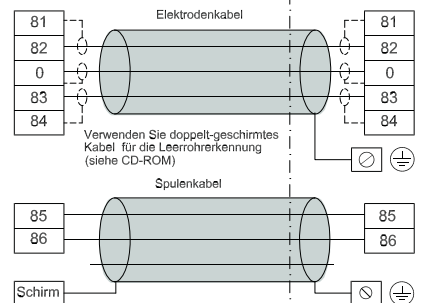

**FR** Raccordement électrique

**Alimentation**

Convertisseur de signaux

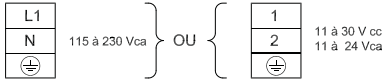

83C994.11-10.04

**Sorties**

Sortie de courant  
(Alimentée par le convertisseur de signaux)

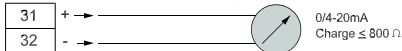

Sortie passive  
(Alimentée de l'extérieur)

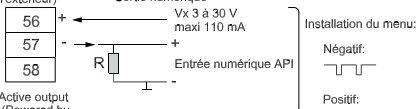

Active output  
(Powered by transmitter)

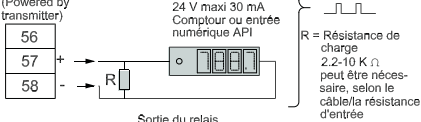

Sortie du relais

44	No	Relais
45	Nc	24 Vcc/1 A
46	Commun	42 Vca/2 A

**Entrée numérique**



**Raccordement tête de mesure**

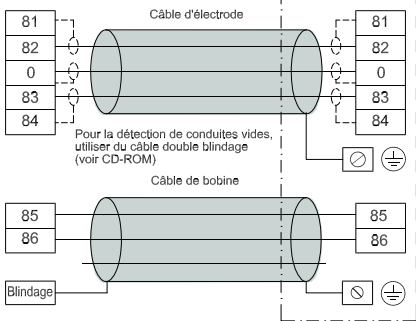

**ES** Conexiones eléctricas

**Alimentación**

Conversor de señal

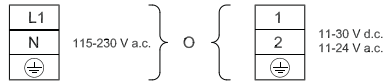

83C994.11-10.05

**Salidas**

Salida de corriente  
(alimentada desde convertidor)

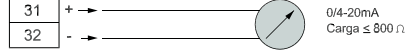

Salida pasiva  
(Alimentación externa)

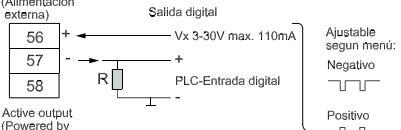

Active output  
(Powered by transmitter)

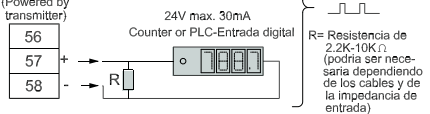

Salida de relé

44	No	Relé
45	Nc	24 V d.c./1A
46	Comun	42 V a.c./2A

**Entrada digital**

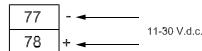

**Conexiones de sensor**

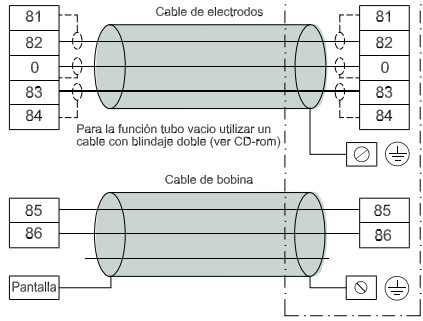



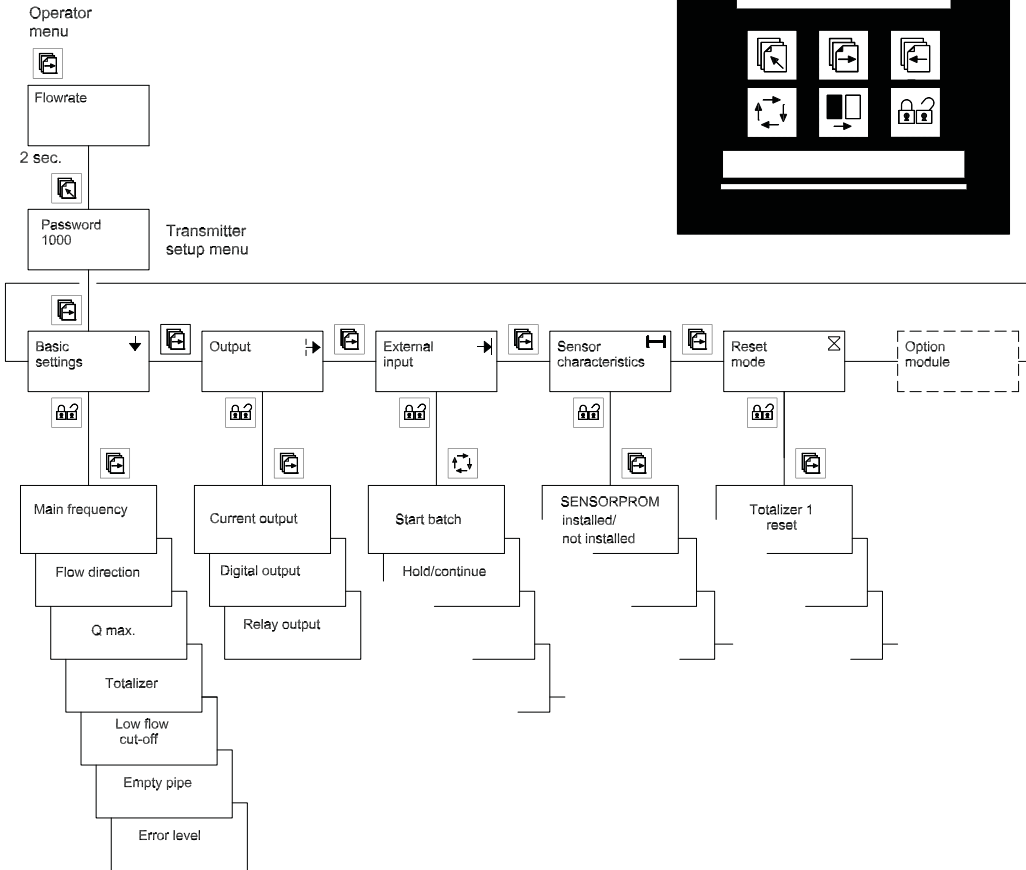



## EN Commissioning



83N28.10



For detailed settings please refer to the operating instructions on the enclosed CD-ROM.

- TOP UP KEY  This key (hold 2 sec.) is used to switch between operator menu and setup menu. In the transmitter setup menu, a short press will cause a return from a submenu
- PAGE FORWARD KEY  This key is used to step forwards through the menus.
- PAGE BACK KEY  This key is used to step backwards through the menus.
- CHANGE KEY  This key changes the settings or numerical values.
- SELECT KEY  This key selects the figures to be changed.
- LOCK/UNLOCK KEY  Process activation

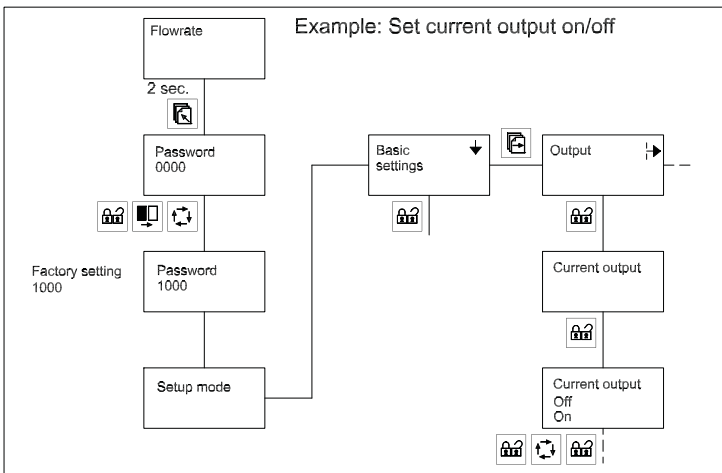
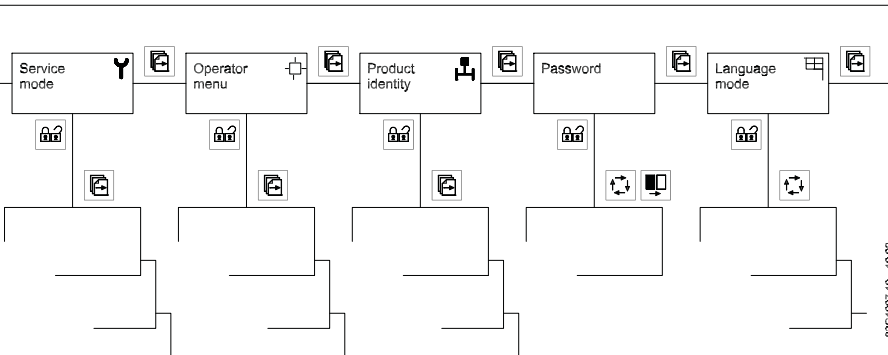

## DE Inbetriebnahme

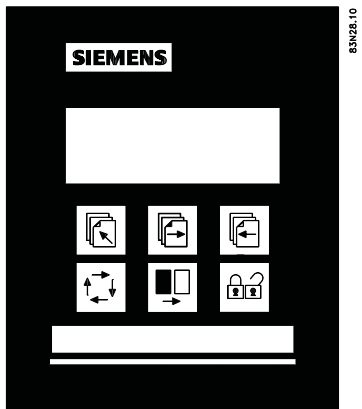
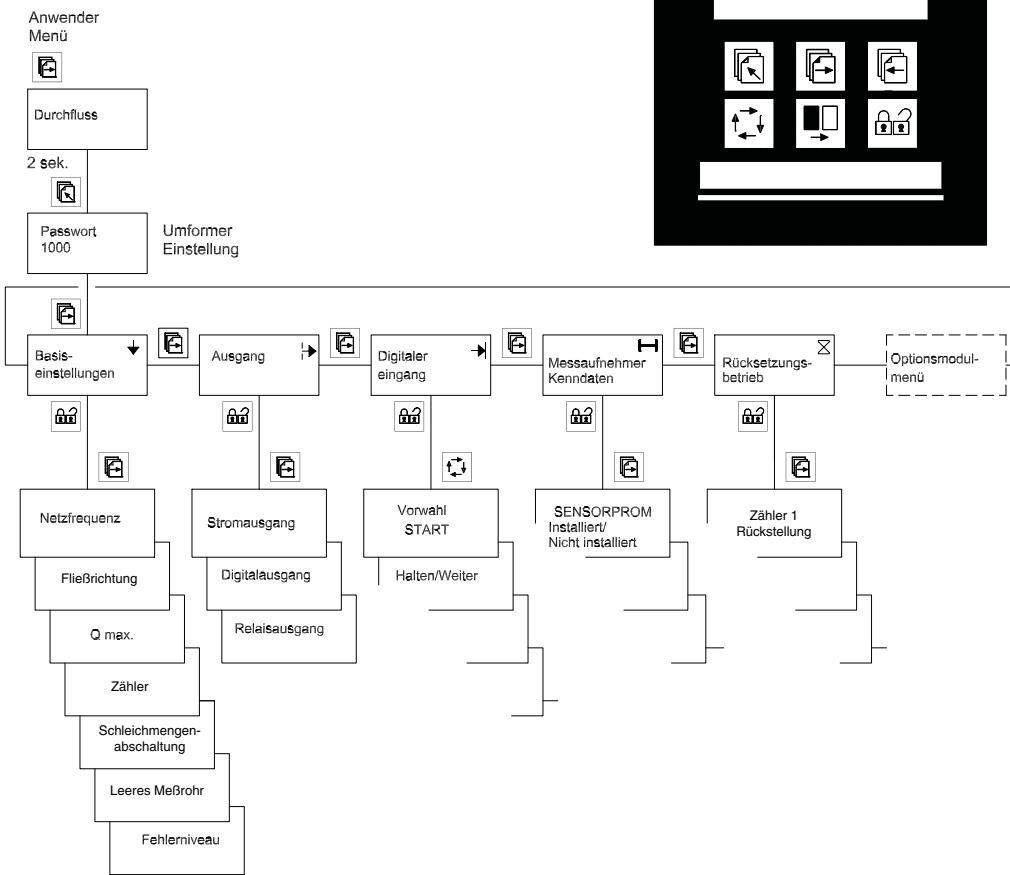

Genauere Angaben zu den Einstellungen siehe Betriebsanleitung auf der beigelegten CD-ROM.

GRUNDSTELLUNG



Diese Taste bitte 2 Sek. drücken um zwischen Anzeigemenu und Einstellmenü zu wechseln. Ein kurzes Antippen dieser Taste im Einstellmenü wechselt von einem Untermenü zurück.

BILD VORWÄRTS



Mit Hilfe dieser Pfeiltaste bewegt man sich in einem Menü von einem Menüpunkt zum Nächsten.

BILD ZURÜCK



Mit Hilfe dieser Pfeiltaste bewegt man sich in einem Menü zurück zum vorigen Menüpunkt.

ÄNDERUNG



Durch Drücken dieser Taste werden Einstellungen, Zahlenwerte und Einheiten geändert

AUSWAHL



Durch Drücken dieser Taste werden zu ändernde Werte ausgewählt

SPERREN/ENTSPERREN



Durch Drücken dieser Taste werden zu ändernde Einstellugen entsperrt, neue Werte gespeichert und Untermenüs aufgerufen

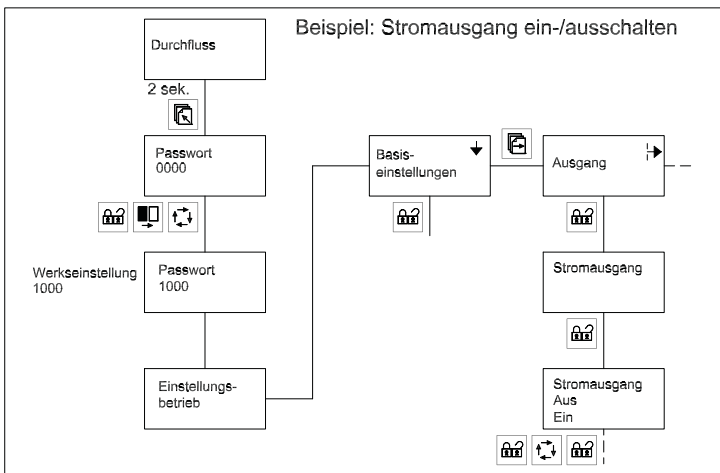
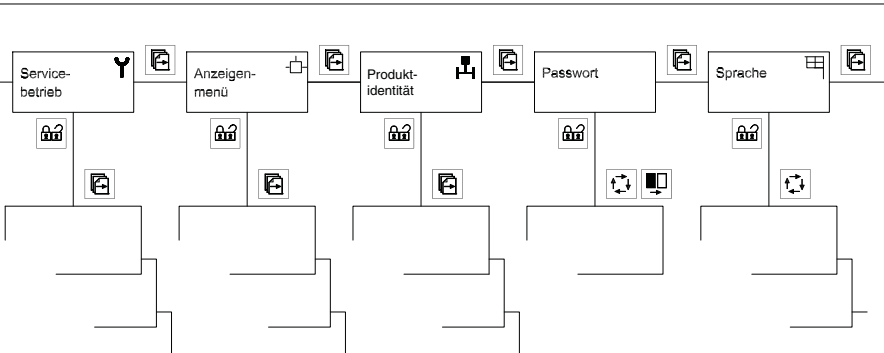



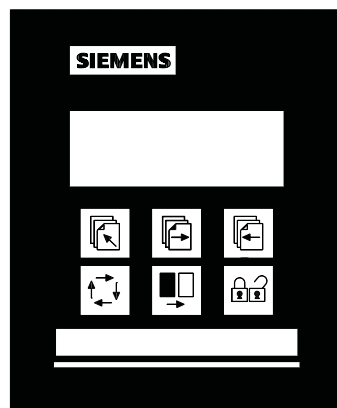
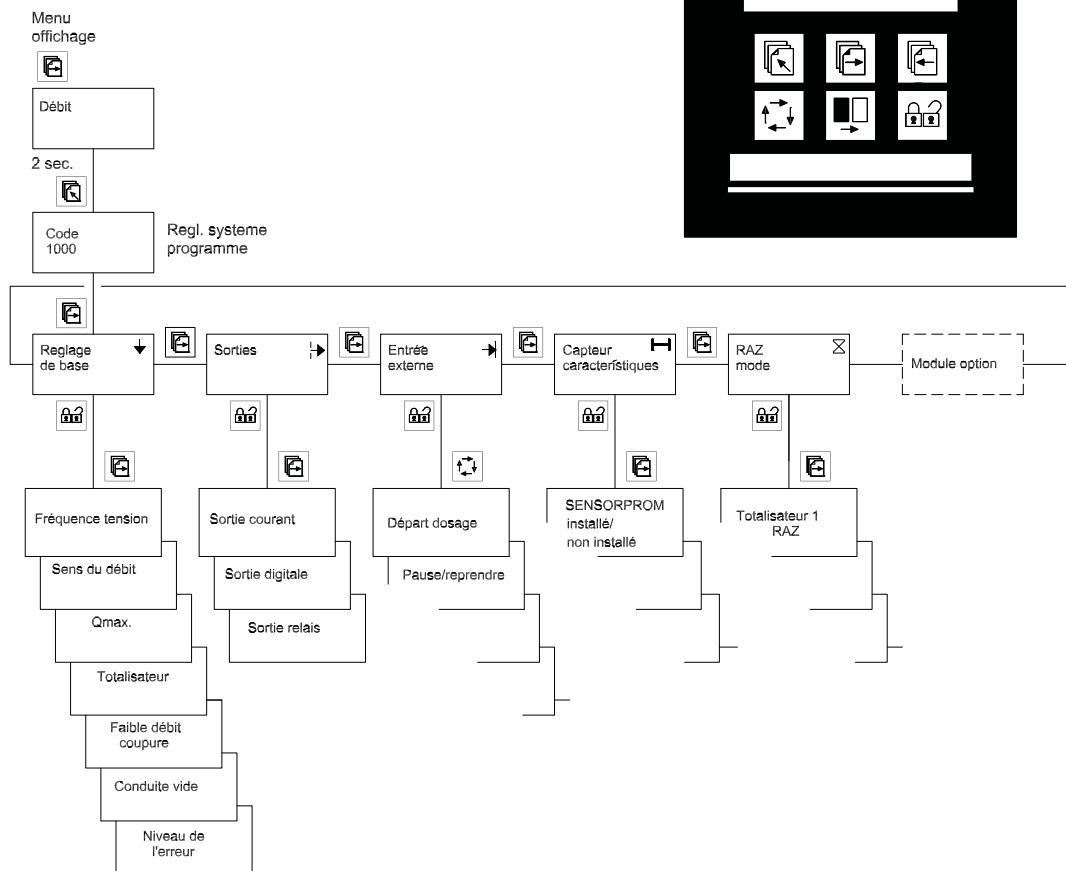



## FR Mise en service



 Pour plus de détails sur les réglages consulter les instructions de service sur le CD-ROM fourni.



- TOUCHE DEBUT  Cette touche (maintenir 2 sec.) permet de basculer du menu affichage au menu réglage. Dans le menu réglage, une impulsion peut entraîner le retour au sous-menu
- TOUCHE DEFILEMENT AVANT  Défilement des menus vers l'avant. Seule touche normalement utilisée par l'opérateur.
- TOUCHE DEFILEMENT ARRIERE  Défilement des menus vers l'arrière.
- TOUCHE MODIFICATION  Modification des réglages ou des valeurs numériques.
- TOUCHE SELECTION  Sélection des valeurs à modifier.
- TOUCHE VERROUILLAGE/ DEVEROUILLAGE  Activation process

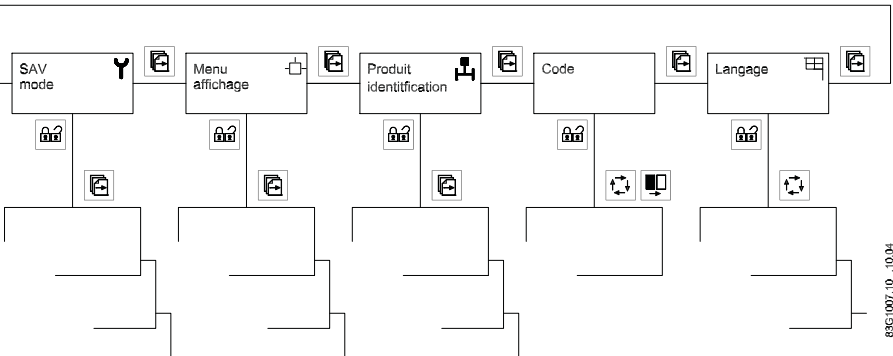



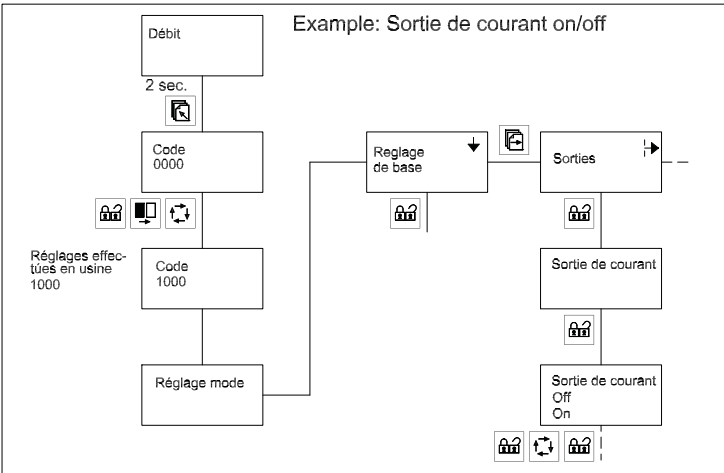

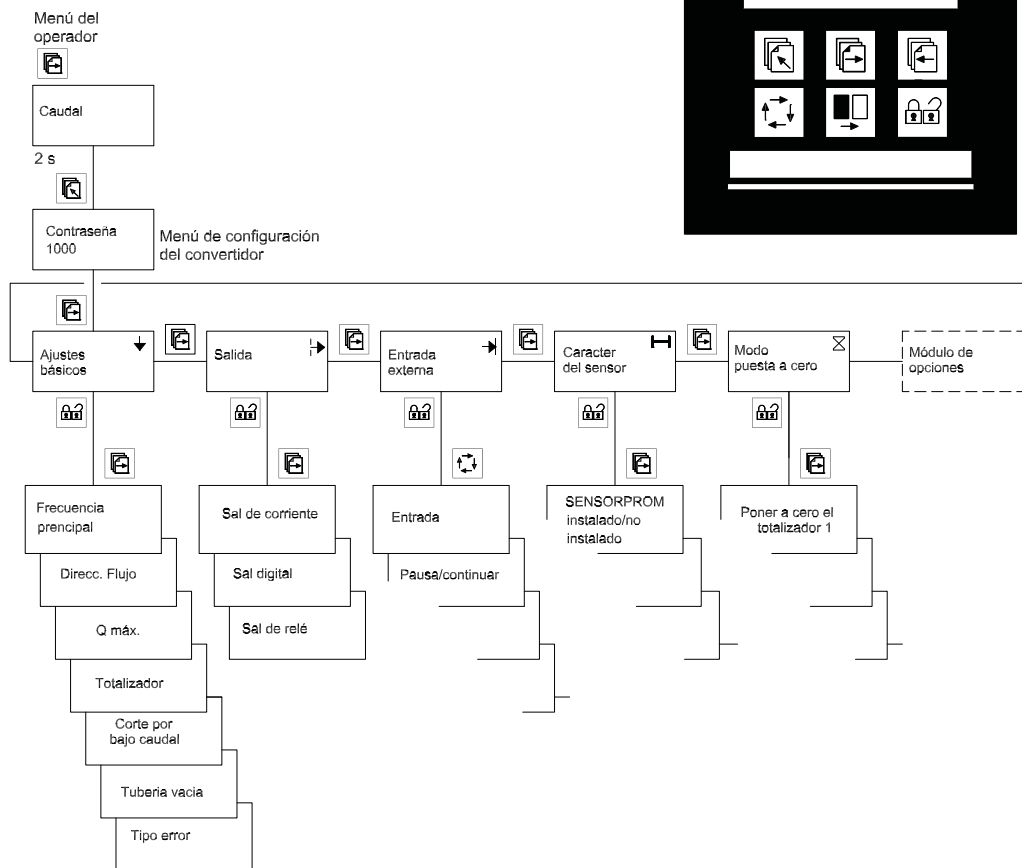

89G1007.10 -10.14



## ES Puesta en marcha



Para los ajustes detallados ver los instrucciones de servicio en el CD-ROM.

- Tecla FLECHA ARRIBA  Esta tecla (manteniéndola pulsada 2s) se utiliza para cambiar entre el menú del operador y el menú de configuración. En el menú de configuración del convertidor, una pulsación breve hace volver desde un submenú.
- Tecla AVANZAR PÁGINA  Esta tecla se utiliza para avanzar por los menús.
- Tecla RETROCEDER PÁGINA  Esta tecla se utiliza para retroceder por los menús.
- Tecla CAMBIAR  Esta tecla cambia los ajustes o valores numéricos.
- Tecla SELECCIONAR  Esta tecla selecciona los valores que se desea cambiar.
- Tecla BLOQUEAR/DESBLOQUEAR  Activación del proceso.

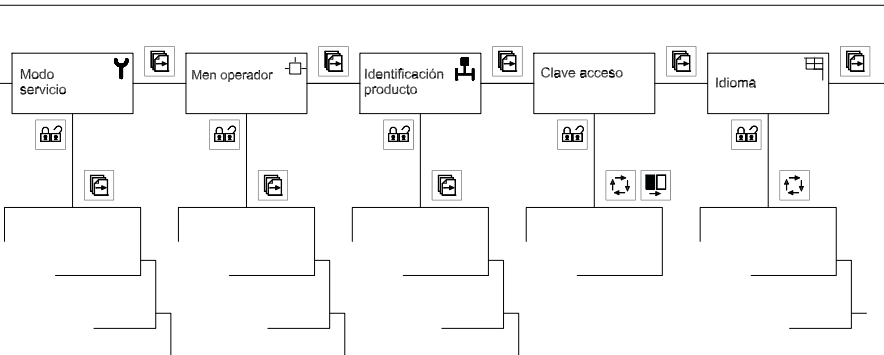

89G1007.10\_10.06

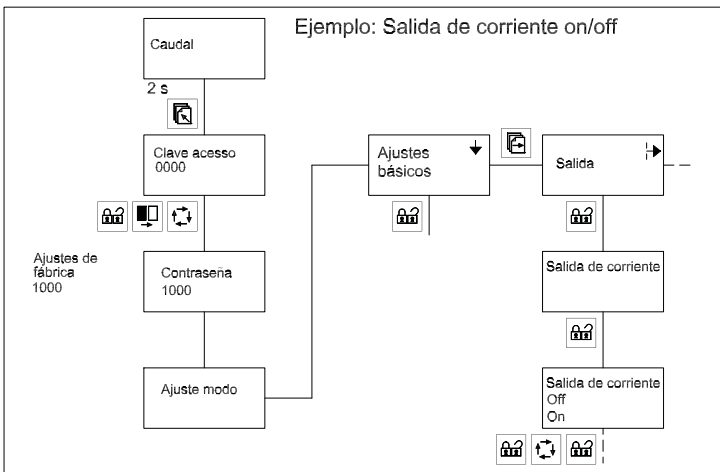

# SITRANS F M MAG 5000 & MAG 6000 IP 67, 19"



Siemens Flow Instruments A/S  
6430 NORDBORG  
DENMARK  
[www.siemens.com/flowdocumentation](http://www.siemens.com/flowdocumentation)

Order no.: A5E01222827-07  
Literature no.: SFIDK.PQ.027.A7.83

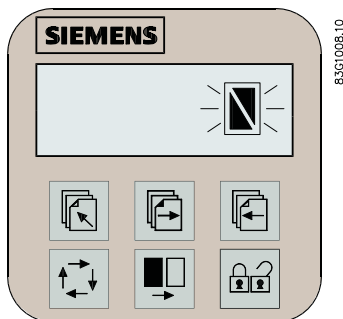

83G1008.10



**(EN)** We have reviewed the contents of this publication to ensure consistency with the hardware and software described. Since variance cannot be precluded entirely, we cannot guarantee full consistency. However, the information in this publication is reviewed regularly and any necessary corrections are included in subsequent editions. Responsibility for suitability and intended use of this instrument rests solely with the user.  
Copyright © Siemens AG 10.2009 All Rights Reserved. Technical data subject to change without prior notice.

**(DE)** Wir haben den Inhalt der Druckschrift auf Übereinstimmung mit der beschriebenen Hard- und Software geprüft. Dennoch können Abweichungen nicht ausgeschlossen werden, so dass wir für die vollständige Übereinstimmung keine Gewähr übernehmen. Die Angaben in dieser Druckschrift werden regelmäßig überprüft, notwendige Korrekturen sind in den nachfolgenden Auflagen enthalten. Der Benutzer ist allein verantwortlich für Eignung und Bestimmungszweck dieses Gerätes.  
Copyright © Siemens AG 10.2009 All Rights Reserved. Änderungen vorbehalten.

**(FR)** Nous avons vérifié la conformité du contenu du présent document avec le matériel et le logiciel qui y sont décrits. Ne pouvant toutefois exclure toute divergence, nous ne pouvons pas nous porter garants de la conformité intégrale. Si l'usage de ce manuel devait révéler des erreurs, nous en tiendrons compte et apporterons les corrections nécessaires dès la prochaine édition. La responsabilité concernant l'usage approprié et prévu de l'instrument incombe à l'utilisateur.  
Copyright © Siemens AG 10.2009 All Rights Reserved. Sous réserve de modifications techniques.

**(ES)** Hemos comprobado la concordancia del contenido de esta publicación con el hardware y el software descritos. Sin embargo, como es imposible excluir desviaciones, no podemos hacernos responsable de la plena concordancia. El contenido de esta publicación se revisa periódicamente; si es necesario, las posibles las correcciones se incluyen en la siguiente edición. La responsabilidad relativa a la conveniencia y al uso propuesto de este instrumento es exclusivamente del usuario.  
Copyright © Siemens AG 10.2009 All Rights Reserved. Sujeto a cambios sin previo aviso.