

# Coriolis flowmeters

SITRANS F C MASS 2100 Di 3-40

Operating Instructions • 07/2010



SITRANS F

**SIEMENS**



# SIEMENS

## SITRANS F

### Coriolis Flowmeters SITRANS F C MASS 2100 Di 3-40

#### Operating Instructions

<u>Introduction</u>	<b>1</b>
<u>Safety notes</u>	<b>2</b>
<u>Description</u>	<b>3</b>
<u>Installing/Mounting</u>	<b>4</b>
<u>Connecting</u>	<b>5</b>
<u>Commissioning</u>	<b>6</b>
<u>Service and maintenance</u>	<b>7</b>
<u>Technical data</u>	<b>8</b>
<u>Appendix</u>	<b>A</b>

Coriolis flow sensor type MASS 2100 Di 3, 6, 15, 25 or 40 designed for use with transmitter types SITRANS F C MASS 6000 or SIFLOW FC070

## Legal information

### Warning notice system

This manual contains notices you have to observe in order to ensure your personal safety, as well as to prevent damage to property. The notices referring to your personal safety are highlighted in the manual by a safety alert symbol, notices referring only to property damage have no safety alert symbol. These notices shown below are graded according to the degree of danger.

<b>⚠ DANGER</b>
indicates that death or severe personal injury <b>will</b> result if proper precautions are not taken.
<b>⚠ WARNING</b>
indicates that death or severe personal injury <b>may</b> result if proper precautions are not taken.
<b>⚠ CAUTION</b>
with a safety alert symbol, indicates that minor personal injury can result if proper precautions are not taken.
<b>CAUTION</b>
without a safety alert symbol, indicates that property damage can result if proper precautions are not taken.
<b>NOTICE</b>
indicates that an unintended result or situation can occur if the corresponding information is not taken into account.

If more than one degree of danger is present, the warning notice representing the highest degree of danger will be used. A notice warning of injury to persons with a safety alert symbol may also include a warning relating to property damage.

### Qualified Personnel

The product/system described in this documentation may be operated only by **personnel qualified** for the specific task in accordance with the relevant documentation for the specific task, in particular its warning notices and safety instructions. Qualified personnel are those who, based on their training and experience, are capable of identifying risks and avoiding potential hazards when working with these products/systems.

### Proper use of Siemens products

Note the following:

<b>⚠ WARNING</b>
Siemens products may only be used for the applications described in the catalog and in the relevant technical documentation. If products and components from other manufacturers are used, these must be recommended or approved by Siemens. Proper transport, storage, installation, assembly, commissioning, operation and maintenance are required to ensure that the products operate safely and without any problems. The permissible ambient conditions must be adhered to. The information in the relevant documentation must be observed.

### Trademarks

All names identified by ® are registered trademarks of the Siemens AG. The remaining trademarks in this publication may be trademarks whose use by third parties for their own purposes could violate the rights of the owner.

### Disclaimer of Liability

We have reviewed the contents of this publication to ensure consistency with the hardware and software described. Since variance cannot be precluded entirely, we cannot guarantee full consistency. However, the information in this publication is reviewed regularly and any necessary corrections are included in subsequent editions.

# Table of contents

<b>1</b>	<b>Introduction.....</b>	<b>5</b>
1.1	Items supplied .....	5
1.2	History .....	6
1.3	Further Information .....	6
<b>2</b>	<b>Safety notes.....</b>	<b>9</b>
2.1	Laws and directives .....	9
2.2	Installation in hazardous area .....	10
<b>3</b>	<b>Description.....</b>	<b>13</b>
3.1	Design .....	13
3.2	Theory of operation.....	15
<b>4</b>	<b>Installing/Mounting.....</b>	<b>17</b>
4.1	Installation safety precautions.....	17
4.2	Determining a location .....	18
4.3	Orienting the sensor.....	19
4.4	Mounting the sensor .....	21
4.5	Mounting a pressure guard .....	22
<b>5</b>	<b>Connecting .....</b>	<b>23</b>
5.1	Safety precautions .....	23
5.2	Wiring .....	24
5.3	Turning the terminal box .....	25
<b>6</b>	<b>Commissioning .....</b>	<b>27</b>
6.1	Zero point adjustment .....	27
<b>7</b>	<b>Service and maintenance .....</b>	<b>29</b>
7.1	Maintenance.....	29
7.2	Transportation/storage.....	29
7.3	Recalibration .....	29
7.4	Unit repair.....	30
7.5	Technical support.....	30
7.6	Return procedures .....	31
<b>8</b>	<b>Technical data .....</b>	<b>33</b>
8.1	Technical specifications .....	33
8.2	Measurement range.....	34

Table of contents

---

8.3	Accuracy specifications.....	35
8.4	Pressure drop.....	36
8.5	Pressure / temperature range .....	38
8.6	Electrical connection schematics .....	41
8.7	Dimensions and weight .....	42
<b>A</b>	<b>Appendix.....</b>	<b>47</b>
A.1	Ordering .....	47
	<b>Glossary .....</b>	<b>49</b>
	<b>Index.....</b>	<b>53</b>

# Introduction

These instructions contain all the information you need for using the device.

The instructions are aimed at persons mechanically installing the device, connecting it electronically, configuring the parameters and commissioning it as well as service and maintenance engineers.

---

## Note

It is the responsibility of the customer that the instructions and directions provided in the manual are read, understood and followed by the relevant personnel before installing the device.

---

## 1.1 Items supplied

- MASS 2100 sensor
- Sensorprom
- Calibration report
- Quick Start
- SITRANS F technical literature CD-ROM

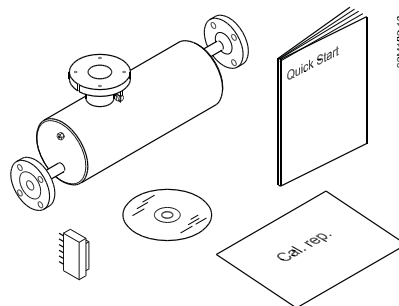

## Inspection

1. Check for visual mechanical damage due to possible improper handling during shipment. All claims for damage are to be made promptly to the carrier.
2. Make sure the scope of delivery, and the information on the type plate corresponds to your order and the delivery note.

Identification

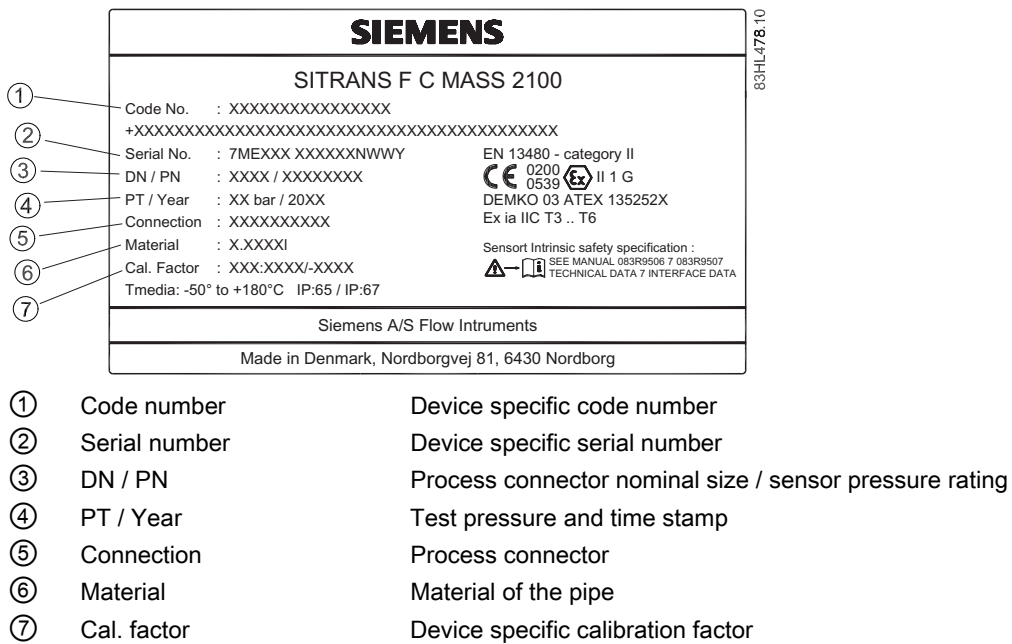

Figure 1-1 MASS 2100 Type plate

1.2 History

The contents of these instructions are regularly reviewed and corrections are included in subsequent editions. We welcome all suggestions for improvement.

The following table shows the most important changes in the documentation compared to each previous edition.

Edition	Remarks
07/2010	First edition of Operating Instructions for SITRANS F C MASS 2100 DN 3-40. The document replaces all previous Instructions for use.

1.3 Further Information

The contents of these Operating Instructions shall not become part of or modify any prior or existing agreement, commitment or legal relationship. All obligations on the part of Siemens AG are contained in the respective sales contract which also contains the complete and solely applicable warranty conditions. Any statements contained herein do not create new warranties or modify the existing warranty.



### Product information on the Internet

The Operating Instructions are available on the CD-ROM shipped with the device, and on the Internet on the Siemens homepage, where further information on the range of SITRANS F flowmeters may also be found:

Product information on the internet (<http://www.siemens.com/flowdocumentation>)

### Worldwide contact person

If you need more information or have particular problems not covered sufficiently by the operating instructions, please get in touch with your contact person. You can find contact information for your local contact person on the Internet:

Local contact person (<http://www.automation.siemens.com/partner>)

### See also

Technical support (Page 30)



 <b>CAUTION</b>
Correct, reliable operation of the product requires proper transport, storage, positioning and assembly as well as careful operation and maintenance. Only qualified personnel should install or operate this instrument.

---

**Note**

Alterations to the product, including opening or improper repairs of the product, are not permitted.

If this requirement is not observed, the CE mark and the manufacturer's warranty will expire.

---

## 2.1 Laws and directives

### General requirements

Installation of the equipment must comply with national regulations. For example EN 60079-14 for the European Community.

### Instrument safety standards

The device has been tested at the factory, based on the safety requirements. In order to maintain this condition over the expected life of the device the requirements described in these Operating Instructions must be observed.

<b>CAUTION</b>
<b>Material compatibility</b>
Siemens Flow Instruments can provide assistance with the selection of wetted sensor parts. However, the full responsibility for the selection rests with the customer and Siemens Flow Instruments can take no responsibility for any failure due to material incompatibility.

### CE marked equipment

The CE-mark symbolizes the compliance of the device with the following guidelines:

- EMC-directive 2004/108/EC
- Low voltage directive 2006/95/EC

2.2 Installation in hazardous area

- Pressure equipment directive (PED/DGRL) 93/23/EC
- ATEX Directive 94/9/EC

## 2.2 Installation in hazardous area

 <b>WARNING</b>
Equipment used in hazardous areas must be Ex-approved and marked accordingly. It is required that the special conditions for safe use provided in the manual and in the Ex certificate are followed!

### Hazardous area approvals

The device is approved for use in hazardous area and has the following approval:

- II 1G EEx ia IIC T3-T6

 <b>WARNING</b>
Make sure the hazardous area approval is suitable for the environment in which the device is installed.
<ul style="list-style-type: none"> <li>• SITRANS F C MASS 6000 Ex d is approved for use in hazardous area.</li> <li>• SITRANS F C MASS 6000 19" Ex (IP65) is approved for Class I Div 2 and Zone 2.</li> <li>• SIFLOW FC070 Ex is approved for use in Zone 2.</li> </ul>

### Intrinsically safe data

Table 2- 1 Sensor circuit

Sensor circuit (Terminal 1-2)	Di3	Di6	Di15	Di25	Di40
Ui	16V	16V	16V	16V	16V
Ii	0.132A	0.132A	0.132A	0.132A	0.132A
Pi	0.75W	0.75W	0.75W	0.75W	0.75W
Li or Li/Ri	0.5mH or 80[μH/Ω]	1.5mH or 40[μH/Ω]	30[μH/Ω]	1mH or 10[μH/Ω]	15[μH/Ω]
Ci	50pF	50pF	50pF	50pF	50pF

Table 2- 2 Temperature sensor circuit

Temperature sensor (Terminals 3,4 & 9)	
Ui	15V
Ii	8mA
Pi	0.03W
Li	Insignificant
Ci	50pF

Table 2- 3 Pickup driver circuit

Pickup driver (Terminals 5-6 & 7-8)	
Ui	15V
Ii	15mA
Pi	0.056W
Li	0.5mH
Ci	50pF

 WARNING
With intrinsically safe circuits, use only certified transmitters appropriate for the sensor. If a non-conforming supply unit is used, the "fail-safe" type of protection will no longer be effective and the approval certification will be invalid.

### Temperature specifications for Ex use

Temperature class	Ambient temperature [°C]	Process media temperature [°C]
T3	-20 ... +50	-50 ... +180
T4	-20 ... +50	-50 ... +125
T5	-20 ... +50	-50 ... +90
T6	-20 ... +50	-50 ... +60

For ambient temperatures below -10°C and above +60°C use field wiring suitable for both minimum and maximum ambient temperature.

### Hazardous area safety requirements

It is required that:

- Electrical connections are in accordance with national directives such as IEC/EN60079-14 (Installing Electrical Systems in Explosion Hazardous Areas).
- Sensor and transmitter are connected to the potential equalization.

 <b>WARNING</b>
--------------------------------------------------------------------------------------------------

<b>Laying of cables</b>
-------------------------

Cable for use in zone 1 and 2 or 21 and 22 must satisfy the requirements for having a proof voltage AC 500 V applied between the conductor/ground, conductor/shield and shield/ground.
----------------------------------------------------------------------------------------------------------------------------------------------------------------------------------------

## Description

### Measurement of liquids and gases

SITRANS F C Coriolis mass flow meters are designed for measurement of a variety of liquids and gases. The meters are multi parameter devices offering accurate measurement of mass flow, volume flow, density, fraction, Brix/Plato, and temperature.

### Main applications

The main applications of the Coriolis flow meter can be found in all industries, such as:

- Chemical & Pharma: Detergents, bulk chemicals, pharmaceuticals, acids, alkalis
- Food & Beverage: Dairy products, beer, wine, softdrinks, plato/brix, fruit juices and pulps, bottling, CO<sub>2</sub> dosing, CIP/SIP-liquids
- Automotive: Fuel injection, nozzle & pump testing, filling of AC units, engine consumption, paint robots
- Oil & Gas: Filling of gas bottles, furnace control, CNG-dispensers, test separators
- Water & Waste Water: Dosing of chemicals for water treatment

## 3.1 Design

### Versions



MASS 2100 DI 3-40, remote version



MASS 2100 compact mounted with MASS 6000 IP67



MASS 2100 compact mounted with MASS 6000 Ex d

The MASS 2100 Di3-40 is designed for use with the whole range of SITRANS F C transmitters presently including MASS 6000 IP67, MASS 6000 19", MASS 6000 Ex d and Siflow FC070.

All transmitters are suitable for remote installation and the MASS 6000 IP67 and MASS 6000 Ex d transmitters are also applicable for compact installations (mounted directly on the sensor). Regardless of transmitter version, the accuracy specification remains valid.

### Description

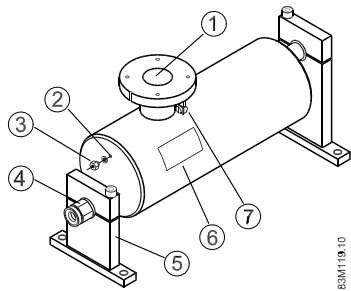

- ① Transmitter connection
- ② Threaded hole for e.g. pressure guard
- ③ Nipple
- ④ Process connector
- ⑤ Mounting bracket
- ⑥ Type plate
- ⑦ Earth terminal

Figure 3-1 Product description

### Design

The MASS 2100 sensor design is based on a single bent tube welded directly to the process connections at each end. The tube has a large internal diameter which reduces pressure loss and improves overall flow capacity. All Mass 2100 sensors come with an intrinsically safe Ex design.

The sensors are available in two material configurations (W1.4435, AISI 316L or W2.4602, Hastelloy C22). The enclosure is made of stainless steel W1.4301, AISI 316L with an encapsulation grade of IP67/NEMA 4.

Maximum immunity towards process noise is among many things obtained through the center block.

The sensors can be equipped with a pressure guard or flushed at the corresponding holes at the end of the sensor.



## Heating Jacket

MASS 2100, DI 3 to DI 40 can optionally be ordered with an integral heating coil to avoid solidification of sensitive fluids as e.g. chocolate or bitumen during down-time or periods between discontinuing processes. This feature gives the freedom to let e.g. hot water, superheated steam or hot oil maintain a constant temperature inside the sensor.

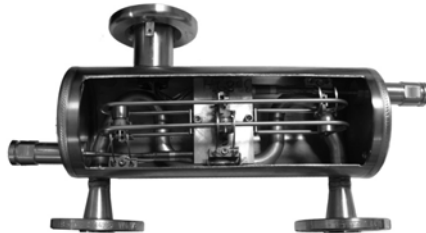
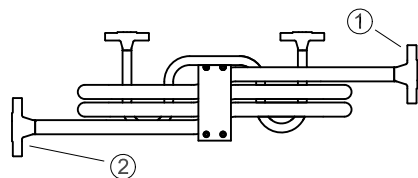

Figure 3-2 MASS 2100 heating jacket version cut-off



- ① integral heating connector
- ② Process connector

Figure 3-3 MASS 2100 heating jacket version

## 3.2 Theory of operation

The flow measuring principle is based on Coriolis law of movement.

The Sitrans F C sensors are energized by an electromechanical driver circuit which oscillates the pipe at its resonant frequency. Two pick-ups, 1 and 2 are placed symmetrically on both sides of the driver. When the media flows through the sensor, Coriolis force will act on the measuring tube and cause a tube deflection which can be measured as a phase shift between pick-up 1 and pick up 2.

The phase shift is proportional to the mass flow rate. The amplitude of the driver is automatically regulated via a "phase locked loop", to ensure a stable output from the 2 pickups in the region of 80 to 120 mV. The temperature of the sensor is measured by a Pt1000, in a 4-wire configuration.

The flow proportional signal from the 2 pick-ups, the temperature measurement and the driver frequency are fed into the transmitter for calculations of mass, density, volume, fraction, Brix/Plato, and temperature.

## **SENSORPROM**

All SITRANS F C Coriolis flow meters feature a SENSORPROM® memory unit which stores sensor specific calibration data and transmitter settings for the lifetime of the product. The factory settings matching the sensor are stored in the SENSORPROM® unit. At commissioning the flow meter commences measurement without any initial programming. Also customer specified settings are downloaded to the SENSORPROM® unit.

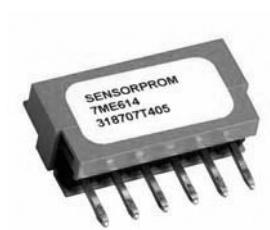
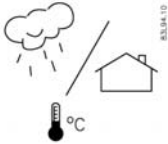

Figure 3-4 Sensorprom memory unit

## Installing/Mounting



SITRANS F flowmeters are suitable for in- and outdoor installations.

- Make sure that pressure and temperature specifications indicated on the device type plate / label will not be exceeded.

### **! WARNING**

#### **Installation in hazardous location**

Special requirements apply to the location and interconnection of sensor and transmitter. See "Installation in hazardous area" (Page 10)

### 4.1 Installation safety precautions

### **! WARNING**

In applications with working pressures/media that can be dangerous to people, surroundings, equipment or others in case of pipe fracture, we recommend that special precautions such as special placement, shielding or installation of a security guard or a security valve are taken when the sensor is mounted.

- Ensure that stresses and loading caused by e.g. earthquakes, traffic, high winds and fire damage if appropriate are taken into account during installation.
- Ensure that the flowmeter is installed such that it does not act as a focus for pipeline stresses. External loadings are not taken into account in the flowmeter design.
- Provide adequate protection to minimise any risk of contact with hot surfaces.

### **! WARNING**

Prevent personal injuries by assuring that operation below pressure guards cannot take place.

### **! WARNING**

The sensor enclosure is not rated for pressure containment.

## 4.2 Determining a location

 **CAUTION**

Do not install the sensor in the vicinity of strong electromagnetic fields, e.g. near motors, pumps, transformers etc.

### Upstream / downstream

- No pipe run requirements, i.e. straight inlet/outlet sections are not necessary.
- Avoid long drop lines downstream from the flow meter to prevent the meter tube from draining (min. back pressure: 0.2 Bar).
- Avoid installing the sensor immediately upstream of a free discharge in a drop line.

### Location in the system

The optimum location in the system depends on the application:

- **Liquid applications**  
For liquid applications the presence of gas or air bubbles in the fluid may result in erroneous measurements, particularly in the density measurement. Therefore do not install the flow meter at the highest point in the system, where gas / air bubbles will be trapped. For liquids it is advantageous to install the flow meter in low pipeline sections, at the bottom of a U-section in the pipeline.



Figure 4-1 Liquid applications

- **Gas applications**  
For gas applications the presence of oil may result in erroneous measurements. Therefore do not install the flow meter at the lowest point of the system, or install a filter.



Figure 4-2 Gas applications

## 4.3 Orienting the sensor

### Flow direction

The flow direction is indicated by the arrow on the sensor. Flow in this direction will be indicated as positive.

 <b>CAUTION</b>
The sensor must always be completely filled with process fluid in order to measure accurately.

### Orienting the sensor

MASS 2100 Di 3-40 operates in any orientation, but Siemens Flow Instruments recommends orienting the sensor according to application type:

1. Horizontal installation (optimum orientation)  
Especially suited for low flow applications: Solid particles will not be deposited in the tube and the sensor can easily be degassed.

<b>NOTICE</b>
<b>Self drainage</b> The flowmeter is self-draining if installed horizontally

2. Vertical installation with an upwards flow (only liquid applications).

### Liquid applications

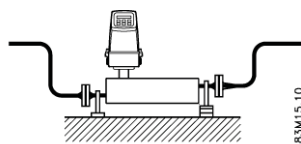

Horizontal installation, correct

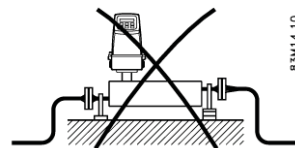

Horizontal installation, wrong

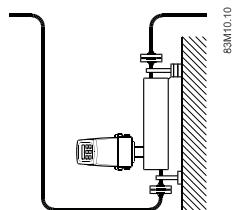

Vertical installation, correct

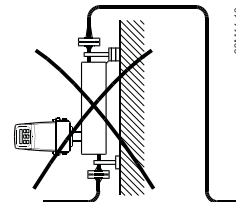

Vertical installation, wrong

Gas applications

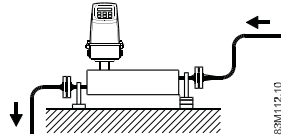

Horizontal installation

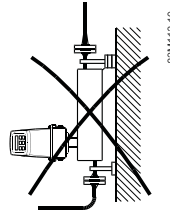

Vertical installation (not recommended)

Installation in a drop line

Installation in a dropline is only possible if a pipeline reduction or orifice with a smaller cross-section can be installed to prevent the sensor from being partially drained during the measurements.

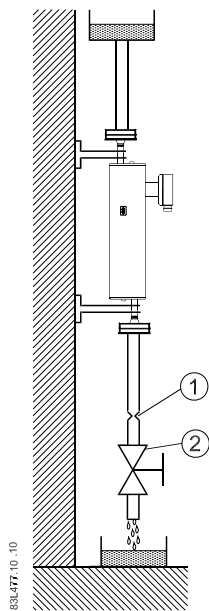

- ① Orifice Pipe
- ② Valve

Figure 4-3 Installation in drop line

## 4.4 Mounting the sensor

- Install the sensor in rigid pipelines in order to support the weight of the meter.
- Center the connecting pipelines axially in order to assure a stress-free installation.
- Install two supports or hangers symmetrically and stress free in close proximity to the process connections.  
Siemens Flow Instruments recommends installing the supports / hangers between sensor enclosure and process connections.

### Avoid vibrations

Use flexible hoses, if vibrations exist in the pipeline. The hoses must be installed outside the supported flow meter section and outside the section between the shut off devices. The direct connection of flexible elements to the sensor should be avoided.

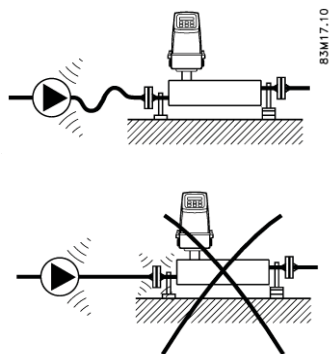

### Avoid crosstalk

Mount the sensors on separate steel frames, keep distance between the sensors, or decouple the pipelines, if operating more than one meter in one or multiple interconnected pipelines. This will prevent cross talk.

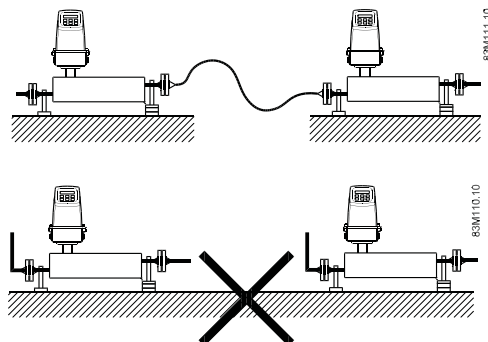

## 4.5 Mounting a pressure guard

The sensor enclosure is supplied with two 1/8" nipples. These holes can be used for e.g. a pressure guard, which can be connected to an automatic shut off valve which will stop the flow in case of sensor pipe fracture.

### Mounting of pressure guard

 **CAUTION**

**Avoid moisture, liquids or particles getting into the sensor enclosure**

All sensors are filled with argon to avoid condensation. Penetration of humidity, liquids or particles into the sensor may influence the measurement and in worst case affect the measuring function.

Install a pressure guard as follows:

1. Place the sensor in a dry, clean place and leave it to acclimatize until it reaches ambient temperature, preferred 20°C (68°F).
2. Carefully disconnect the nipple and mount the pressure guard. Use the enclosed spare part sealing ring for proper sealing.
3. Make sure that the pressure guard does NOT touch any of the parts inside the sensor.
4. Check that the pressure guard has been correctively mounted and thoroughly tightened. After dismantling the sealing ring must be replaced with a new sealing ring.

### See also

Pressure guards are not supplied with the sensor. For more information, please refer to [www.siemens.com/sitransp](http://www.siemens.com/sitransp) (<http://www.siemens.com/sitransp>)



The following contains a short description of how to connect a remote mounted sensor to the transmitter SITRANS F C MASS 6000 / SIFLOW FC070. For more information, including information about compact versions, refer to the Operating Instructions for the respective transmitters.

 **WARNING**

Only qualified personnel may carry out work on the electrical connections.

## Before connecting

- Check that serial numbers on sensor and SENSORPROM® unit are identical.

 **WARNING**

**Use in hazardous locations**

Before connecting check that:

- No explosion hazard exists
- A fire department permission certificate has been issued
- All connection leads are potential free

Special requirements apply to the location and interconnection of sensor and transmitter. See "Installation in hazardous area" (Page 10)

## 5.1 Safety precautions

 **WARNING**

**Mains supply from building installation Class II**

A switch or circuit breaker (Max. 15 A) must be installed in close proximity to the equipment and within easy reach of the operator. It must be marked as the disconnecting device for the equipment.

 **WARNING**

**Field wiring installation**

Ensure that the **National Installation Code** of the country in which the devices are installed is met.

## 5.2 Wiring

1. Connect transmitter and sensor using the screw connector on the blue cable supplied with the sensor.

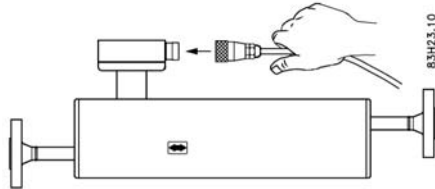

Figure 5-1 Sensor and transmitter connection

2. Connect grounding terminal ① to protective earth (PE).

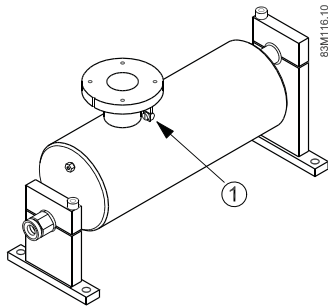

Figure 5-2 Grounding terminal

### NOTICE

#### Cable screen

Cable screen is connected to earth.

### ⚠ WARNING

Only commission the device after the device has been properly connected and, if required, closed.

### See also

Electrical connection schematics (Page 41)

## 5.3 Turning the terminal box

For remote versions, the adapter can optionally be oriented in four directions.

1. Loosen the four screws by use of an allen key and turn the adaptor.

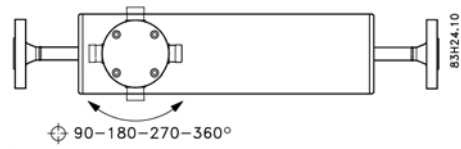

2. Tighten the screws and mount the multiple plug.



Before commissioning it must be checked that:

- The device has been installed and connected in accordance with the guidelines provided in chapter 4 "Installing / Mounting (Page 17)" and 5 "Connecting (Page 23)"
- Device installed in hazardous location meets the requirements described in "Installation in hazardous location (Page 10)"

## 6.1 Zero point adjustment

Performing a zero point adjustment establishes the reference point of the flowmeter at zero flow. All Coriolis sensors from Siemens are calibrated before they are sent out to customers. However, Coriolis sensors are very sensitive, and several factors might move the zero point, e.g. installation, pressure, temperature and even very small vibrations coming from the process. All these factors are customer specific and cannot be simulated at the factory. Therefore Siemens recommends carrying out a zero point adjustment before use to obtain optimum accuracy.

In the following it is described how to zero point adjust the device. For setting application specific parameters, please refer to the Operating Instructions of the relevant transmitter.

### Before zero point adjusting

- Install shut off devices in the pipeline, optimally both up- and downstream of the sensor, otherwise at the sensor outlet

Vertical

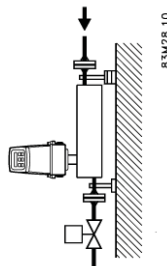

Horizontal

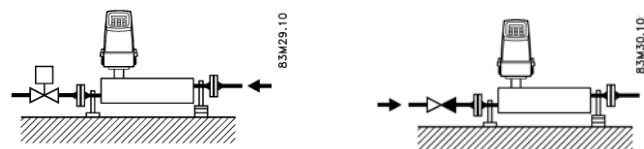

<b>CAUTION</b>
In order to avoid damaging the pump and interrupting the process it is recommended to install a bypass line

**Auto zero point adjustment**

- Power up the device and acclimate the transmitter (min. 30 min).
- Pump liquid at max. flow through the sensor (min. 2 min or until the driver signal and driver frequency are stable) in order to avoid air in the liquid.
- Stop the flow while pumping by shutting off the outlet valve and then the inlet valve. Wait min. 1 minute. In this way the liquid remain pressurized and any degassing is avoided.

---

**Note**

The flow must be completely stopped and the sensor completely filled with liquid.

---

- Perform an auto zero point adjustment:

<b>MASS 6000</b>	<b>SIFLOW FC070</b>
Choose menu entry "Reset mode" -> Zero adjust -> Zero adjust auto	Choose the SIMATIC PDM menu -> Device -> zero adjust

For further information on performing an auto zero point adjustment please refer to the relevant transmitter Operating Instructions.

- After count down (30 s.), the actual zero point is displayed and the meter ready for operation.

## Service and maintenance

### 7.1 Maintenance

The device is maintenance-free, however, a periodic inspection according pertinent directives and regulations must be carried out.

An inspection can include check of:

- Ambient conditions
- Seal integrity of the process connections, cable entries, and cover screws
- Reliability of power supply, lightning protection, and grounds

### 7.2 Transportation/storage

The sensor is a fragile piece of equipment. Impact and shock can cause measuring inaccuracy. Therefore during transportation it must be placed in the transportation box delivered by Siemens Flow Instruments. If this is not possible, the alternative sensor packaging must be able to withstand the hazards from transportation.



### 7.3 Recalibration

Siemens Flow Instruments offers to recalibrate the sensor. The following calibrations are offered as standard according to configuration (standard, density, brix/plato, fraction):

- Standard calibration
- Customer specified calibration (up to 10 points)
- Accredited calibration
- Matched pair calibration

---

**Note**

For recalibration the SENSORPROM memory unit must always be returned with the sensor

---

**See also**

Return procedures (Page 31)

## 7.4 Unit repair

<b>CAUTION</b>
Repair and service must be carried out by Siemens authorized personnel only.

Repair and service must be carried out by Siemens authorized personnel only.

---

**Note**

Siemens Flow Instruments defines sensors as non-repairable products.

---

## 7.5 Technical support

If you have any technical questions about the device described in these Operating Instructions and do not find the right answers, you can contact Technical Support:

- Via the Internet using the **Support Request:**  
Support request (<http://www.siemens.com/automation/support-request>)
- Phone: +49 (0)911 895 7222

Further information about our technical support is available in the Internet at Technical support (<http://support.automation.siemens.com/WW/view/en/16604318>)

### Service & Support on the Internet

In addition to our documentation, we offer a comprehensive knowledge base online on the Internet at:

Service and support (<http://www.siemens.com/automation/service&support>)

There you will find:

- The latest product information, FAQs, downloads, tips and tricks.
- Our newsletter, providing you with the latest information about your products.
- A Knowledge Manager to find the right documents for you.
- Our bulletin board, where users and specialists share their knowledge worldwide.
- You can find your local contact partner for Industry Automation and Drives Technologies in our partner database.
- Information about field service, repairs, spare parts and lots more under "Services."

### Additional Support

Please contact your local Siemens representative and offices if you have additional questions about the device

Find your contact partner at:

Local contact person (<http://www.automation.siemens.com/partner>)



## 7.6 Return procedures

Enclose the delivery note, the cover note for return delivery together with the declaration of decontamination form on the outside of the package in a well-fastened clear document pouch.

### Required forms

- **Delivery Note**
- **Cover Note for Return Delivery** with the following information
  - Decontamination declaration  
([http://pia.khe.siemens.com/efiles/feldg/files/Service/declaration\\_of\\_decontamination\\_en.pdf](http://pia.khe.siemens.com/efiles/feldg/files/Service/declaration_of_decontamination_en.pdf))
    - product (ordering number)
    - number of devices or spare parts returned
    - reason for the return
  - **Declaration of Decontamination**
    - Return delivery form (<http://support.automation.siemens.com/WW/view/en/16604370>)
    - With this declaration you certify *that the returned products/spare parts have been carefully cleaned and are free from any residues.*
    - If the device has been operated together with toxic, caustic, flammable or water-damaging products, clean the device before return by rinsing or neutralizing. Ensure that all cavities are free from dangerous substances. Then, double-check the device to ensure the cleaning is completed.
    - We shall not service a device or spare part unless the declaration of decontamination confirms proper decontamination of the device or spare part. Shipments without a declaration of decontamination shall be cleaned professionally at your expense before further proceeding.

You can find the forms on the Internet and on the CD delivered with the device.



## Technical data

### 8.1 Technical specifications

Table 8- 1 Technical data, MASS 2100, Di 3,6,15,25 and 40.

Versions	mm (inch)	DI 3 (1/8)	DI 6 (¼)	DI 15 (5/8)	DI 25 (1)	DI 40 (1½)
Inside pipe diameter (sensor consists of one pipe)	mm (inch)	3.0 (0.12)	6.0 (0.24)	14.0 (0.55)	29.7 (1.17)	43,1(1.70)
Pipe wall thickness	mm (inch)	0.5 (0.02)	1.0 (0.04)	1.0 (0.04)	2,0 (0.08)	2,6 (0.10)
Massflow measuring range	kg/h (lb/inch <sup>3</sup> )	0 ... 250 (0 ... 500)	0 ... 1000 (0 ... 2200)	0 ... 5600 (0 ... 12345)	0 ... 25000 (0 ... 55100)	0 ... 52000 (0 ... 114600)
Density	g/cm <sup>3</sup>	0 ... 2.9 (0 ... 0.10)				
Fraction, e.g.	°Brix	0 ... 100				
Temperature	°C (°F)	-50 ... +180 (-58 ... +356)				
Pressure of liquid in measuring pipe <sup>1)</sup>						
Stainless steel	bar (psi)	230 (3336)	265 (3844)	130 (1885)	110 (1595)	105 (1523)
Hastelloy C-22	bar (psi)	350 (5076)	410 (5946)	200 (2900)	185 (2683)	-
Materials (Measuring pipe, flange and thread connection)	<ul style="list-style-type: none"> <li>• 1.4435/1.4404 (AISI 316L) (stainless steel)</li> <li>• 2.4602 (Hastelloy C-22) (only Di 3, 6 ,15 and 25)</li> </ul>					
Enclosure and enclosure material	<ul style="list-style-type: none"> <li>• IP 65 (NEMA 4)</li> <li>• W 1.4404 AISI 316L) (stainless steel)</li> </ul> <p>Note: Sensor enclosure not rated for pressure containment</p>					
Cable connection	Multiple connector to sensors 5 x 2 x 0.35 mm <sup>2</sup> twisted and shielded pairs, external diameter 12 mm					
EX-version <sup>2)</sup>	EEx ia IIC T3-T6					
Weight, approx. (Sensor only)	kg (lb)	4 (8.8)	8 (17.6)	12 (26.5)	48 (105.8)	70 (154.5)

1) Max. at 20°C, DIN 2413, DIN 17457

2) Intrinsic safety certification CENELEC and ASEV

Table 8- 2 Process connections

Versions	mm (inch)	DI 3 (1/8)	DI 6 (¼)	DI 15 (5/8)	DI 25 (1)	DI 40 (1½)
Flange						
EN 1092-1 PN40		DN 10	DN 10	DN 15	DN 25	DN 40
ANSI B16,5, Class 150		1/2"	1/2"	1/2"	1"	1 1/2"
ANSI B16,5 Class 600 (Class 300)		1/2"	1/2"	1/2"	1"	1 1/2"
Dairy screwed connection (PN 16/25/40) <sup>1)</sup>						
DIN 11851		DN 10	DN 10	DN 15	DN 25	DN 40

8.2 Measurement range

Versions	mm (inch)	DI 3 (1/8)	DI 6 (¼)	DI 15 (5/8)	DI 25 (1)	DI 40 (1½)
ISO 2853/BS 4825 Part 4 (SS3351)		25 mm	25 mm	25 mm	38 mm	51 mm
Dairy clamp connection (PN 16) <sup>1)</sup>						
ISO 2852/BS 4825 Part 3 (SMS3016)		25 mm	25 mm	25 mm	38 mm	51 mm
Thread						
ISO 228/1, PN 100		G1/4" female	G1/4" male	G1/2" male	G1" male	G2" male
ANSI/ASME B1.20.1, PN 100		1/4" NPT female	1/4" NPT male	1/2" NPT male	1" NPT male	2" NPT male

1) Material, 1.4401 or corresponding

## 8.2 Measurement range

### Measuring accuracy of frequency and pulse outputs

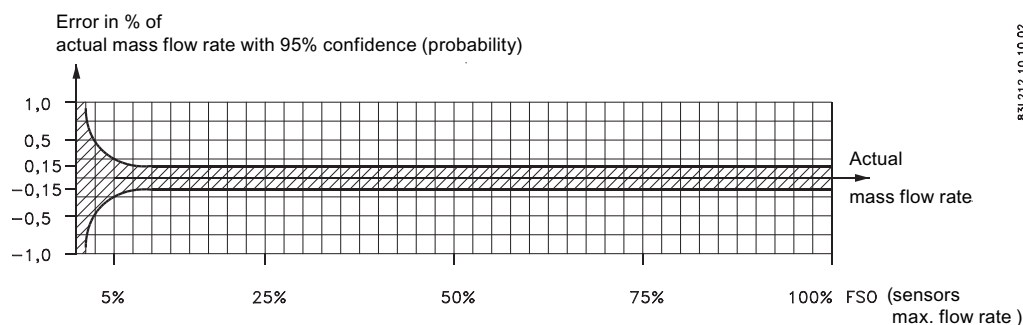

Figure 8-1 Measuring accuracy

Table 8-3 Measurement range

Sensor size		Max. flow of sensor at		
		5 %	50 %	100 %
DI 3	kg/h	12.5	125	250
DI 6	kg/h	50	500	1000
DI 15	kg/h	280	2800	5600
DI 25	kg/h	1250	12500	25000
DI 40	kg/h	2600	26000	52000

- At a flow > 5 % of the max. measurement range, you can directly read the error on the curve.
- At a flow < 5 % of the max. measurement range, use the equation to calculate the error.

The error curve is calculated using the formula:

$$E = \pm \sqrt{(0,10)^2 + \left(\frac{Z \times 100}{Q_m}\right)^2}$$

E error [%]  
Z zero point error [kg/h]  
Q<sub>m</sub> mass flow [kg/h]

Figure 8-2 Equation for error curve

### Example Di3

- Max zero point error Z = 0.01 kg/h
- Measured mass flow Q<sub>m</sub> = 12 kg/h
- Error E = ±0.13%

## 8.3 Accuracy specifications

Table 8- 4 Measuring type errors

Sensor size		DI 3	DI 6	DI 15	DI 25	DI 40
<b>Number of measuring tubes</b>				1		
<b>Massflow</b>						
Linearity error	%			0.10		
Repeatability error	%			0.05		
Max. zero point error	kg/h	0.01	0.05	0.2	1.5	6.0
<b>Density</b>						
Density error	g/cm <sup>3</sup>	0.0015	0.0015	0.0005	0.0005	0.0005
Repeatability error	g/cm <sup>3</sup>	0.0002	0.0002	0.0001	0.0001	0.0001
<b>Temperature error</b>	°C			0.5		
<b>Brix error</b>	°Brix	0.3	0.3	0.1	0.1	0.1

### Reference conditions (ISO 9104 and DIN / EN 29104)

Table 8- 5 Reference conditions

Flow conditions	Fully developed flow profile
Temperature of the medium	20 °C ± 2 K
Ambient temperature	20 °C ± 2 K
Liquid pressure	2 ± 1 bar
Density	0.997 g / cm <sup>3</sup>
Brix	40 ° Brix
Supply voltage	Un ± 1 %
Warming-up time	30 min
Cable length	5 m between transmitter and sensor

**Additional error on deviation from reference conditions**

Current output	As pulse output ( $\pm 0.1\%$ of actual flow +0.05% FSO)
Effect of ambient temperature	Display/Frequency/pulse output: <ul style="list-style-type: none"> <li><math>&lt; \pm 0.003\%</math> / K measured value</li> </ul> Current output: <ul style="list-style-type: none"> <li><math>&lt; \pm 0.005\%</math> / K act.</li> </ul>
Effect of supply voltage	$< 0.005\%$ of measuring value on 1% alteration

**8.4 Pressure drop**

The pressure drop through the instrument is a function of the properties of the fluid viscosity and the flow rate.

In the following charts, the pressure drop for the various sensor sizes is available (Reference density is  $1000 \text{ kg/m}^3$ ). The charts are used for correct sensor dimensioning with regard to capacity, pressure loss and accuracy.

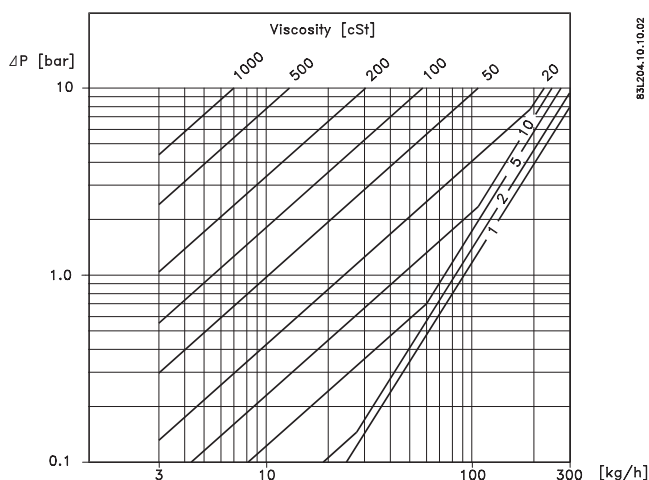

Figure 8-3 MASS 2100 DI3

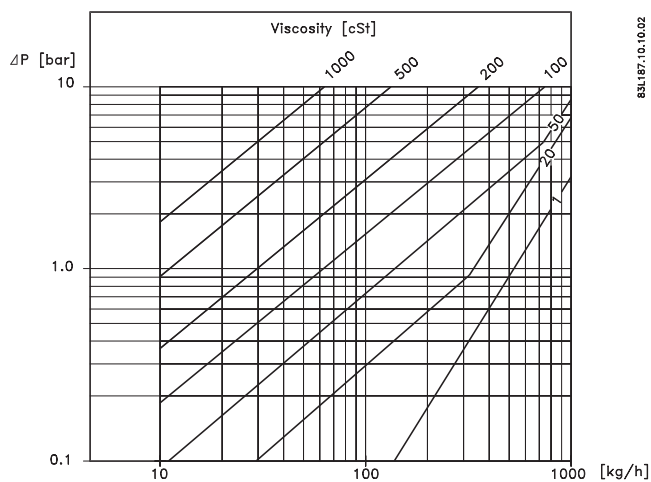

Figure 8-4 MASS 2100 DI6

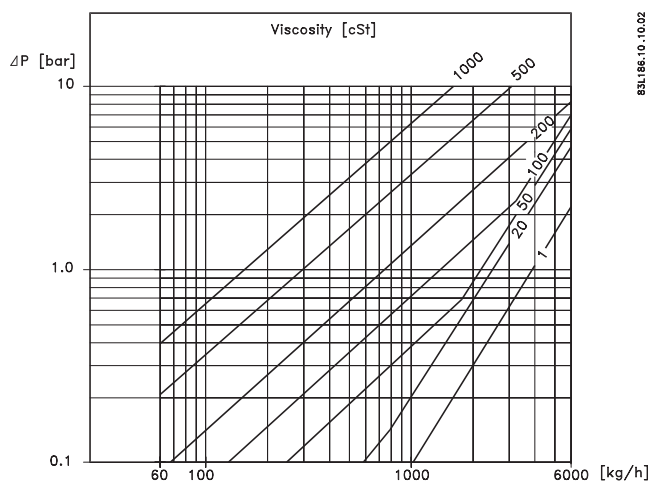

Figure 8-5 MASS 2100 DI15

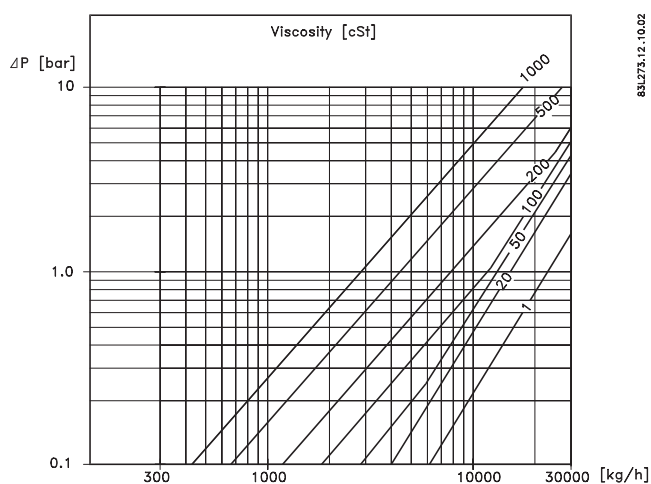

Figure 8-6 MASS 2100 DI25

8.5 Pressure / temperature range

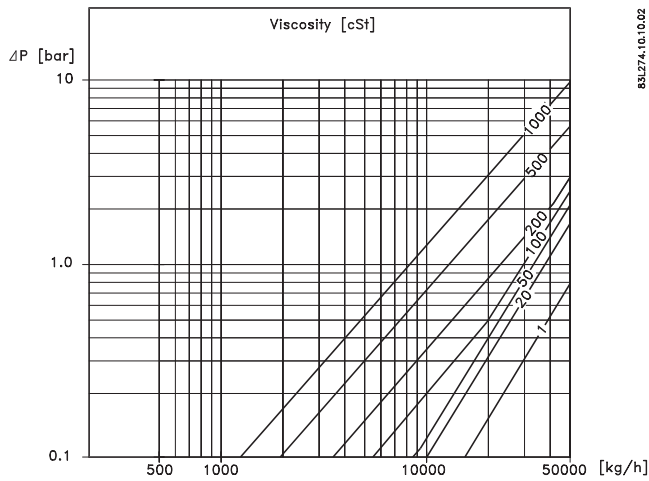

Figure 8-7 MASS 2100 DI40

88.274.10.02

8.5 Pressure / temperature range

The pressure - temperature ratings depend on type of process connection.

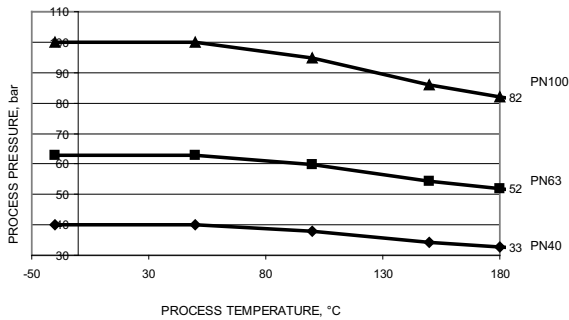

Figure 8-8 Flange EN1092.1 W1.4404 /4435

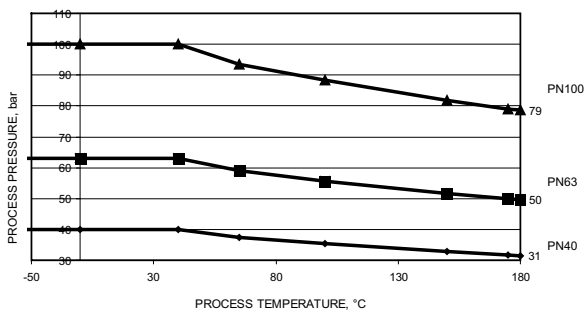

Figure 8-9 Flange EN1092.1, W2.4602



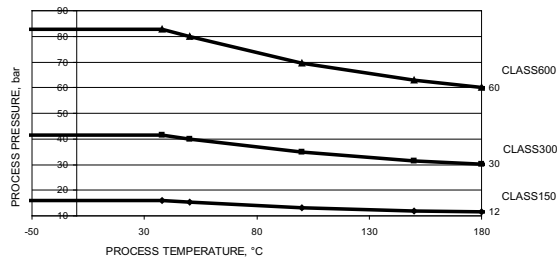

Figure 8-10 Flange ASME B16.5, W1.4404 / 4435

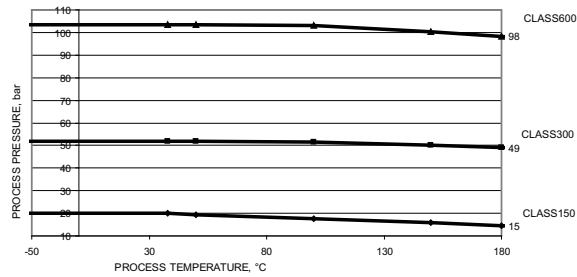

Figure 8-11 Flange ASME B16.5, W2.4602

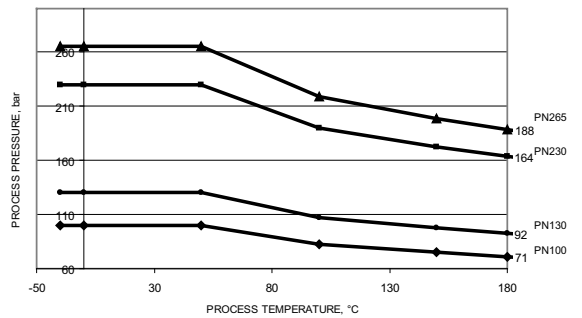

Figure 8-12 Flange ISO228, Pipe thread, W1.4404 / 4435

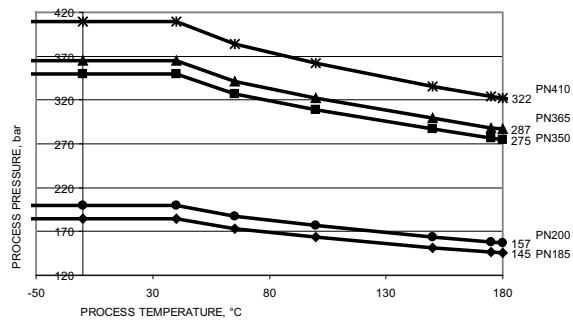

Figure 8-13 Flange ISO228, Pipe thread, W2.4602

8.5 Pressure / temperature range

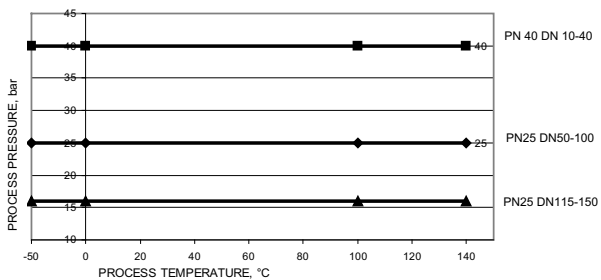

Figure 8-14 Flange DIN 11851, W1.4404

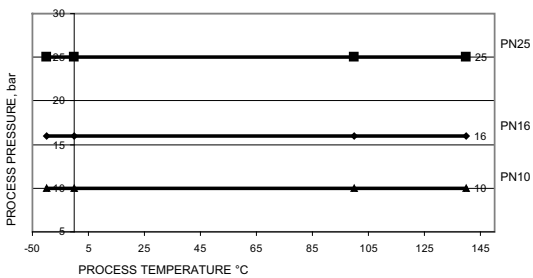

Figure 8-15 Flange DIN 32676, W1.4404

## 8.6 Electrical connection schematics

### Electrical connection, MASS 2100 with MASS 6000 (remote mounted)

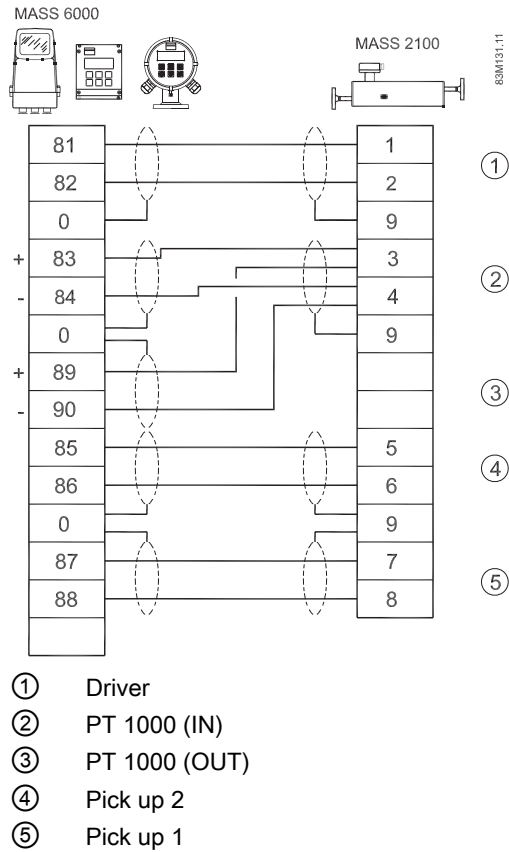
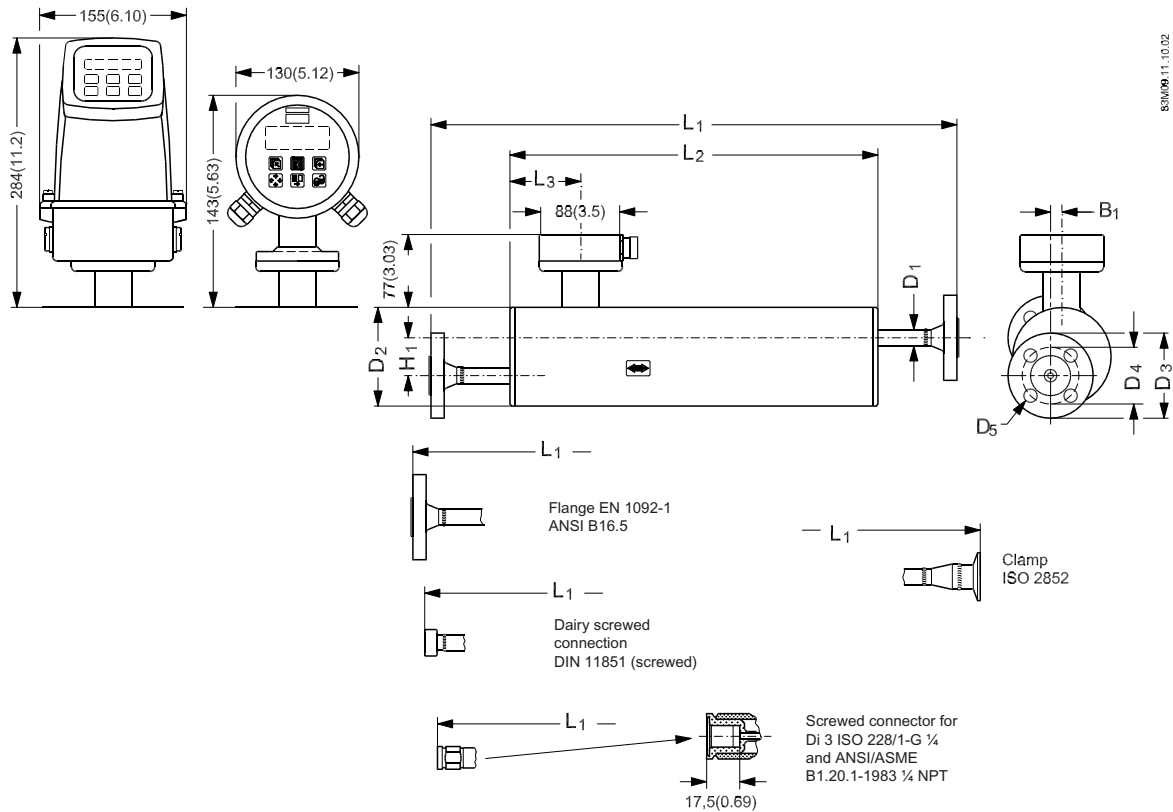

Figure 8-16 MASS 2100 / MASS 6000 Connection

## 8.7 Dimensions and weight

### Remote versions



83MOR11:10.02

Table 8- 6 Dimensions and weight, remote versions

Sensor size	Connection		L1	L2	L3	H1	B1	D1	D2	D3	D4	D5
Di (Inch)	Type (size)	Pressure rating	mm (inch)									
3 (1/8")	Pipe thread ISO 228/1 - G 1/4 (1/4")	PN 100	400 (15.75)	280 (11.02)	75.5 (2.97)	60 (2.36)	0 (0)	21.3 (0.84)	104 (4.09)	-	-	-
	Pipe thread ANSI/ASME B 1.20.1 - 1/4" NPT (1/4")	PN 100	400 (15.75)	280 (11.02)	75.5 (2.97)	60 (2.36)	0 (0)	21.3 (0.84)	104 (4.09)	-	-	-

Sensor size	Connection		L1	L2	L3	H1	B1	D1	D2	D3	D4	D5
DI (Inch)	Type (size)	Pressure rating	mm (inch)									
6 (¼")	Flange EN 1092-1 (DN 10)	PN 100	580 (22.83)	390 (15.35)	62.0 (2.44)	40 (1.57)	12 (0.47)	17.0 (0.67)	104 (4.09)	100 (3.94)	70.0 (2.76)	14.0 (0.55)
		PN 40	560 (22.05)	390 (15.35)	62.0 (2.44)	40 (1.57)	12 (0.47)	17.0 (0.67)	104 (4.09)	90.0 (3.54)	60.0 (2.36)	14.0 (0.55)
	Flange ANSI B16.5 (½")	Class 150	624 (24.57)	390 (15.35)	62.0 (2.44)	40 (1.57)	12 (0.47)	17.0 (0.67)	104 (4.09)	88.9 (3.5)	60.5 (2.38)	15.7 (0.62)
		Class 600	608 (23.94)	390 (15.35)	62.0 (2.44)	40 (1.57)	12 (0.47)	17.0 (0.67)	104 (4.09)	95.3 (3.75)	66.5 (2.62)	15.7 (0.62)
	Screwed connection DIN 11851 (DN10)	PN 40	532 (20.94)	390 (15.35)	62.0 (2.44)	40 (1.57)	12 (0.47)	17.0 (0.67)	104 (4.09)		-	-
	Clamp ISO 2852 (25 mm)	PN 16	570 (22.44)	390 (15.35)	62.0 (2.44)	40 (1.57)	12 (0.47)	17.0 (0.67)	104 (4.09)		-	-
15 (½")	Flange EN 1092-1 (DN15)	PN 100	634 (24.96)	444 (17.48)	75.5 (2.97)	44 (1.73)	20 (0.79)	21.3 (0.84)	129 (5.08)	105 (2.95)	75.0 (4.13)	14.0 (0.55)
		PN 40	620 (24.41)	444 (17.48)	75.5 (2.97)	44 (1.73)	20 (0.79)	21.3 (0.84)	129 (5.08)	95.0 (3.74)	65.0 (2.56)	14.0 (0.55)
	Flange ANSI B16.5 (½")	Class 150	639 (25.16)	444 (17.48)	75.5 (2.97)	44 (1.73)	20 (0.79)	21.3 (0.84)	129 (5.08)	88.9 (3.5)	60.5 (2.38)	15.7 (0.62)
		Class 600	660 (25.98)	444 (17.48)	75.5 (2.97)	44 (1.73)	20 (0.79)	21.3 (0.84)	129 (5.08)	95.3 (3.75)	66.5 (2.62)	15.7 (0.62)
	Screwed connection DIN 11851 (DN15)	PN 40	586 (23.07)	444 (17.48)	75.5 (2.97)	44 (1.73)	20 (0.79)	21.3 (0.84)	129 (5.08)		-	-
	Clamp ISO 2852 (25 mm)	PN 16	624 (24.57)	444 (17.48)	75.5 (2.97)	44 (1.73)	20 (0.79)	21.3 (0.84)	129 (5.08)		-	-
25(1")	Flange EN 1092-1 (DN25)	PN 100	970 (38.19)	700 (27.56)	75.5 (2.97)	126 (4.96)	25 (0.98)	33.7 (1.33)	219 (8.62)	140.0 (3.94)	100.0 (5.51)	18.0 (0.71)
		PN 40	934 (36.77)	700 (27.56)	75.5 (2.97)	126 (4.96)	25 (0.98)	33.7 (1.33)	219 (8.62)	115.0 (4.53)	85.0 (3.35)	14.0 (0.55)
	Flange ANSI B16.5 (1")	Class 150	967 (38.07)	700 (27.56)	75.5 (2.97)	126 (4.96)	25 (0.98)	33.7 (1.33)	219 (8.62)	108.0 (4.25)	79.2 (3.12)	15.7 (0.62)
		Class 600	992 (39.06)	700 (27.56)	75.5 (2.97)	126 (4.96)	25 (0.98)	33.7 (1.33)	219 (8.62)	124.0 (4.88)	88.9 (3.50)	19.1 (0.75)
	Screwed connection DIN 11851 (DN32)	PN 40	922 (36.30)	700 (27.56)	75.5 (2.97)	126 (4.96)	25 (0.98)	33.7 (1.33)	219 (8.62)		-	-

Technical data

8.7 Dimensions and weight

Sensor size	Connection		L1	L2	L3	H1	B1	D1	D2	D3	D4	D5
DI (Inch)	Type (size)	Pressure rating	mm (inch)									
	Clamp ISO 2852 (38 mm)	PN 16	940 (37.01)	700 (27.56)	74.5 (2.93)	126 (4.96)	25 (0.98)	33.7 (1.33)	219 (8.62)	-	-	-
40 (1½")	Flange EN 1092-1	PN 100	1100 (43.31)	850 (33.46)	71.5 (2.81)	180 (7.09)	0 (0)	48.3 (1.9)	273 (10.75)	170.0 (4.92)	125.0 (6.69)	22.0 (0.87)
		PN 40	1063 (41.85)	850 (33.46)	71.5 (2.81)	180 (7.09)	0 (0)	48.3 (1.9)	850 (10.75)	150.0 (5.91)	110.0 (4.33)	18.0 (0.71)
	Flange ANSI B16.5 (1½")	Class 150	1100 (43.31)	850 (33.46)	71.5 (2.81)	180 (7.09)	0 (0)	48.3 (1.9)	850 (10.75)	127.0 (5.91)	98.6 (4.33)	15.7 (0.71)
		Class 600	1128 (44.41)	850 (33.46)	71.5 (2.81)	180 (7.09)	0 (0)	48.3 (1.9)	850 (10.75)	155.4 (6.12)	114.3 (4.50)	22.4 (0.88)
	Screwed connection DIN 11851 (DN 50)	PN 25	1090 (42.91)	850 (33.46)	71.5 (2.81)	180 (7.09)	0 (0)	48.3 (1.9)	850 (10.75)	-	-	-
	Clamp ISO 2852 (51 mm)	PN 25	1062 (41.81)	850 (33.46)	71.5 (2.81)	180 (7.09)	0 (0)	48.3 (1.9)	850 (10.75)	-	-	-

Compact versions

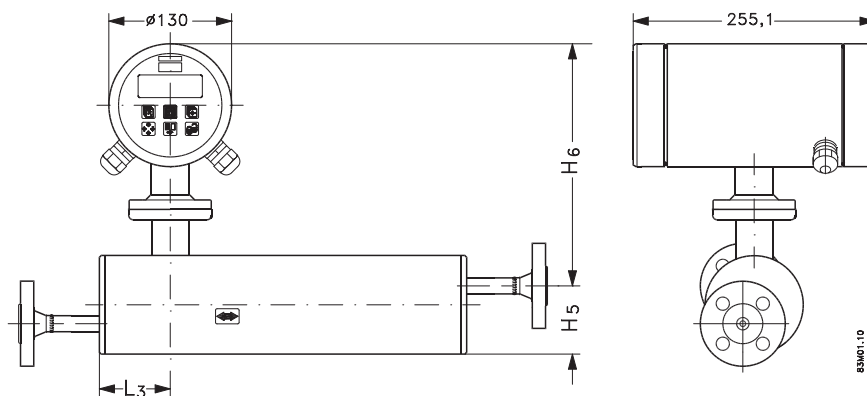

Figure 8-17 MASS 2100 compact mounted with MASS 6000 Ex d

Table 8- 7 MASS 2100 compact mounted with MASS 6000 Ex d

Sensor size [DI (inch)]	L3 mm (inch)	H5 mm (inch)	H6 mm (inch)	H5+H6 mm (inch)
3 (1/8)	75 (2.95)	82 (3.23)	247 (9.72)	329 (12.95)
6 (¼)	62 (2.44)	72 (2.83)	257 (10.12)	329 (12.95)
15 (½)	75 (2.95)	87 (3.43)	267 (10.51)	354 (13.94)
25 (1)	75 (2.95)	173 (6.81)	271 (10.67)	444 (17.48)
40 (1½)	75 (2.95)	227 (8.94)	271 (10.67)	498 (19.61)

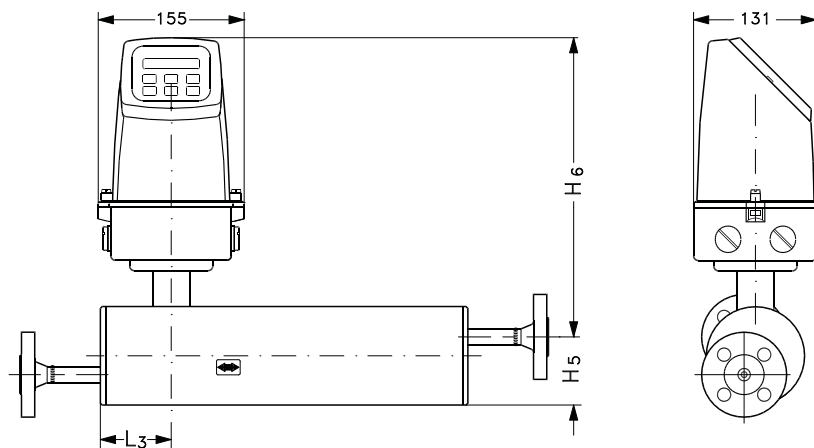

Figure 8-18 MASS 2100 compact mounted with MASS 6000 IP67

Table 8- 8 MASS 2100 compact mounted with MASS 6000 IP67

Sensor size [DI (inch)]	L3 mm (inch)	H5 mm (inch)	H6 mm (inch)	H5+H6 mm (inch)
3 (1/8)	75 (2.95)	82 (3.23)	306 (12.04)	388 (15.28)
6 (¼)	62 (2.44)	72 (2.83)	316 (12.44)	388 (15.28)
15 (½)	75 (2.95)	87 (3.43)	326 (12.83)	413 (16.26)
25 (1)	75 (2.95)	173 (6.81)	330 (13.00)	503 (19.80)
40 (1½)	75 (2.95)	227 (8.94)	330 (13.00)	557 (21.93)

Heating Jacket versions

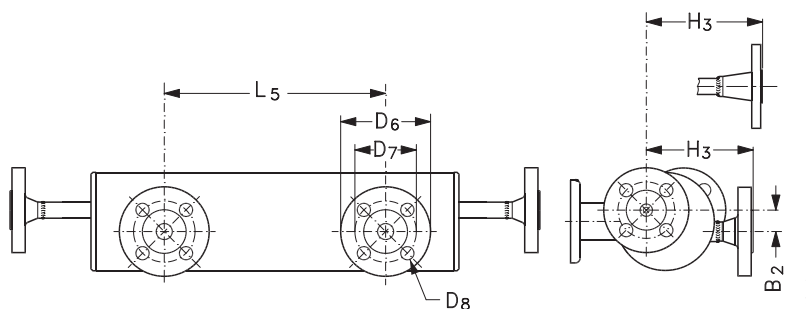

Figure 8-19 Dimensions, MASS 2100 with heating jacket

Table 8- 9 Dimensions, MASS 2100 with heating jacket

Sensor size	Connections		L5	H3	B2	D6	D7	D8
DI (inch)	Type (Size)	Pressure rating	mm (inch)					
DI 3 (1/8")	EN 1092-1 (DN 15)	PN 40	234 (9.21)	122 (4.8)	22 (0.87)	95 (3.74)	65.0 (2.56)	14.0 (0.55)
	ANSI B16.5 (1/2")	Class 150	234 (9.21)	131.6 (5.18)	22 (0.87)	88.9 (3.5)	60.5 (2.38)	15.7 (0.62)
DI 6 (1/4")	EN 1092-1 (DN 15)	PN 40	234 (9.21)	112 (4.41)	22.7 (0.89)	95 (3.74)	65.0 (2.56)	14.0 (0.55)
	ANSI B16.5 (1/2")	Class 150	234 (9.21)	121.6 (4.79)	22.7 (0.89)	88.9 (3.5)	60.5 (2.38)	15.7 (0.62)
DI 15 (1/2")	EN 1092-1 (DN 15)	PN 40	234 (9.21)	126.5 (4.98)	31.5 (1.24)	95 (3.74)	65.0 (2.56)	14.0 (0.55)
	ANSI B16.5 (1/2")	Class 150	234 (9.21)	136.1 (5.36)	31.5 (1.24)	88.9 (3.5)	60.5 (2.38)	15.7 (0.62)
DI 25 (1")	EN 1092-1 (DN 15)	PN 40	420 (16.54)	213.6 (8.41)	60 (2.36)	95 (3.74)	65.0 (2.56)	14.0 (0.55)
	ANSI B16.5 (1/2")	Class 150	420 (16.54)	223.2 (8.79)	60 (2.36)	88.9 (3.5)	60.5 (2.38)	15.7 (0.62)
DI 40 (1 1/2")	EN 1092-1 (DN 15)	PN 40	500 (19.68)	267.5 (10.53)	43 (1.69)	95 (3.74)	65.0 (2.56)	14.0 (0.55)
	ANSI B16.5 (1/2")	Class 150	500 (19.68)	277.1 (10.91)	43 (1.69)	88.9 (3.5)	60.5 (2.38)	15.7 (0.62)



# Appendix

# A

Certificates are posted on the Internet and on the manual collection shipped with the device.

## See also

Certificates on the Internet

(<http://support.automation.siemens.com/WW/view/en/10806951/134200>)

UL control drawings on the internet (<http://www.automation.siemens.com/w1/automation-technology-process-instrumentation-18092.htm#lb-61,related-installationdrawings>)

## A.1 Ordering

In order to ensure that the ordering data you are using is not outdated, the latest ordering data is always available on the Internet: Process instrumentation catalog

(<http://www.siemens.com/processinstrumentation/catalogs>)



# Glossary

## ASIC

Application-Specific Integrated Circuit is an integrated circuit (IC) customized for a particular use, rather than intended for general-purpose use.

## BRIX

Degrees Brix (symbol °Bx) is a measurement of the mass ratio of dissolved sugar to water in a liquid. A 25 °Bx solution is 25% (w/w), with 25 grams of sugar per 100 grams of solution.

## CAN

Controller Area Network. CAN is the leading serial bus system for embedded control. CAN is a mainstream network and was internationally standardized (ISO 11898–1) in 1993.

## Coriolis

The Coriolis effect is an apparent deflection of moving objects from a straight path when they are viewed from a rotating frame of reference. The effect is named after Gaspard-Gustave Coriolis, a French scientist who described it in 1835. The Coriolis effect is caused by the Coriolis force, which appears in the equation of motion of an object in a rotating frame of reference.

## DFT

The discrete Fourier transform (DFT) is one of the specific forms of Fourier analysis. As such, it transforms one function into another, which is called the frequency domain representation, or simply the DFT, of the original function (which is often a function in the time domain). The DFT evaluates enough frequency components to reconstruct the finite segment that was analyzed. The DFT is thus a transform for Fourier analysis of finite-domain discrete-time functions.

## EMC

Electromagnetic compatibility (EMC) is the branch of electrical sciences which studies the unintentional generation, propagation and reception of electromagnetic energy with reference to the unwanted effects (Electromagnetic Interference, or EMI) that such energy may induce. The goal of EMC is the correct operation, in the same electromagnetic environment, of different equipment which use electromagnetic phenomena, and the avoidance of any interference effects.

## Fraction

Fraction designates a proportional relation between an object part and the object whole. For example, the fraction  $\frac{3}{4}$  represents three equal parts of a whole object, divided into four equal parts.

## HART

HART Communication is a bi-directional industrial field communication protocol used to communicate between intelligent field instruments and host systems. HART is the global standard for smart process instrumentation and the majority of smart field devices installed in plants worldwide are HART-enabled. HART technology is easy to use and very reliable

## IP

An IP (Ingress Protection) number is used to specify the environmental protection of enclosures around electronic equipment. These ratings are determined by specific tests. The IP number is composed of two numbers, the first referring to the protection against solid objects and the second against liquids. The higher the number, the better the protection. For example, in IP67 the first Number (6) means that the device is totally protected against dust, and the second (7) that it is protected against the effect of immersion between 15cm and 1m

## MODBUS

MODBUS is a serial communications protocol intended for use with programmable logic controllers (PLCs). MODBUS allows for communication between many devices connected to the same network, for example a system that measures temperature and humidity and communicates the results to a computer. MODBUS is often used to connect a supervisory computer with a remote terminal unit (RTU) in supervisory control and data acquisition systems.

## NAMUR

Normenarbeitsgemeinschaft für Meß- und Regeltechnik in der Chemischen Industrie (NAMUR). NAMUR is a group representing the interests of the chemical industry which create standards for instrumentation and electrical devices used in industrial plants.

## PED

The Pressure Equipment Directive (97/23/EC) is the legislative framework on European level for equipment subject to a pressure hazard. It was adopted by the European Parliament and the European Council in May 1997 and has been obligatory throughout the European Union since May 2002.

## Plato

Plato is a measure of the weight of the solids dissolved in water. It is expressed in %.

## PROFIBUS

PROFIBUS (Process Field Bus) is a vendor-independent, open bus system standardized in the German DIN 19 245. It is a standard for field bus communication in automation technology and should not be confused with the PROFINET standard for industrial Ethernet. PROFIBUS-PA (Process Automation) is one of three PROFIBUS variants that are compatible with each other. PROFIBUS-DP (Decentralized Periphery)

## SENSORPROM

All sensor related settings/data saved on an EPROM. SENSORPROM technology automatically configures the transmitter at start up providing calibration data, pipe size, sensor type, and output settings. The SENSORPROM automatically stores values or settings changed by users, and automatically re-programs any new transmitter without loss of accuracy.

## Turndown ratio

'Turndown ratio' is a flow measurement term indicating the range a specific flow meter, or meter type, is able to measure with specific accuracy. It is also known as rangeability. If a gas flow to be measured is expected to vary between 100,000 m<sup>3</sup> per day and 1,000,000 m<sup>3</sup> per day, the specific application has a turndown ratio of at 10:1. Therefore the meter requires a turndown ratio of at least 10:1.

## USM

USM II is a Communication Platform. The Siemens USM II concept enables fitting of add-on bus modules without loss of functionality:

1. All modules can be fitted as true "plug & play"
2. Module and transmitter are automatically configured through the SENSORPROM

## Zero point adjustment

In order to measure accurately with a measuring instrument it is important that zero and gain have been calibrated. All Coriolis sensors are calibrated before they are sent out to customers. However, Coriolis sensors are very sensitive, and several factors might move the zero point, e.g installation, pressure, temperature and even very small vibrations coming from the process. All these factors are customer specific and can't be simulated at the factory. Therefore Siemens recommends to carry out a zero point adjustment before use.



# Index

## A

Accuracy, 38  
Accuracy specifications, 39

## C

Commissioning  
    Zero point adjustment, (See Zero point adjustment)  
Compliance, 11  
Connection  
    Electrical, (See Electrical connection)  
Contact person, 9  
Coriolis  
    Applications, 15  
    Measurement principle, 17  
Crosstalk, 24  
Customer Support Hotline, 34

## D

Decontamination, 35  
Design, 16  
Device  
    Identification, 8  
    Inspection, 7  
Dimensions  
    Compact versions, 49  
    Heating Jacket version, 50  
    Remote versions, 46  
Document history, 8

## E

Electrical connection, 45  
    Basic requirements, 27

## F

Flow direction, 21

## H

Hazardous area

    Temperature specifications, 13  
Hazardous area  
    Approvals, 12  
    Safety requirements, 13  
Heating Jacket, 17  
Hotline, 34

## I

Installation  
    Drop line, 22  
    Gas, 20  
    Indoor/outdoor, 19  
    Inlet / Outlet conditions, 20  
    Liquid, 20  
    Location in the system, 20  
    Mounting of sensor, 23  
    Pressure guard, 24  
    Safety instructions, 19  
    Sensor orientation, 21  
    Upstream / Downstream, 20  
Internet  
    Contact person, 9, 34  
    Flowdocumentation, 9  
    Support, 34  
Intrinsically safe data, 12  
Introduction, 7  
Items supplied, 7

## L

Laws and directives, 11

## M

Mains supply, 27  
Maintenance, 33  
Material compatibility, 11  
Measurement range, 38  
Mounting, (See Installation)

## P

Pickup driver circuit, 13  
Pressure  
    Safety instructions, 19

Pressure / temperature ratings, 42  
Pressure drop, 40

## **R**

Recalibration, 33  
Reference conditions, 39  
Repair, 34  
Return procedures, 35

## **S**

Safety  
    Instrument safety standards, 11  
Safety instructions  
    Installation, 19  
Safety notes, 11  
Sensor circuit, 12  
Sensor orientation, (See Installation)  
SENSORPROM, 18  
Service, 34  
Support, 34

## **T**

Technical data, 37  
Temperature sensor circuit, 12  
Temperature specifications, 13  
Theory of operation, 17  
Type plate, 8

## **V**

Versions, 15  
Vibrations, 23

## **Z**

Zero point adjustment, 32  
    basic requirements, 31





## For more information

[www.siemens.com/flow](http://www.siemens.com/flow)

Siemens A/S  
Flow Instruments  
DK-6430 Nordborg  
DENMARK

Subject to change without prior notice  
Order No.: A5E02896535  
Literature No.: A5E02896535-01  
SFIDK.PS.028.Z1.02  
Copyright Siemens A/S 07/2010  
All rights reserved



\* A 5 E 0 2 8 9 6 5 3 5 \*

[www.siemens.com/processautomation](http://www.siemens.com/processautomation)