

Replacement Battery (HRB-U30-S100) Manual

For use with HOBO® RX3000 and U30 Stations



Testing the Battery (Optional)

Each replacement battery is shipped fully charged. However, if you want to check the battery voltage before installing it, you can use a voltmeter to verify that it has an adequate charge. If the voltage is less than 4.0 volts, charge the battery externally with a current-limited variable power supply. Hold the battery across a constant voltage source of 4.5 volts with a current limit of 1 Amp. It takes up to 24 hours to fully charge a dead battery.

IMPORTANT: Do not apply more than 4.6 volts absolute maximum to the battery. Do not exceed 1 Amp of current when charging. If the battery gets hot, immediately stop charging the battery.

Replacing the Battery in a HOBO RX3000 Station

1. If the RX3000 station is currently logging, press the Stop button to stop it.
2. Press the Connect button and wait for the station to connect to HOBOLink so that all the latest data is offloaded before changing the battery.
3. Power down the station (unplug any charging device and then disconnect the battery).

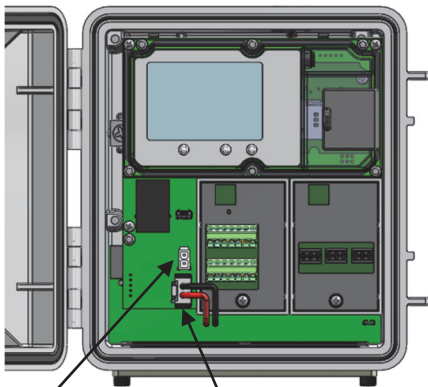

Unplug the solar panel or AC adapter

Disconnect the battery

4. If the optional modules are installed as shown in the previous example, disconnect any analog sensors or relay devices.
5. Unplug any smart sensors.
6. For RX3001 models, unplug the Ethernet cable.
7. Remove the station from its deployment location (e.g. remove it from a tripod or mast or unscrew it from its

mounting surface). Bring the station indoors if it is normally deployed outside. Ground yourself once inside (touch a metal object) to prevent static discharge.

8. Using a Phillips-head screwdriver, unscrew the bottom screw on the module(s) until loosened. The screw will remain attached to the module(s).

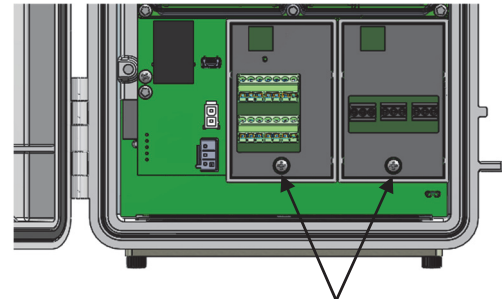

Unscrew until loosened

9. With your fingers on the top and bottom edges of the module, carefully pull the module(s) out of the slot(s).
10. For RX3003 and RX3004 cellular models, unplug the rubber grommet.

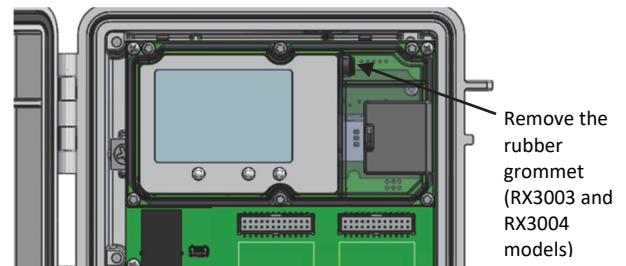

Remove the rubber grommet (RX3003 and RX3004 models)

Note that once the rubber grommet is unplugged, it will remain on the antenna cable as shown below.

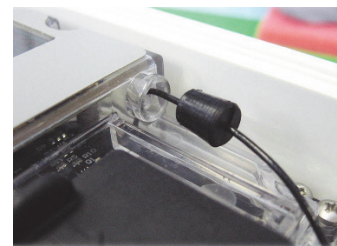

11. Using a Phillips-head screwdriver, unscrew the four screws on the board.

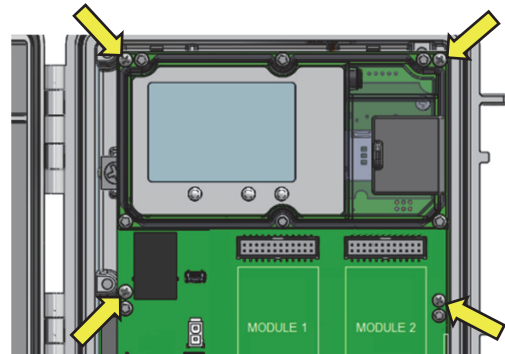

12. Carefully set the board on its side as shown below; do not remove it from the enclosure.

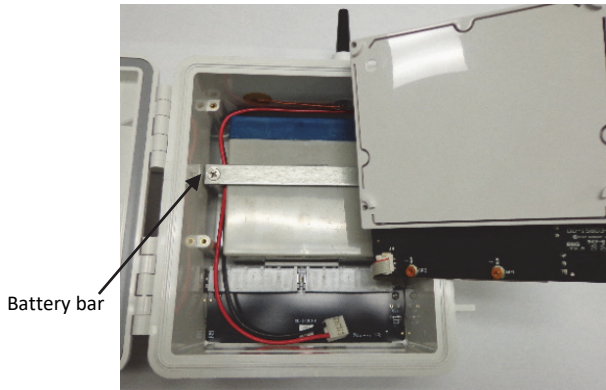

be able to reach the battery connector on the board when you plug it back in a later step.

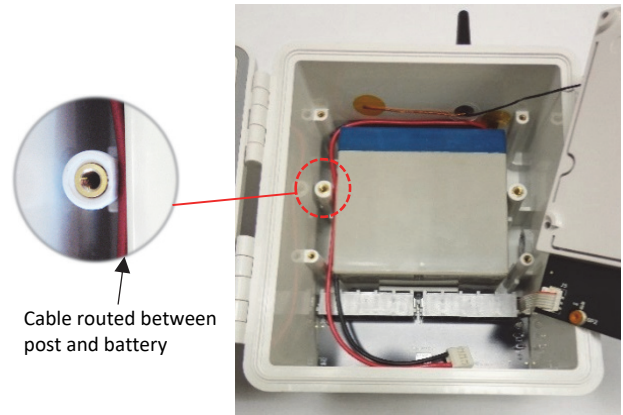

- 13. Using a Philips-head screwdriver, unscrew and remove the bar that secures the battery.
- 14. Remove the battery. Use the battery cables to pull the battery out of the enclosure.
- 15. Remove the protective caps from the terminals of the replacement battery.
- 16. Connect the red wire of the cable to the positive (+) terminal and the black wire to the negative (-) terminal. Terminals are color coded. ALWAYS confirm polarity.

19. Reinstall the battery bar making sure the foam side faces down to cushion the battery. On RX3003 models, make sure the battery cable is below the antenna as shown here.

CAUTION: Make sure the battery cable is routed below the battery bar as shown to avoid possible shorting hazard!

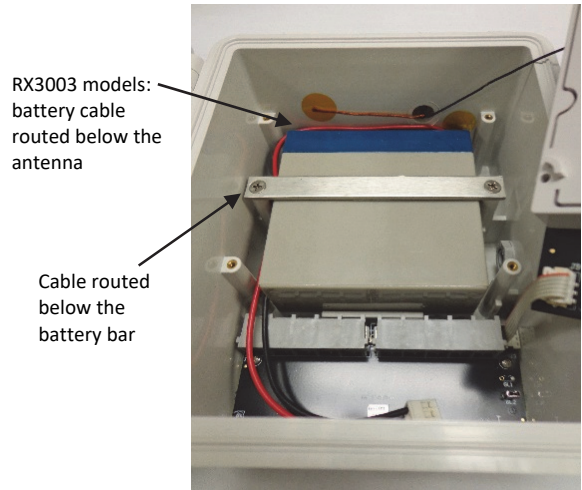
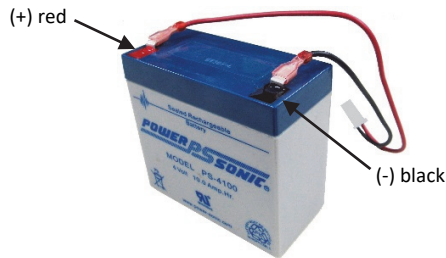

17. Install the battery with the positive (+) terminal towards the upper right corner of the case. Insert the battery at an angle, with the bottom against the shelf in the case, as shown. Press the battery down flat into place and then push it to the right to make room for the cable.

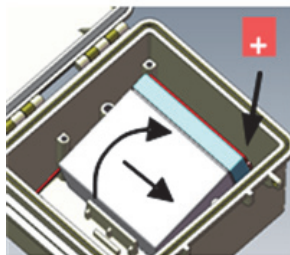

20. Place screws back in the board and then reposition the board back into place. Tighten the screws until finger-tight plus one quarter turn; do not overtighten.

21. For RX3003 and RX3004 models, guide the rubber grommet along the antenna cable and plug it back in

18. Make sure the cable is positioned as shown, routed between the battery and center left post. This ensures the cable will

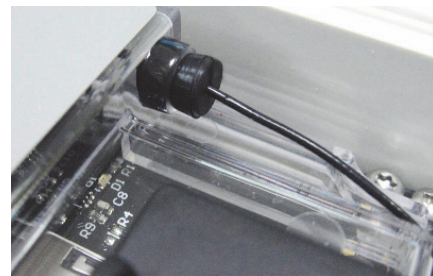

- For RX3004 models, make sure the antenna wire is neatly tucked in as shown below and not at risk of being pinched when the logger door is closed.

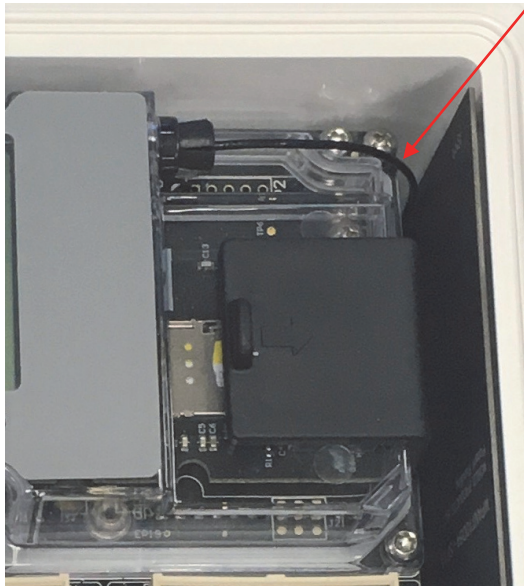

RX3004 models:
antenna cable
tucked in

- Reinstall any modules by inserting the connector on the back of the module(s) into the receptacle(s) in the module slot(s) on the board. Make sure you reinstall the modules in the same slot where they were previously installed.

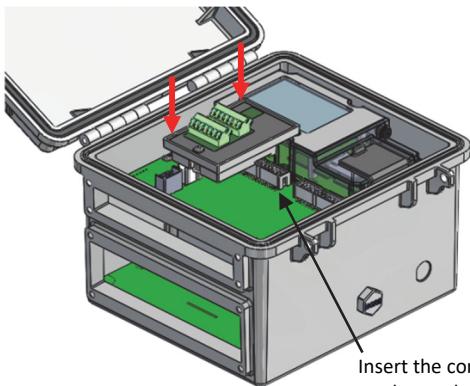

Insert the connectors
on the module here

- Using a Phillips-head screwdriver, tighten the screw at the bottom of the module(s).
- Reconnect any analog sensors or relay devices.
- For RX3001 models, plug the Ethernet cable back in.
- Plug the battery cable back in and then the solar panel or AC adapter. Once the battery cable is plugged in, "Initializing System" will flash on the LCD. A checkmark appears next to "System" after the station initialization is complete. Make sure the station connects to HOBOLink (press the Connect button on the station if needed)
- Plug any smart sensors back in.
- Press the Select button to view the smart sensors on the LCD screen.

- Press the Search button for the station to detect all the smart sensors currently connected.

- Press the Start button to begin logging again.

IMPORTANT: Recharge the battery when not in use. Due to the self-discharge characteristics of this type of battery, it is imperative that you charge the battery for at least 12 hours every six months at a minimum if the battery is not being actively used. Otherwise, permanent loss of battery capacity may occur.

Replacing the Battery in a HOBO U30 Station

- Open the U30 enclosure and disconnect the external power source (AC adapter or solar panel) first, then the battery, and finally any smart sensors. For U30 cellular and U30 Wi-Fi models, use a 5/16" wrench to unscrew the antenna connection. For the U30 Ethernet model, disconnect the Ethernet cable.
- Remove the station from its deployment location (e.g. remove it from a tripod or mast or unscrew it from its mounting surface). Bring the station indoors if it is normally deployed outside. Ground yourself once inside (touch a metal object) to prevent static discharge.
- Use a Phillips-head screwdriver to remove the four screws at the corners of the logger (clear inner case), and then remove the logger.

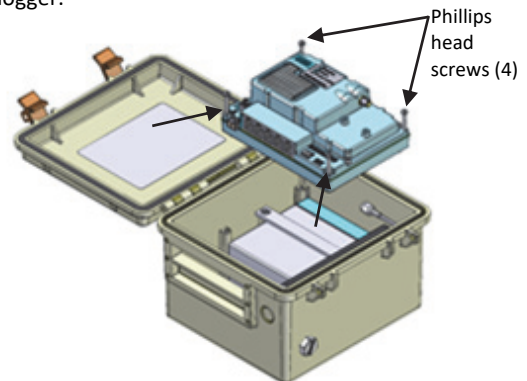

- Use a Phillips-head screwdriver to remove the bar that secures the battery.

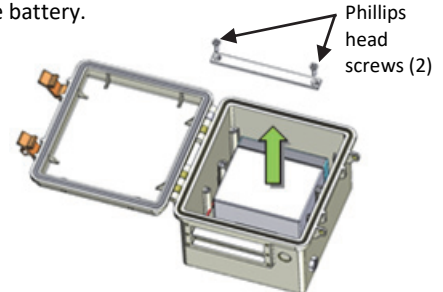

- Remove the battery. Remove the cable from the old battery.
- Remove the protective caps from the terminals of the replacement battery.

- Connect the red wire of the cable to the positive (+) terminal and the black wire to the negative (-) terminal. Terminals are color coded. ALWAYS confirm polarity.

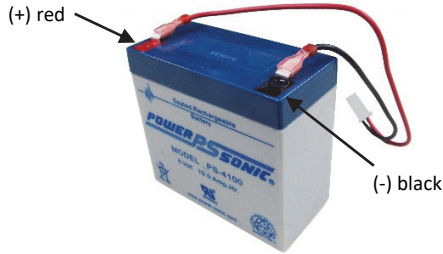

- Install the battery with the positive (+) terminal towards the upper right corner of the case. Insert the battery at an angle, with the bottom against the shelf in the case, as shown. Press the battery down flat into place and then push it to the right to make room for the cable. Make sure the cable is positioned as shown below, routed between the battery and center left post. This ensures the cable will be able to reach the battery connector on the logger when that is added back in later.

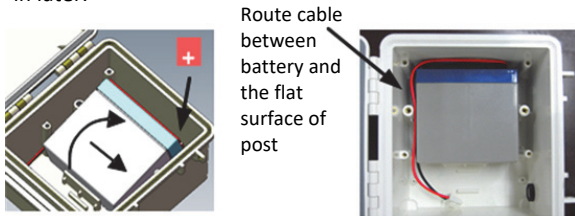

- Reinstall the battery bar. If the bar has foam on one side, make sure the foam side faces down.

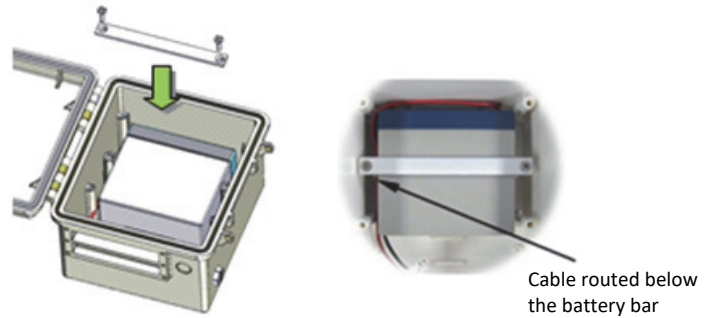

CAUTION: Make sure the battery cable is routed below the battery bar as shown to avoid possible shorting hazard!

- Reinstall the logger into the enclosure. For U30 GSM and U30 Wi-Fi models, reconnect the antenna. For the U30 Ethernet model, reconnect the Ethernet cable. Plug in the smart sensors first, then the battery, and finally the external power source (AC adapter or solar panel).

IMPORTANT: Recharge the battery when not in use. Due to the self-discharge characteristics of this type of battery, it is imperative that you charge the battery for at least 12 hours every six months at a minimum if the battery is not being actively used. Otherwise, permanent loss of battery capacity may occur.

⚠ Important Lead Acid Battery Information

- Use protective eye wear when testing, charging and/or handling the batteries.
- Do not attempt to disassemble batteries.
- Contact with sulfuric acid may cause harm. Should contact occur, wash skin and/or clothes with liberal amounts of water.
- Do not throw batteries into fire; batteries so disposed may rupture or explode.
- Disassembled batteries are hazardous waste and must be treated accordingly.
- It is unlawful to dispose of batteries except through a recycling center.