

# HOBO® MX Analog/Temp/RH/Light (MX1104) and MX 4-Channel Analog (MX1105) Data Logger Manual



MX1105 Model Shown

The HOBO MX Analog/Temp/RH/Light (MX1104) and HOBO MX 4-Channel Analog (MX1105) data loggers measure and transmit data wirelessly from indoor environments to a mobile device or computer using Bluetooth® Low Energy technology. The MX1104 model has integrated temperature, relative humidity (RH), and light intensity sensors and one analog input while the MX1105 model has four analog inputs. Both models support a wide variety of external sensors (sold separately), including self-describing temperature, split-core AC current transformer, 4-20 mA input, and DC voltage input sensors. The self-describing sensors are designed with integrated strain relief for a secure connection to the loggers and are automatically detected by the HOBObconnect® app for easy setup. Using the app, you can configure the loggers, read out and view data, and export the data for further analysis. The loggers can calculate minimum, maximum, average, and standard deviation statistics and can also be configured to trip audible or visual alarms at thresholds you specify. In addition, both loggers support burst logging in which data is logged at a different interval when sensor readings are above or below certain limits. These compact loggers also have built-in LCD screens to display current sensor readings, logging status, battery use, memory consumption, and more.

## HOBO MX1104 and MX1105 Data Loggers

### Models:

- Analog/Temp/RH/Light (MX1104)
- 4-Channel Analog (MX1105)

### Included Items:

- Tie wraps
- Two AAA 1.5 V alkaline batteries (installed)

### Required Items:

- HOBObconnect app
- Mobile device with Bluetooth and iOS, iPadOS®, or Android™, or a Windows computer with a native BLE adapter or supported BLE dongle

## Specifications

### Temperature Sensor (MX1104)

<b>Range</b>	-20° to 70°C (-4° to 158°F)
<b>Accuracy</b>	±0.20°C from 0° to 50°C (±0.36°F from 32° to 122°F)
<b>Resolution</b>	0.002°C at 25°C (0.004°F at 77°F)
<b>Drift</b>	<0.1°C (0.18°F) per year

### RH Sensor\* (MX1104)

<b>Range</b>	0% to 100% at -20° to 70°C (-4° to 158°F); exposure to conditions above 95% may temporarily increase the maximum RH sensor error by an additional 1%
<b>Accuracy</b>	±2.5% from 10% to 90% (typical) to a maximum of ±3.5% including hysteresis at 25°C (77°F); below 10% and above 90% ±5% typical
<b>Resolution</b>	0.01%
<b>Drift</b>	<1% per year typical

### Response Time (MX1104)

<b>Temperature</b>	11 minutes in air moving 1 m/s (2.2 mph)
<b>RH</b>	30 seconds to 90% in airflow of 1 m/s (2.2 mph)

### Light Sensor (MX1104)

<b>Range</b>	0 to 167,731 lux (15,582 lum/ft <sup>2</sup> )
<b>Accuracy</b>	±10% typical for direct sunlight (see <i>Light Measurement</i> on page 4 for more details)

Logger with Cable Type	SD-MA-420 or CABLE-4-20mA	SD-VOLT-2.5 or CABLE-2.5-STEREO	SD-VOLT-05 or CABLE-ADAP5	SD-VOLT-10 or CABLE-ADAP10	SD-VOLT-24 or CABLE-ADAP24
<b>Measurement Range</b>	0 to 20.1 mA	0 to 2.5 V	0 to 5.0 V	0 to 10 V	0 to 24 V
<b>Accuracy</b>	±0.001 mA ±0.2% of reading	±0.1 mV ±0.1% of reading	±0.2 mV ±0.3% of reading	±0.4 mV ±0.3% of reading	±1.0 mV ±0.3% of reading
<b>Resolution</b>	0.3 µA	40 µV	80 µV	160 µV	384 µV

### Logger

<b>Operating Range</b>	-20° to 70°C (-4° to 158°F)
<b>Radio Power</b>	1 mW (0 dBm)

## Specifications (continued)

<b>Transmission Range</b>	Approximately 30.5 m (100 ft) line-of-sight
<b>Wireless Data Standard</b>	Bluetooth Low Energy (Bluetooth Smart)
<b>Logging Rate</b>	1 second to 18 hours
<b>Logging Modes</b>	Fixed interval (normal, statistics) or burst
<b>Memory Modes</b>	Wrap when full or stop when full
<b>Start Modes</b>	Immediate, push button, date & time, or next interval
<b>Stop Modes</b>	When memory full, push button, date & time, or after a set logging period
<b>Restart Mode</b>	Push button
<b>Time Accuracy</b>	±1 minute per month at 25°C (77°F)
<b>Battery Type</b>	Two AAA 1.5 V alkaline batteries, user replaceable
<b>Battery Life</b>	1 year, typical with logging interval of 1 minute and Bluetooth Always On enabled; 2 years, typical with logging interval of 1 minute and Bluetooth Always On disabled; and temperatures between 0° and 50°C (32° and 122°F). Faster logging intervals and statistics sampling intervals, burst logging, remaining connected with the app, excessive downloads, and paging may impact battery life.
<b>Memory</b>	4 MB (1.9 million measurements, maximum)
<b>Full Memory Download Time</b>	Approximately 4 to 15 minutes depending on the mobile device; may take longer the further the device is from the logger
<b>LCD</b>	LCD is visible from 0° to 50°C (32° to 122°F); the LCD may react slowly or go blank in temperatures outside this range
<b>Size</b>	11.28 x 5.41 x 2.92 cm (4.44 x 2.13 x 1.15 in.)
<b>Weight</b>	123 g (4.34 oz)
<b>Environmental Rating</b>	IP54
	The CE Marking identifies this product as complying with all relevant directives in the European Union (EU).
	See last page

\*Per RH sensor manufacturer data sheet

## Logger Components and Operation

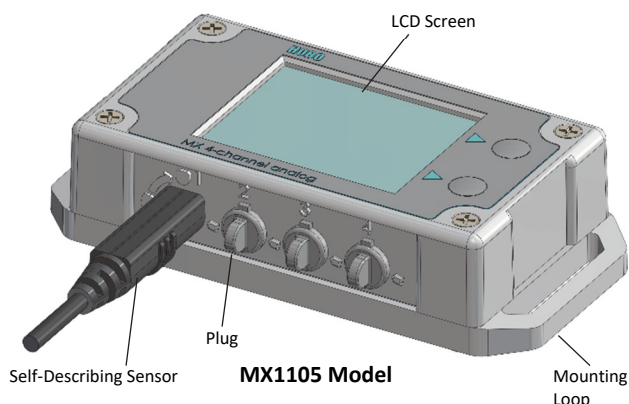
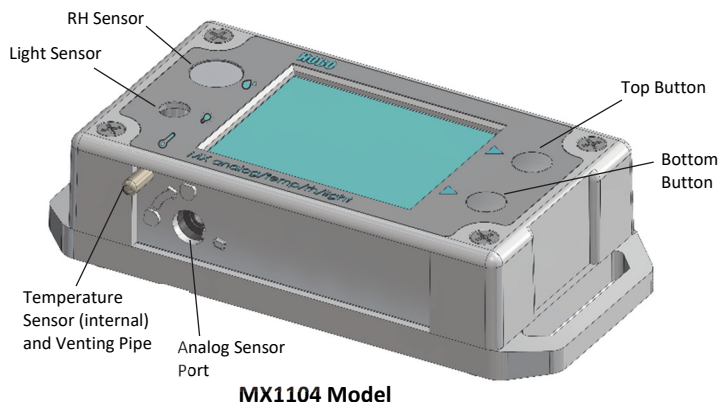

**RH Sensor:** This sensor is located in the upper left corner and to the left of the LCD screen in the MX1104 model.

**Light Sensor:** This sensor is located below the RH sensor and to the left of the LCD screen in the MX1104 model.

**Temperature Sensor:** This sensor is located in the bottom left corner and to the left of the LCD screen in the MX1104 model. A small pipe protrudes from the bottom side of the logger case to vent the temperature sensor.

**Analog Sensor Port:** Use this 2.5 mm jack to connect a self-describing sensor or other analog sensor. The MX1104 model has one port and the MX1105 model has four ports.

**Top Button:** Press this button for 3 seconds to start or stop logging data, or to resume logging on the next even logging interval. This requires configuring the logger in the app with a push button start or stop, and with Allow Button Restart selected (see *Configuring the Logger*).

You can also press the top button for 1 second to wake up the logger, bring the logger to the top of the list in the app, cycle through each channel on the LCD, silence a beeping alarm (see *Setting up Alarms*), and turn the LCD screen on if the option to turn off the LCD has been enabled (see *Configuring the Logger*).

**Bottom Button:** When statistics are being logged, press this button for 1 second to switch between the latest sensor reading, statistics, and an alarm reading (if applicable) for the channel currently displayed. If no statistics are being logged and a sensor alarm trips, press this button for 1 second to view the alarm reading for the channel currently displayed. You can also press this button for 1 second to wake up the logger, silence a beeping alarm, or turn the LCD screen on if the option to turn off the LCD has been enabled. Press this button for 3 seconds to clear a visual alarm if the logger was configured in the app to maintain the visual alarm until the alarm button was pressed (see *Setting up Alarms*). Press both the top and bottom buttons simultaneously for 10 seconds to reset a logger password.

**Self-Describing Sensor:** This is a type of external sensor available for MX1104 and MX1105 loggers. Turn the sensor plug one-quarter clockwise when inserting it into an analog sensor port to secure it in place. This sensor also features automatic detection by the logger (see *Working with Sensors*).

**Plug:** Use this Santoprene® (TPE) plug to fill an empty analog sensor port.

**Mounting Loops:** Use the two mounting loops (only one visible in the diagrams) to mount the logger with tie wraps (see *Mounting the Logger*).

**LCD Screen:** This logger is equipped with an LCD screen that displays details about the current status. This example shows all symbols illuminated on the LCD screen followed by definitions of each symbol.

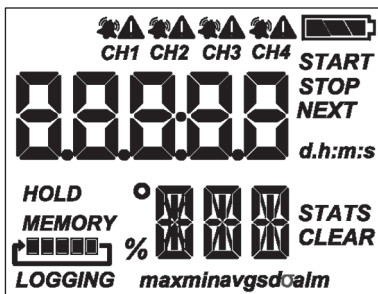

LCD Symbol	Description
<b>START</b>	The logger is waiting to be started or restarted. Press and hold the top button for 3 seconds to start the logger; HOLD will also be displayed during this time.
<b>STOP</b>	The logger has been started with push button stop enabled. Press and hold the top button for 3 seconds to stop the logger; HOLD will also be displayed during this time.
<b>HOLD</b>	This is displayed while pressing the top button for 3 seconds to start, stop, or restart the logger, or while pressing the bottom button for 3 seconds to clear an alarm.
<b>NEXT</b>	This is displayed when there is more than one channel being logged. Press the top button to cycle through each channel to view sensor measurements.

LCD Symbol	Description
<b>STATS</b>	Statistics are being logged. Press the bottom button to switch between the current sensor readings, statistics, and any alarm readings for each channel.
<b>max min avg std</b>	These symbols show the maximum, minimum, average, and standard deviation values most recently calculated by the logger (if the logging mode has been set to Fixed Interval in the app and each statistic has been selected; see <i>Statistics Logging</i> ). Press the bottom button to cycle through the available statistics and then back to the current sensor reading (or to the alarm value if applicable).
	The battery indicator shows the approximate battery power remaining.
<b>MEMORY</b> 	The logger has been configured to stop logging when memory fills. The memory bar indicates the approximate space remaining in the logger to record data. When first started, all five segments in the bar will be empty. In this example, the logger memory is almost full (only one segment in the memory bar is empty).
<b>MEMORY</b> 	The logger has been configured to never stop logging (wrapping). The logger will continue recording data indefinitely, with newest data overwriting the oldest data until the battery voltage is depleted or the logger is reconfigured. When first launched, all five segments in the memory bar will be empty. In this example, the memory is full (all five segments are filled in) and new data is now overwriting the oldest data.
<b>LOGGING</b>	The logger is currently logging.
	This indicates a sensor alarm has tripped. Press the top button to view the channel with the alarm icon. Press the bottom button to view the reading that tripped the alarm. The "alm" symbol (described below) is displayed on the screen with the reading (or dashes if the alarm has already cleared). This symbol at left will clear depending on how visual alarms were configured in the app. If the visual alarm was set to clear when the logger is reconfigured, this symbol will remain on the LCD until the next time new configure settings are loaded onto the logger (see <i>Configuring the Logger</i> ). Otherwise, it will clear when the sensor reading is back within the alarm limits or by pressing the bottom button for 3 seconds.
<b>alm</b>	This is displayed with the reading that tripped the alarm. While viewing the channel with the alarm, press the bottom button to see the reading (you may need to cycle through statistics readings first if applicable). If the alarm cleared, dashes (- - -) will display instead of a reading.
<b>CLEAR</b>	A visual alarm is ready to be cleared. This will only appear if the app was configured to maintain the visual alarm until the alarm button is pressed. While viewing the channel with the alarm on the LCD, press the bottom button for 3 seconds to clear the visual alarm. Note that an audible alarm can be silenced by pressing the top or bottom button for 1 second.
	This indicates a problem with an external sensor. See <i>Working with External Sensors</i> for more details.

LCD Symbol	Description
	This is an example of a sensor reading, with the latest reading displayed above the unit type for that sensor. To switch between US and SI units, change the units in the app Settings (the logger must be reconfigured for units changes to take effect). <b>Note:</b> If the sensor value exceeds five digits, then the scientific notation E3 is appended to the value on the LCD to signify that the displayed digits are multiplied by 1,000. For example, a value of 100,000 is displayed as 100E3 on the LCD. This only affects the LCD; logged data contains all digits.
	The logger has been configured to start logging on a particular date/time. The display will count down in days, hours, minutes, and seconds until logging begins. In this example, 5 minutes and 38 seconds remain until logging will begin.
	The configure settings are being loaded onto the logger from the app.
	The logger has been stopped with the app or because the memory is full.

**Notes:**

- You can disable the LCD screen when logging. Deselect “Show LCD” when setting up the logger as described in the next section. When this option is disabled, you can still temporarily view the LCD screen by pushing the top or bottom button for 1 second. The LCD will then remain on for 10 minutes.
- The LCD screen refreshes at the same rate as the logging interval.
- When the logger has stopped logging, the LCD screen will remain on with “STOP” displayed until the logger is offloaded to your mobile device (unless the logger was configured with the “Show LCD” option disabled). Once the logger has been offloaded, the LCD will turn off automatically after 1 hour. The LCD will turn back on the next time you press the top or bottom button to wake up the logger.
- The LCD screen flashes “HELLO” when you page the logger from the app (see *Downloading the App and Connecting to a Logger*).
- The LCD screen flashes “BOOT” when a firmware upgrade is underway.
- The LCD screen flashes “CHIRP OFF” when an audible alarm is cleared.

**Button Functionality Quick Reference**

Button	Press for 1 second to:	Press and hold for 3 seconds to:	Press and hold for 10 seconds to:
<b>Top button</b>	<ul style="list-style-type: none"> <li>• Cycle through each channel to view the latest sensor readings</li> <li>• Wake up the logger</li> <li>• Bring the logger to the top of the list in the app</li> <li>• Silence a beeping alarm</li> <li>• Turn on LCD</li> </ul>	Start, stop, or resume logging (depending on settings chosen in the app)	NA

Button	Press for 1 second to:	Press and hold for 3 seconds to:	Press and hold for 10 seconds to:
<b>Bottom button</b>	<ul style="list-style-type: none"> <li>• Cycle through any statistics and alarm readings for the channel currently displayed (if applicable)</li> <li>• Wake up the logger</li> <li>• Silence a beeping alarm</li> <li>• Turn on LCD</li> </ul>	Clear an alarm for the channel currently displayed (depending on the settings chosen in the app)	NA
<b>Both buttons</b>	NA	NA	Reset a password

**Light Measurement (MX1104)**

The MX1104 logger measures light intensity in units of lumens/ft<sup>2</sup> or lux. The light sensor in the MX1104 has a spectral response that tightly matches the photopic response of the human eye. This is shown in Plot A.

The light sensor has range of 0 to 167,731 lux (15,582 lum/ft<sup>2</sup>). The resolution of the light measurement varies from 1 unit of lux or lum/ft<sup>2</sup> in very dim light to 40 lux (4 lum/ft<sup>2</sup>) for a full scale measurement.

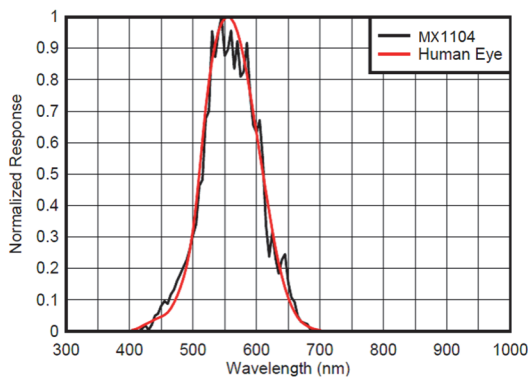

**Plot A**

**Light Measurement Accuracy**

Although the MX1104 is factory calibrated to account for the light attenuation of the plastic enclosure, you may notice a difference in the MX1104 reading compared to a commercially available lux meter. Ideally, a light meter’s response should be proportional to the cosine of the angle at which the light is incident. The MX1104 does not collect light exactly according to this rule. Plot B illustrates the difference between an ideal cosine response and the approximate response of the MX1104. The MX1104 is calibrated to give best results for direct illumination, but this is not always the case.

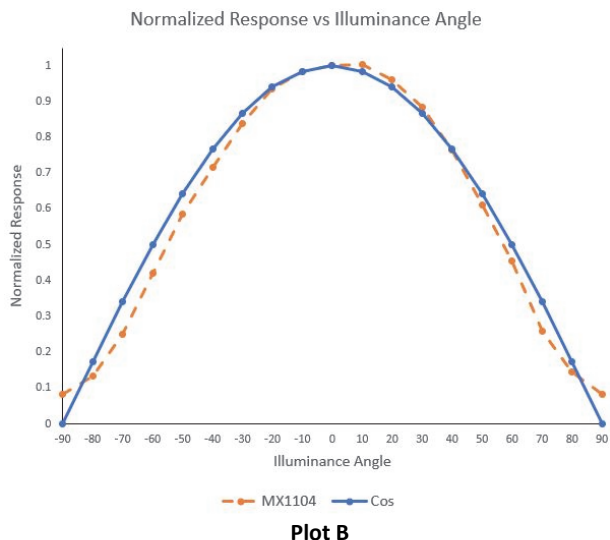

The MX1104 is also calibrated to give best results in the sunlight. Because artificial indoor and outdoor lights have different spectral properties than sunlight, the MX1104 may show an error of greater than ±10% when compared to a commercially available lux meter in these situations. Multiple MX1104 loggers, however, will typically exhibit ±10% agreement with each other in any type of light.

### Downloading the App and Connecting to a Logger

Install the app to connect to and work with the logger.

1. Download HOBObconnect to a phone or tablet from the App Store® or Google Play™. Download the app to a Windows computer from [www.onsetcomp.com/products/software/hobobconnect](http://www.onsetcomp.com/products/software/hobobconnect).
2. Open the app and enable Bluetooth in your device settings if prompted.
3. Press either button on the logger to wake it up.
4. Tap Devices and then tap the logger in the app to connect to it.

If the logger does not appear or if it is having trouble connecting, follow these tips:

- If the logger was configured with Bluetooth Always On disabled (see *Configuring the Logger*), make sure the logger is “awake” by pressing the top or bottom button. Press the top button again to bring the logger to the top of the list if you are working with multiple loggers.
- Make sure the logger is within range of your mobile device or computer. The range for successful wireless communication is approximately 30.5 m (100 ft) with full line-of-sight.
- If your device can connect to the logger intermittently or loses its connection, move closer to the logger, within sight if possible.
- Change the orientation of your device to ensure the antenna is pointed toward the logger. Obstacles between the antenna in the device and the logger may result in intermittent connections.

- If the logger appears in the app, but you cannot connect to it, close the app and then power down your device to force the previous Bluetooth connection to close.

Once the logger is connected, you can:

Tap this:	To do this:
	Select logger settings and save them onto the logger to start logging. See <i>Configuring the Logger</i> .
	Read out (offload) logger data. See <i>Reading Out the Logger</i> .
	Start or restart logging depending on the configuration settings selected in <i>Configuring the Logger</i> .
	Stop the logger from recording data (this overrides any Stop Logging settings described in <i>Configuring the Logger</i> ).
	Make the logger beep one time to help you locate it. “HELLO” also appears on the LCD when the logger is paged.
	Stop a beeping alarm on the logger if audible alarms are enabled as described in <i>Setting up Alarms</i> .
	Set a password for the logger that will be required if another mobile device attempts to connect to it. To reset a password, simultaneously press both the top and bottom button for 10 seconds or tap  and tap Reset.
	Mark the logger as a favorite. You can then filter the list of devices to only show loggers marked as favorites.
	Update the firmware on the logger. A logger readout will be completed automatically at the beginning of the firmware update process

**Important:** Before updating the firmware on the logger, check the remaining battery level and make sure it is no less than 30%. Make sure you have the time to complete the entire update process, which requires that the logger remains connected to the device during the upgrade.

**Note:** Tapping this icon is only required when using the app on an iPhone®, iPad®, or Android device.

### Configuring the Logger

Use the app to set up the logger, including setting alarms, selecting the options to start and stop logging, and choosing a logging mode. These steps provide an overview of setting up the logger. For complete details, see the app user’s guide.

1. If you are using an analog sensor, insert the sensor plug into the sensor port. For self-describing sensors, turn the sensor plug one-quarter clockwise until it stops. See *Working with External Sensors* for more details.
2. In the app, tap Devices. If the logger was configured with Bluetooth Always On disabled, press a button on the logger to wake it up. When working with multiple loggers, you can

press the top button on the logger to bring it to the top of the list.

3. Tap the logger in the app to connect to it and then tap  to configure the logger.
4. Tap Name and type a name for the logger (optional). If no name is selected, the logger serial number is used as the name.
5. Tap Group to add the logger to a group (optional). Tap Save.
6. Tap Logging Interval and choose how frequently the logger will record data unless operating in burst logging mode (see *Burst Logging*).
7. Tap Start Logging and select when logging will begin:
  - **Now.** Logging will begin immediately after the configuration settings are loaded on the logger.
  - **On Next Logging Interval.** Logging will begin at the next even interval as determined by the selected logging interval.
  - **On Button Push.** Logging will begin once you press the Start/Stop logging button on the logger for 3 seconds.
  - **On Date/Time.** Logging will begin at a date and time you specify.
8. Tap Stop Logging and select the options for when logging will end.

Tap Save.

a. Choose one of two memory options:

- **When Memory Fills.** The logger will continue recording data until the memory is full.
- **Never (Wrap When Full).** The logger will continue recording data indefinitely, with newest data overwriting the oldest. This option is not available if the Logging Mode is set to Burst (see *Burst Logging*).

b. Select On Button Push if you want to be able to stop logging by pushing the top button on the logger for 3 seconds.

If you select On Button Push for the Stop Logging option, then you also have the option to select Allow Button Restart. This allows you to stop and then resume logging during the deployment by pushing the top button on the logger for 3 seconds.

**Important:** When Allow Button Restart is selected and you use the top button on the logger to stop and restart logging, logging will restart on the next even logging interval, not at the time the button was pushed. For example, a logger started logging at 7:00 AM with a logging interval set to 1 hour. If you press the top button to stop the logger at 8:45 AM and then press the button again at 10:15 AM, logging will not begin immediately at 10:15 AM. Instead, logging will begin again at 11:00 AM, which is the next even interval time based on your 1-hour logging interval. Therefore, depending on the logging interval, the gap between the time you press the button to resume logging and the time actual logging begins could be significant. The faster the logging interval, the less time will elapse before logging resumes.

c. Select one of the following time options for when to stop logging:

- **Never.** Select this if you do not want the logger to stop at any predetermined time frame.
- **On Date/Time.** Select this if you want the logger to stop logging on a specific date and time. Select the date and time.
- **After.** Select this if you want to control how long the logger should continue logging once it starts. Choose the amount of time you want the logger to log data. For example, select 30 days if you want the logger to log data for 30 days after logging begins.

d. Tap Save.

9. Tap Logging Mode. Select either fixed or burst logging. With fixed logging, the logger records data for all enabled sensors and/or selected statistics at the logging interval selected (see *Statistics Logging* for details on choosing statistics options). In burst mode, logging occurs at a different interval when a specified condition is met. See *Burst Logging* for more information. Tap Save.
10. Enable or disable Show LCD, which controls whether the LCD on the logger will remain illuminated while the logger is logging. If you disable Show LCD, the LCD on the logger will not show the current reading, status, or other information while the logger is logging. You will, however, be able to temporarily turn the LCD screen on by pressing either button on the logger for 1 second. In addition, you can always view the status of any in-range logger on your mobile device regardless of the logger's LCD setting (may require a logger password as applicable).
11. Enable or disable Bluetooth Always On. If Bluetooth Always On is enabled, the logger will "advertise" or regularly send out a Bluetooth signal for the phone, tablet, or computer to find via the app while it is logging, which uses battery power. When Bluetooth Always On is disabled, the logger will only advertise during logging when you press the button on the logger to wake it up, thereby preserving as much battery power as possible.
12. Make sure all channels you want to log are enabled and then do the following:
  - For self-describing sensors, the sensor type will be automatically detected. Tap the sensor if you want to enter a label, set up alarms, or add scaling.
  - For other external sensors, the sensor type will not be automatically detected. Enable the channel (if necessary) and then tap it to enter a label (optional). Select the type of sensor or cable from the list. Set up alarms and add scaling if needed and then tap Save.
  - See *Working with External Sensors* and *Setting up Alarms* for additional details.
13. Tap  to save the configuration settings.

Logging will begin based on the settings you selected. Deploy the logger using the mounting materials (see *Mounting the Logger*). After logging begins, you can read out the logger at any time (see *Reading Out the Logger* for details). **Note:** If an "Error Configuring Logger" message appears in the app, an

error occurred while loading the configure settings onto the logger. Try reconfiguring the logger.

### Working with External Sensors

The MX1104 has one analog sensor port and the MX1105 has four analog sensor ports that can accept self-describing and other external sensors. Refer to [www.onsetcomp.com](http://www.onsetcomp.com) for a current list of supported sensors.

To connect an external sensor:

1. Make sure the logger is stopped.
2. For self-describing sensors, insert the plug into an analog sensor port as shown.

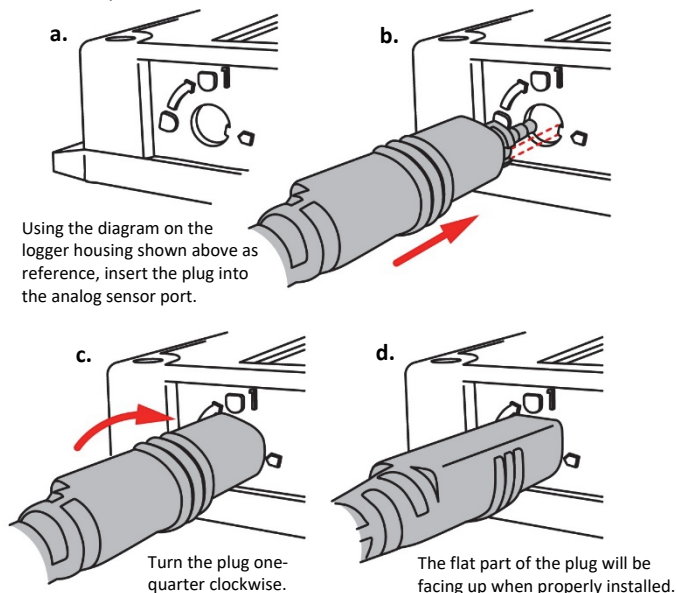

3. For other external sensors, insert the sensor into an analog sensor port and make sure it is firmly seated.
4. If you need to connect a sensor to the sensor cable, complete any wiring before logging begins. Refer to the sensor or cable manual for more information on connecting the sensor and wiring, if applicable.
5. Tap Devices. Press the button on the logger to wake it up (if necessary).
6. Tap the logger in the app to connect to it and tap .
7. Under Sensor & Alarm Setup, make sure all external sensor channels are enabled.
8. For self-describing sensors, the sensor type will be automatically detected. Tap the sensor to enter a label (optional). To set up scaling, tap Scaling and then enter the Series Name, Unit, and values for High and Low and then tap Save. See *Setting up Alarms* for details on adding alarms.

For other external sensors, the sensor type will not be automatically detected. Tap the sensor and enable the channel (if necessary). Enter a label (optional). Select the type of sensor or cable from the list. To set up scaling, tap Scaling and then enter the Series Name, Unit, and values for High and Low and then tap Save. See *Setting up Alarms* for details on adding alarms.

### 9. Tap .

#### Notes:

- For MX1104 loggers, an external sensor is channel 1. For MX1105 loggers, the sensor channel number is listed above the analog sensor port where the external sensor is connected.
- The configuration screen in the app will automatically update to show when a sensor is disconnected or connected.
- Make sure you select the correct sensor type in the app if you are not using self-describing sensors. If you select the wrong type, then incorrect data will be logged. The app can only automatically detect the sensor type for self-describing sensors.
- If you disconnect a sensor or if it is not fully inserted into the analog sensor port while the logger is logging, a warning icon appears on the LCD and the logger will beep once. Use the top button on the logger to view the channel with the warning, which also displays dashes instead of a valid current reading. Erroneous readings will be displayed in the app and logged depending on the logging interval while the sensor is disconnected (e.g. if a sensor is disconnected for 5 minutes and the logging interval is set to 1 minute, then there will be 5 erroneous data points while the sensor was disconnected). When the sensor is reconnected, the warning icon will clear, the correct value will replace the dashes for the channel on the LCD, and the correct readings will be logged.
- Do not swap out sensors or move sensors to empty ports while the logger is logging. Stop the logger before making any physical changes to the sensors.
- If a warning icon appears for a self-describing sensor and you have checked that the correct sensor is properly installed, then the sensor might be faulty. Contact Onset Technical Support.
- The 4-20mA input cable (SD-MA-420 or CABLE-4-20mA) measures current from 0 to 20.1 mA. Do not expose to current above 20 mA or to negative current. Do not cut off the end of the gray cable where it connects to the blue and yellow wires as it contains the precision resistor required for current measurement.
- If you are using the SD-VOLT-2.5 or CABLE-2.5-STEREO voltage input cable, the input line must not be exposed to signals below 0 V or above 2.5 V. The voltage input cable connections are as follows:

Wire	Connection
Red	Switched 2.5 V output
White	Voltage input
Black	Ground

- The external input channels have a switched 2.5 V output. This signal can be used to power a sensor directly or to trigger an external circuit. External sensors should draw no more than 4 mA total when powered.

The switched 2.5 V output turns on about 5 ms before the external channels are measured as shown in the following diagram for an MX1105 logger. The shaded

area shows the 100 ms period for each enabled channel during which the logger samples the input signals.

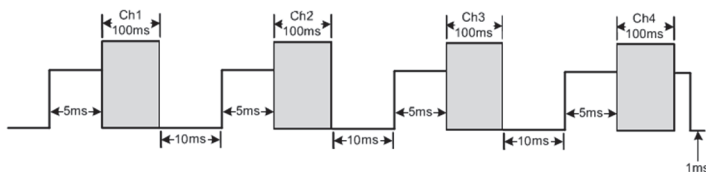

When using multiple voltage and/or current inputs, the (-) from the current source(s) and the 0 V line from the voltage source(s) are tied together at the logger. If these lines are at different voltage potentials, this may cause inaccurate readings or even damage your logger.

**⚠ WARNING:** Analog channel input cannot exceed 2.5 V DC. For sensor outputs up to 24 V DC, use the appropriate voltage adapter cable (SD-VOLT-xx or CABLE-ADAPX).

## Setting up Alarms

You can set an alarm to trip on the logger when a sensor reading rises above or falls below a specified value. This can alert you to problems so you can take corrective action. To set an alarm:

1. Tap Devices. Press the button on the logger to wake it up (if necessary).
2. Tap the logger in the app to connect to it and tap .
3. Tap a sensor (tap the Enable Logging toggle if necessary).
4. Select High if you want an alarm to trip when the sensor reading rises above the high alarm value. Drag the slider or type a value to set the high alarm value.
5. Select Low if you want an alarm to trip when the sensor reading falls below the low alarm value. Drag the slider or type a value to set the low alarm value.
6. For the Duration, select how much time should elapse before the alarm trips and select one of the following:
  - Cumulative. The alarm will trip once the sensor reading is out of the acceptable range for the selected duration any time during logging. For example, if the high alarm is set to 85°F and the duration is set to 30 minutes, then the alarm will trip once the sensor readings have been above 85°F for a total of 30 minutes since the logger was configured.
  - Consecutive. The alarm will trip once the sensor reading is out of the acceptable range continuously for the selected duration. For example, the high alarm is set to 85°F and the duration is set to 30 minutes, then the alarm will only trip if all sensor readings are 85°F or above for a continuous 30-minute period.
7. Tap Save and repeat steps 3–7 for any other sensors if desired.
8. In the configuration settings, enable Audible Alarms if you want a beep to sound on the logger every 30 seconds when the sensor alarm trips. The beeping will continue until the alarm is cleared from the app, either button on the logger is pressed, or 7 days have passed. Battery life will be slightly reduced when this setting is enabled. It is recommended

that you only enable this feature if you have regular access to the logger so that you can easily turn off the beeping.

9. For Maintain Visual Alarms Until, select one of the following options to determine how long the alarm icon will remain illuminated on the logger LCD screen after an alarm trips:

- **Logger Reconfigured.** The alarm icon will remain visible on the LCD until the next time the logger is reconfigured.
- **Sensor in Limits.** The alarm icon will remain visible on the LCD until the sensor reading returns to the normal range between any configured high and low alarm limits.
- **Alarm Button Pressed.** The alarm icon will remain visible until you press the bottom button on the logger.

10. Tap .

### Notes:



- The alarm icon will be illuminated on the logger LCD when the alarm trips. You can also press the bottom button on the logger to view the farthest out-of-range value during the deployment. Dashes will appear instead of a value once the alarm is cleared on the channel. Alarm limits are checked at the same rate as the logging interval.
- The actual values for the high and low alarm limits are set to the closest value supported by the logger. In addition, alarms can trip or clear when the reading is within the resolution specifications. This means the value that triggers the alarm may differ slightly than the value entered.
- When you read out the logger, alarm events can be displayed on the plot or in the data file. See *Logger Events*.
- Once cleared, an audible alarm will start beeping again if the sensor values go out of the normal range. Even if an audible alarm is cleared, a visual alarm may remain on the logger LCD and in the app depending on the settings selected for maintaining visual alarms or because the alarm condition may still be in effect. In addition, an audible alarm will continue beeping when the sensor values have returned to the normal range until it is cleared as described in step 9.
- Although an audible alarm and a visual alarm can occur at the same time when a sensor alarm is tripped, they are cleared in different ways. The audible alarm can be cleared as described in step 9. Meanwhile, a visual alarm is cleared as determined by the setting selected for Maintain Visual Alarm Until configuration setting. This means you could clear a beeping audible alarm and the visual alarm will remain on the LCD and in the app until the logger is reconfigured, the sensor is in limits, or the bottom button on the logger is pressed—whichever setting you selected.
- If the logger was configured to stop logging with a button push, any tripped alarms will be cleared automatically when logging is stopped and no Alarm Cleared event will be logged in the data file. This ensures that the logger will start checking for alarm conditions when logging resumes (if the logger was configured with Allow Button Restart selected).



## Burst Logging

Burst logging is a logging mode that allows you to set up more frequent logging when a specified condition is met. For example, a logger is recording data at a 5-minute logging interval and burst logging is configured to log every 30 seconds for a temperature sensor when the temperature rises above 85°F (the high limit) or falls below 32°F (the low limit). This means the logger will record data every 5 minutes as long as the temperature remains between 32°F and 85°F. Once the temperature rises above 85°F, the logger will switch to the faster logging rate and record data every 30 seconds until the temperature falls back to 85°F. At that time, logging then resumes every 5 minutes at the normal logging interval. Similarly, if the temperature falls below 32°F, then the logger would switch to burst logging mode again and record data every 30 seconds. Once the temperature rises back to 32°F, the logger will then return to normal mode, logging every 5 minutes. **Note:** Sensor alarms, statistics, and the Stop Logging option “Wrap When Full” are not available in burst logging mode.

To set up burst logging:

1. Tap Devices and press the button on the logger to wake it up (if necessary).
2. Tap the logger in the app to connect to it and tap .
3. Tap Logging Mode and then tap Burst Logging.
4. Select Low and/or High and either type or drag the slider to set the low and/or high values.
5. Repeat step 4 for other sensors if desired.
6. Set the burst logging interval, which must be faster than the logging interval. Keep in mind that the more frequent the burst logging rate, the greater the impact on battery life and the shorter the logging duration.
7. Tap Save.
8. Tap .

### Notes:

- Burst limits are checked at the same rate as the logging interval. When the logger enters burst logging mode, the LCD will update at the same rate as the new burst logging interval.
- If high and/or low limits have been configured for more than one sensor, then burst logging will begin when any high or low condition goes out of range. Burst logging will not end until all conditions on all sensors are back within normal range.
- The actual values for the burst logging limits are set to the closest value supported by the logger.
- Burst logging mode can begin or end when the sensor reading is within the resolution specifications. This means the value that triggers burst logging may differ slightly than the value entered.
- Once the high or low condition clears, the logging interval time will be calculated using the last recorded data point in burst logging mode, not the last data point recorded in “normal mode.” For example, let’s assume the logger has a 10-minute logging interval and logged a data point at 9:05. Then, the high limit was surpassed

and burst logging began at 9:06. Burst logging then continued until 9:12 when the sensor reading fell back below the high limit. Now back in normal mode, the next logging interval will be 10 minutes from the last burst logging point, or 9:22 in this case. If burst logging had not occurred, the next data point would have been at 9:15.

- A New Interval event is created each time the logger enters or exits burst logging mode. See *Logger Events* for details on plotting and viewing the event. In addition, if the logger is stopped with a button push while in burst logging mode, then a New Interval event is automatically logged and the burst condition is cleared, even if the actual high or low condition has not cleared. The logger will check the high and low conditions when logging resumes (if the logger was configured with Allow Button Restart selected).

## Statistics Logging

During fixed logging, the logger records data for enabled sensors and/or selected statistics at the logging interval selected. Statistics are calculated at a sampling rate you specify with the results for the sampling period recorded at each logging interval. The following statistics can be logged for each sensor:

- The maximum, or highest, sampled value,
- The minimum, or lowest, sampled value,
- An average of all sampled values, and
- The standard deviation from the average for all sampled values.

For example, the MX1104 logger is configured with only the temperature and RH sensors enabled, and the logging interval set to 5 minutes. The logging mode is set to fixed interval logging with Normal and all four statistics enabled and with a statistics sampling interval of 30 seconds. Once logging begins, the logger will measure and record the actual temperature and RH sensor values every 5 minutes. In addition, the logger will take a temperature and RH sample every 30 seconds and temporarily store them in memory. The logger will then calculate the maximum, minimum, average, and standard deviation using the samples gathered over the previous 5-minute period and log the resulting values. When reading out the logger, this would result in 10 data series (not including any derived series, such as dew point): two sensor series (with temperature and RH data logged every 5 minutes) plus eight maximum, minimum, average, and standard deviation series (four for temperature and four for RH with values calculated and logged every 5 minutes based on the 30-second sampling).

To log statistics:

1. Tap Devices and press the button on the logger to wake it up (if necessary).
2. Tap the logger in the app to connect to it and tap .
3. Tap Logging Mode and then select Fixed Logging.
4. Select Normal to record the current reading for each enabled sensor at the logging interval shown at the top of the screen. Do not select this if you only want to log statistics.



5. Select the statistics you want the logger to record at each logging interval: Maximum, Minimum, Average, and Standard Deviation (average is automatically enabled when selecting Standard Deviation). Statistics will be logged for all enabled sensors. In addition, the more statistics you record, the shorter the logger duration and the more memory is required.
6. Tap Statistics Sampling Interval and select the rate to use for calculating statistics. The rate must be less than, and a factor of, the logging interval. For example, if the logging interval is 1 minute and you select 5 seconds for the sampling rate, then the logger will take 12 sample readings between each logging interval (one sample every 5 seconds for a minute) and use the 12 samples to record the resulting statistics at each 1-minute logging interval. Note that the more frequent the sampling rate, the greater the impact on battery life.
7. Tap Save.
8. Tap .

Once logging begins, click the bottom button on the logger to cycle through the current maximum, minimum, average, and standard deviation data for the current channel displayed on the LCD. Note that the logger will always display the current sensor readings for some channels in the app even if they are not being logged. You can plot the statistics series once you read out the logger.



### Setting a Password

You can create an encrypted password for the logger that will be required if another device attempts to connect to it. This is recommended to ensure that a deployed logger is not mistakenly stopped or purposely altered by others. This password uses a proprietary encryption algorithm that changes with every connection.

To set a password:

1. Tap Devices and press the button on the logger to wake it up (if necessary). Tap the logger in the app to connect to it.
2. Tap  (if applicable) and then .
3. Type a password and then tap Set.



Only the device used to set the password can then connect to the logger without entering a password; all other devices will be required to enter the password. For example, if you set the password for the logger with your tablet and then try to connect to the logger later with your phone, you will be required to enter the password on the phone but not with your tablet. Similarly, if others attempt to connect to the logger with different devices, then they would also be required to enter the password. To reset a password, press the button on the logger

for 10 seconds or connect to the logger and tap  (if applicable), then , and tap Reset.

### Reading Out the Logger

To offload data from the logger:

1. Tap Devices and press the button on the logger to wake it up (if necessary).



2. Tap the logger in the app to connect to it and tap . The logger will read out the data to the phone, tablet, or computer.
3. Once the readout is complete, tap HOBO Files and select the file to view it. Tap  (if applicable) and  to export the data.

Data can also be uploaded automatically to HOBOLink, Onset’s web-based software, via the app or the MX gateway. For details, see the app user’s guide and see the HOBOLink help for details on working with data in HOBOLink.

### Logger Events

The logger records the following internal events to track logger operation and status. You can view events in exported files or plot events in the app.

To plot events, tap HOBO Files and select a file to open.

Tap  (if applicable) and then tap . Select the events you want to plot and tap OK.

Internal Event Name	Definition
Host Connected	The logger was connected to the mobile device.
Started	The top button on the logger was pressed to begin or resume logging.
Stopped	The logger received a command to stop recording data (from the app or by pushing the top button on the logger).
Chan <#> Alarm Tripped	A sensor alarm has tripped; <#> is the sensor number, 1 through 4.
Chan <#> Alarm Cleared	A sensor alarm has cleared; <#> is the sensor number, 1 through 4. This event also contains the value that was furthest out of range for the sensor before the alarm cleared, which is only available in a shared or exported file.
New Interval	The logger has entered or exited burst logging mode.
Safe Shutdown	The battery level dropped below 1.6 V; the logger performs a safe shutdown.

### Mounting the Logger

Use the four magnets on the back of the logger to mount it to a magnetic surface or insert the tie wraps through the mounting loops to attach it to other surfaces. Insert a Santoprene plug into any empty analog sensor ports if necessary.

### Protecting the Logger

The logger is designed for indoor use and can be permanently damaged by corrosion if it gets wet. Protect it from condensation.

**Note: Static electricity may cause the logger to stop logging.**

The logger has been tested to 8 KV, but avoid electrostatic discharge by grounding yourself to protect the logger. For more information, search for “static discharge” on onsetcomp.com.

## Battery Information

The logger requires two user-replaceable AAA 1.5 V alkaline or optional lithium batteries for operation at the extreme ends of the logger operating range. Battery life is 1 year, typical with a logging interval of 1 minute, but may be extended to 2 years when the logger is configured with Bluetooth Always On disabled. Expected battery life varies based on the ambient temperature where the logger is deployed, the logging or sampling interval, frequency of offloading and connection to the mobile device, number of channels that are active, audible alarms duration, use of burst mode or statistics logging, and battery performance. Deployments in extremely cold or hot temperatures, a logging interval faster than 1 minute, or a sampling interval faster than 15 seconds can impact battery life. Estimates are not guaranteed due to uncertainties in initial battery conditions and operating environment.

To replace the batteries:

1. Use a Phillips-head screwdriver to unscrew the four screws on the front of the logger.
2. Carefully separate the top and bottom of the logger enclosure.
3. Remove any old batteries and insert new batteries observing polarity.

4. Make sure the rubber seal on the bottom part of the logger enclosure is clean and free of any debris.
5. Carefully reassemble the logger enclosure and screw in the four screws.

**⚠ WARNING:** Do not cut open, incinerate, heat above 85°C (185°F), or recharge lithium batteries. The batteries may explode if the logger is exposed to extreme heat or conditions that could damage or destroy the battery cases. Do not dispose of the logger or batteries in fire. Do not expose the contents of the batteries to water. Dispose of the batteries according to local regulations for lithium batteries.

### Federal Communication Commission Interference Statement

This equipment has been tested and found to comply with the limits for a Class B digital device, pursuant to Part 15 of the FCC Rules. These limits are designed to provide reasonable protection against harmful interference in a residential installation. This equipment generates uses and can radiate radio frequency energy and, if not installed and used in accordance with the instructions, may cause harmful interference to radio communications. However, there is no guarantee that interference will not occur in a particular installation. If this equipment does cause harmful interference to radio or television reception, which can be determined by turning the equipment off and on, the user is encouraged to try to correct the interference by one of the following measures:

- Reorient or relocate the receiving antenna
- Increase the separation between the equipment and receiver
- Connect the equipment into an outlet on a circuit different from that to which the receiver is connected
- Consult the dealer or an experienced radio/TV technician for help

This device complies with Part 15 of the FCC Rules. Operation is subject to the following two conditions: (1) This device may not cause harmful interference, and (2) this device must accept any interference received, including interference that may cause undesired operation.

**FCC Caution:** Any changes or modifications not expressly approved by the party responsible for compliance could void the user's authority to operate this equipment.

### Industry Canada Statements

This device complies with Industry Canada license-exempt RSS standard(s). Operation is subject to the following two conditions: (1) this device may not cause interference, and (2) this device must accept any interference, including interference that may cause undesired operation of the device.

### Avis de conformité pour l'Industrie Canada

Le présent appareil est conforme aux CNR d'Industrie Canada applicables aux appareils radio exempts de licence. L'exploitation est autorisée aux deux conditions suivantes : (1) l'appareil ne doit pas produire de brouillage, et (2) l'appareil doit accepter tout brouillage radioélectrique subi, même si le brouillage est susceptible d'en compromettre le fonctionnement.

To comply with FCC and Industry Canada RF radiation exposure limits for general population, the logger must be installed to provide a separation distance of at least 20cm from all persons and must not be co-located or operating in conjunction with any other antenna or transmitter.

### KC Statement

해당 무선설비는 전파혼신 가능성이 있으므로 인명안전과 관련된 서비스는 할 수 없음

### Translation:

The service related to human safety is not allowed because this device may have the possibility of the radio interference.