



oxy.IQ

Panametrics oxygen analyzer

User's manual

oxy.IQ

Panametrics oxygen analyzer

User's manual

910-296 rev. F
September 2020

[no content intended for this page]

Contents

Product registration	vii
Services	vii
Terms and conditions	vii
Typographical conventions	vii
Auxiliary equipment	viii
Regulatory compliance	viii
Chapter 1. Features and capabilities	1
1.1 Introduction	1
1.2 Hazardous location certifications	1
1.3 Applications	2
1.4 Features	2
1.5 Sample systems	2
Chapter 2. Installation	3
2.1 Mounting the oxy.IQ	3
2.2 Wiring the oxy.IQ	4
2.2.1 Longer cable lengths	4
2.3 Installing an oxygen sensor	5
Chapter 3. Initial setup and operation	6
3.1 The oxy.IQ display and keypad	6
3.2 The oxy.IQ menu map	6
3.3 Adjusting and calibrating the oxy.IQ	7
3.3.1 Selecting the output range	7
3.3.2 Trimming the analog output	7
3.3.3 Air calibration	8
3.3.4 Span gas calibration	8
Chapter 4. User programming	9
4.1 Introduction	9
4.2 The calibration menu	9
4.2.1 Air	9
4.2.2 Span gas	9
4.2.3 Sensor life	9
4.3 The display menu	10
4.3.1 Select the O ₂ parameter	10
4.3.2 Display the sensor range	10
4.3.3 Adjust the contrast	10

- 4.4 The output menu 11**
 - 4.4.1 Range.....11
 - 4.4.2 Trim11
 - 4.4.3 Error type.....11
 - 4.4.4 Error output11

- Chapter 5. The service menu 12**
 - 5.1 Menu map and service passcode12**
 - 5.2 Entering the service menu12**
 - 5.2.1 Diagnostics12

- Chapter 6. Specifications 13**
 - 6.1 Intrinsically safe (IS) installation13**
 - 6.2 Non-incendive (div 2) and general purpose installation.....13**
 - 6.3 All installations 14**
 - 6.4 Product label 14**

- Appendix A. Outline and installation drawings 15**

- Appendix B. Menu maps21**

- Appendix C. Order string..... 25**

Product registration

Thank you for purchasing a model oxy.IQ from Panametrics. Please register your product at <https://info.bakerhughes.com/New-Product-Registration-LP.html> for product support such as the latest software/firmware upgrades, product information and special promotions.

Services

Panametrics provides customers with an experienced staff of customer support personnel ready to respond to technical inquiries, as well as other remote and on-site support needs. To complement our broad portfolio of industry-leading solutions, we offer several types of flexible and scalable support services including: training, product repairs, extended warranties, service agreements and more. Please visit www.gemeasurement.com/services for more details.

Terms and conditions

Panametrics' sales terms and conditions for your recent purchase of a Panametrics product, including the applicable product warranty, can be found on our website at the following link: <https://www.bakerhughesds.com/sales-terms-conditions>

Typographical conventions

Note: These paragraphs provide information that provides a deeper understanding of the situation, but is not essential to the proper completion of the instructions.

IMPORTANT: These paragraphs provide information that emphasizes instructions that are essential to proper setup of the equipment. Failure to follow these instructions carefully may cause unreliable performance.



CAUTION!

This symbol indicates a risk of potential minor personal injury and/or severe damage to the equipment, unless these instructions are followed carefully.



WARNING!

This symbol indicates a risk of potential serious personal injury, unless these instructions are followed carefully.

Safety issues



WARNING!

It is the responsibility of the user to make sure all local, county, state and national codes, regulations, rules and laws related to safety and safe operating conditions are met for each installation.



Attention European customers!



To meet CE marking requirements for all units intended for use in the EU, all electrical cables must be installed as described in this manual.

Auxiliary equipment

Local safety standards

The user must make sure that he/she operates all auxiliary equipment in accordance with local codes, standards, regulations, or laws applicable to safety.

Working area

	<p>WARNING!</p> <p>Auxiliary equipment may have both manual and automatic modes of operation. As equipment can move suddenly and without warning, do not enter the work cell of this equipment during automatic operation, and do not enter the work envelope of this equipment during manual operation. If you do, serious injury can result.</p>
	<p>WARNING!</p> <p>Make sure that power to the auxiliary equipment is turned OFF and locked out before you perform maintenance procedures on this equipment.</p>

Qualification of personnel

Make sure that all personnel have manufacturer-approved training applicable to the auxiliary equipment.

Personal safety equipment

Make sure that operators and maintenance personnel have all safety equipment applicable to the auxiliary equipment. Examples include safety glasses, protective headgear, safety shoes, etc.

Unauthorized operation

Make sure that unauthorized personnel cannot gain access to the operation of the equipment.

Regulatory compliance

Waste Electrical and Electronic Equipment (WEEE) directive

Panametrics is an active participant in Europe's Waste Electrical and Electronic Equipment (WEEE) take-back initiative (directive 2012/19/EU).



The equipment that you bought has required the extraction and use of natural resources for its production. It may contain hazardous substances that could impact health and the environment.

In order to avoid the dissemination of those substances in our environment and to diminish the pressure on the natural resources, we encourage you to use the appropriate take-back systems. Those systems will reuse or recycle most of the materials of your end life equipment in a sound way. The crossed-out wheeled bin symbol invites you to use those systems.

If you need more information on the collection, reuse and recycling systems, please contact your local or regional waste administration. Visit <https://www.bakerhughesds.com/health-safety-and-environment-hse> for take-back instructions and more information about this initiative.

RoHS

The oxy.IQ fully complies with RoHS regulations (directive 2011/65/EU).

Chapter 1. Features and capabilities

1.1 Introduction

The **oxy.IQ Panametrics oxygen transmitter** (see figure 1 below) is a highly reliable and cost-effective two-wire, loop-powered transmitter with a linearized 4 to 20 mA output. It measures oxygen content in ten ppm ranges (10, 20, 50, 100, 200, 500, 1000, 2000, 5000 and 10000 ppm) and eight percentage ranges (1, 2, 5, 10, 21, 25, 50 and 100%). All ranges are user-selectable. This compact transmitter uses proven sensor technology to accurately measure oxygen content in a variety of gases, even in hazardous (classified) locations.



Figure 1: oxy.IQ

1.2 Hazardous location certifications

When equipped with an optional *Zener barrier* or *galvanic isolator*, the oxy.IQ can be mounted in a hazardous (classified) location. The oxy.IQ with *intrinsically safe* option is certified to USA, Canadian, ATEX, and international IECEx IS requirements. The standard oxy.IQ is certified to USA, Canadian, EU ATEX and International IECEx div2/Zone 2 non-incendive requirements.

1.3 Applications

Some typical applications for the oxy.IQ Panametrics oxygen transmitter include the following:

- Glove box purge and leak detection
- Natural gas
- Semiconductor wafer machines
- Coating process machines
- Membrane air separators
- Inert welding gases
- Pure gaseous hydrocarbon streams
- Process monitoring of gaseous monomers
- Heat treating and bright annealing

1.4 Features

The oxy.IQ oxygen sensor uses an advanced galvanic fuel cell that provides superior performance, accuracy, stability and long life. The cell's innovative design eliminates the potential for negative signal output and reduces sources of contamination.

The cell is unaffected by other background gases or hydrocarbons and is compatible with acidic gases (**OX-2** and **OX-4** cells). Recovery from air at low ppm levels takes just a few minutes. Because the cell is self-contained, minimal maintenance is required. There is no electrolyte to change and no electrodes to clean.

The oxy.IQ offers the following features:

- Two-wire, loop-powered, 4 to 20 mA transmitter
- Display with keypad
- Intrinsically-safe option
- Proven galvanic fuel cell O₂ sensor technology
- User-selectable ranges for ppm and percent oxygen
- User-friendly and intuitive user interface with diagnostics
- Microprocessor-based, all-digital technology for reliable operation
- Low maintenance, economical and compact
- Sensor failure output error
- Sensor lifetime indication
- NAMUR error indication

1.5 Sample systems

In addition to the standard features and options, Panametrics offers a full line of sample handling systems for a variety of applications. If needed, Panametrics can design and build a sample conditioning system to meet unique application requirements. Please contact Panametrics for details.

Table 1 below lists some background gases that can interfere with the oxygen sensor.

Table 1: Oxygen sensor interference gases						
Gas	OX-1 and 5 ppm	OX-2 ppm	OX-3 %		OX-4 %	
	Cont.	Cont.	Cont.	Int. (1)	Cont.	Int.
H ₂ S	<5 ppm	<10 ppm	0.0005%	0.01%	0.001 %	0.1 %
SO ₃	<10 ppm	<10 ppm	0.01%	0.1%	0.01 %	0.1 %
SO ₂	<10 ppm	(3)	0.01%	0.1%	(3)	(3)
HCl	<1000 ppm	(3)	0.1%	1.0%	(3)	(3)
HCN	<1000 ppm	(3)	0.1%	1.0%	(3)	(3)
CO ₂	<1000 ppm	(3)	0.1%	20	(3)	(3)
NO ₂	(2)	(2)	(2)	(2)	(2)	(2)
Cl ₂	(2)	(2)	(2)	(2)	(2)	(2)

Cont. = Continuous, Int. = intermittent

(1) Recommended maximum exposure 30 minutes, followed by flushing with ambient air for an equal period.

(2) Minimal effect on sensor performance, but produces signal interference of 1:2 ratio for ppm levels only (e.g., 100 ppm NO₂ looks like 200 ppm O₂).

(3) Minimal effect on sensor performance

Chapter 2. Installation

2.1 Mounting the oxy.IQ

To install the oxy.IQ into the process or sample system, refer to figure 9 and/or figure 2 below and proceed to the next page.

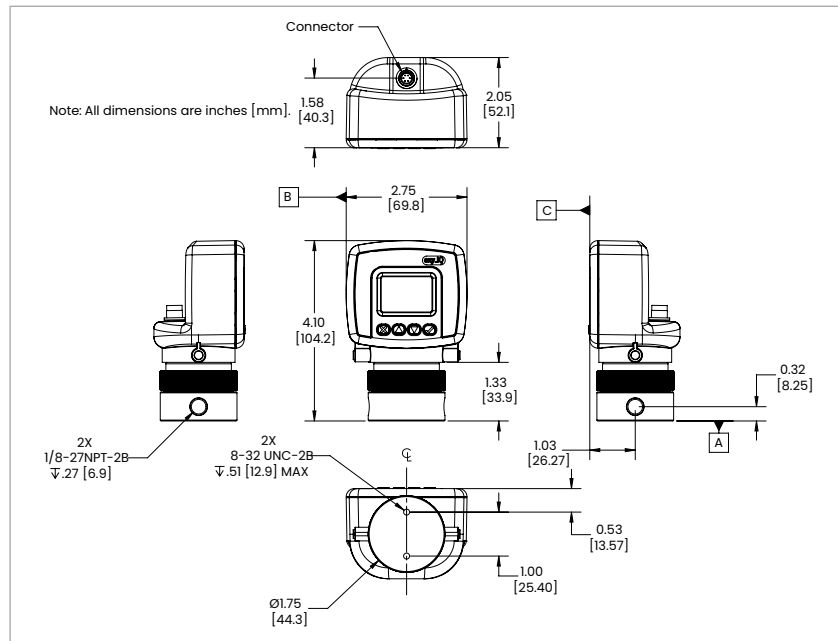

Figure 2: Outline and dimensions (ref. dwg. 712-1840)

Note: To avoid collecting condensate that may damage the oxygen sensor, mount the oxy.IQ in an upright position, with the sensor manifold below the electronics module.

Install the oxy.IQ by completing the following steps:

1. Remove the oxy.IQ and the separately-packaged oxygen sensor (see figure 3 below) from the shipping container. Keep the shipping container and packaging material for possible future use.

IMPORTANT:

DO NOT open the oxygen sensor package until you are ready to install the sensor.

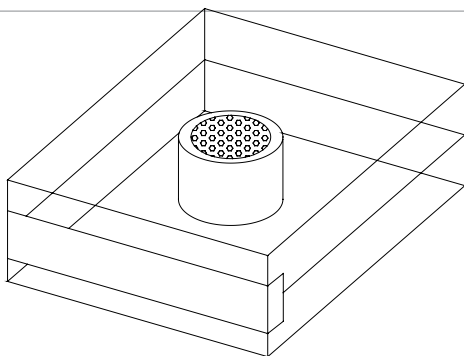

Figure 3: Packaged oxygen sensor

2. Remove the sensor manifold by unscrewing it from the blue knurled nut on the sensor base at the bottom of the electronics module.

IMPORTANT:

The maximum operating sample pressure for the oxy.IQ is 10 psig except when the ambient air adapter is used for the sample manifold. The burst pressure of the sample manifold is 200 psig for all bases except the ISO KF-40 flange adapter. Since this option is designed for a vacuum flange it cannot handle sample pressure greater than 20 psig. Be sure the sample conditioning system is designed to maintain the oxy.IQ pressure below these limits, and that the oxy.IQ outlet is vented to atmosphere during operation and calibration.

3. Using PTFE tape as a sealant, connect the sample gas inlet and outlet to the 1/8" NPT ports on the sensor manifold (see figure 4 below). Either port may be used as the inlet or the outlet, as the direction of flow does not matter.

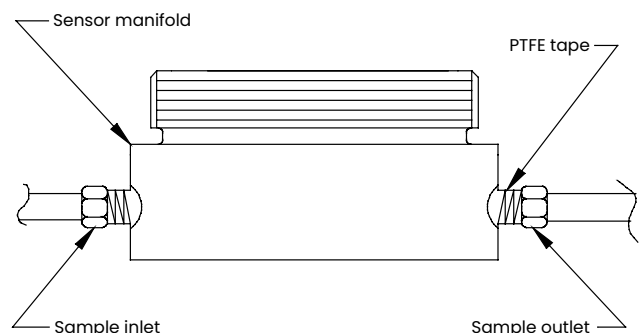

Figure 4: Sensor manifold installation

2.2 Wiring the oxy.IQ

To wire the oxy.IQ, refer to figure 14, then proceed as follows:



WARNING!

For IS (intrinsically safe) applications, the oxy.IQ must be installed with a Zener barrier (see the top of figure 14). Also, for installations in a hazardous location, the blue IS cable (p/n 704-1318-02, 10) must be used.

1. Attach the appropriate cable to the oxy.IQ (see figure 5 below). Be sure to align the white arrow on the cable connector with the white arrow on the oxy.IQ connector, and then push the top of the cable connector straight down onto the mating connector on the rear of the electronics module until you hear it click into place.

IMPORTANT:

Do not rotate the cable connector during installation (it is not threaded) and do not hold the connector by its bottom section while pushing it down into place.

IMPORTANT:

To remove the cable, grasp the bottom section of the connector (the part with the white arrow) and pull it straight up until the cable comes loose. **DO NOT** twist the connector either by hand or with any tool during removal.

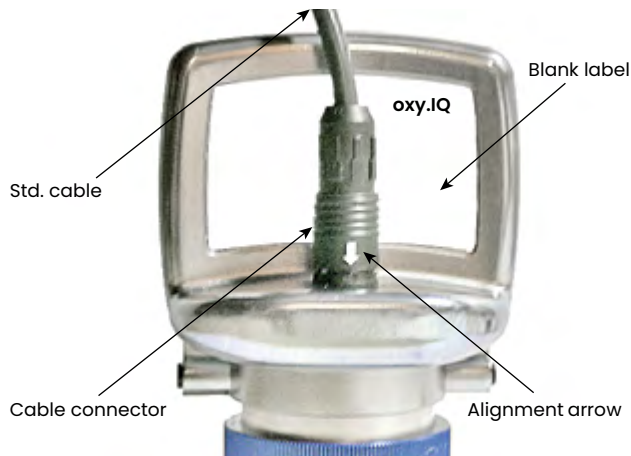

Figure 5: oxy.IQ cable and connector

2. Connect the flying lead end of the cable as shown in the wiring diagram, according to one of the following conditions:

- **No Zener barrier or galvanic isolator:**
 - For use in non-hazardous areas or div 2 hazardous areas.
- **With Zener barrier or galvanic isolator:**
 - Required for use in hazardous areas.

IMPORTANT:

To remove the cable from the oxy.IQ electronics module, simply pull straight up on the lower section of the cable connector as close to the oxy.IQ body as possible. Do not pull on the cable or the upper portion of the cable connector, and do not try to unscrew the cable connector.

2.2.1 Longer cable lengths

Panametrics offers cables in 2 m and 10 m standard lengths. Longer cable lengths may be used with the oxy.IQ, but these are not available from Panametrics. If you require a longer cable, refer to the following figures for the required cable specifications and construct your own cable for splicing onto the standard Panametrics cable:

- **Standard cable:** figure 10 and figure 11.
- **IS cable:** figure 12 and figure 13.

2.3 Installing an oxygen sensor

To install a new or replacement oxygen sensor in the oxy.IQ, refer to figure 6 below and complete the following steps:

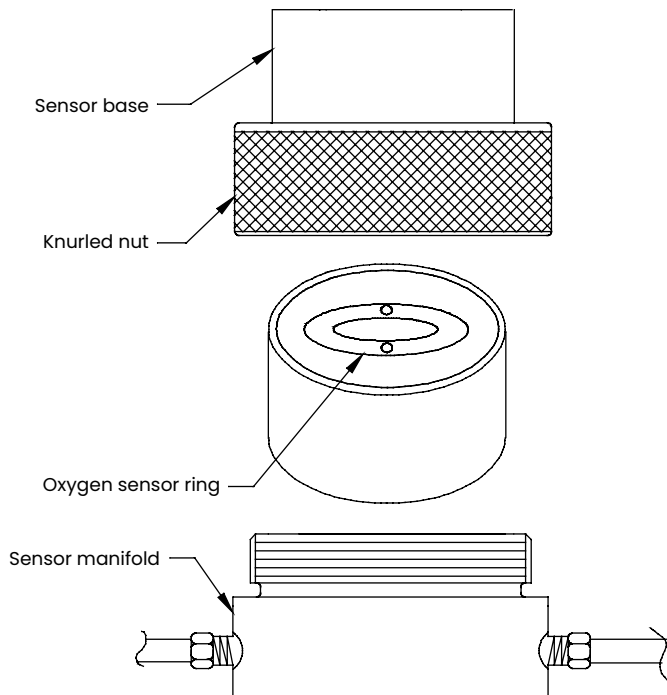

Figure 6: Oxygen sensor installation

1. Disconnect the power from the oxy.IQ.
2. Loosen the blue knurled nut and remove the oxy.IQ electronics module from the sensor manifold. If a previous oxygen sensor is already in place, remove and discard it.
3. Apply power to the unit. The screen will display **"INITIALIZING PLEASE WAIT"** for a few seconds before it begins to display measurement data.

Note: Before continuing with the installation, become familiar with the procedures for programming and calibrating the oxy.IQ discussed in chapter 3, initial setup and operation.

4. Trim the 4-20 mA analog output and set the range to 0-25% oxygen.
5. Open the airtight package (see figure 3) and remove the oxygen sensor from the package. To maintain the oxygen sensor's energy level, remove the red grounding tab and **immediately** install the sensor in the oxy.IQ
6. Orient the sensor so that its gold-plated electrodes are facing the spring-loaded contact pins in the sensor base (see figure 6). Firmly press the oxygen sensor into the sensor base at the bottom of the oxy.IQ electronics module.

7. Perform an air calibration on the new oxygen sensor at this time. On the 0-25% oxygen scale, a properly calibrated oxygen sensor shows a reading of 20.9% on the display and generates a current of 17.4 mA at the 4-20 mA analog output terminals.
8. Using the blue knurled nut, attach the oxy.IQ electronics module with the calibrated oxygen sensor to the sensor manifold. Rotate the display as desired and then hand-tighten the blue knurled nut.

IMPORTANT:

Make sure that the o-ring on the top of the sensor manifold is in place and undamaged. If necessary, contact Panametrics for a replacement.

9. Begin the flow of the process gas. The analog output reading will drop as the oxygen sensor adjusts to the reduced oxygen level. During this time, reset the range as required.
10. For improved accuracy in the ppm oxygen ranges, a span gas calibration should now be performed (see *"span gas calibration"*).

IMPORTANT:

Sensor life is dependent on the application. High oxygen concentrations and contaminants such as acidic gases will shorten the sensor life.

Chapter 3. Initial setup and operation

3.1 The oxy.IQ display and keypad

All programming of the oxy.IQ is done via the front panel keypad and display, as illustrated below.



Figure 7: oxy.IQ display and keypad

The front panel components perform the following functions:

- **Display** - data measurements and the programming menus and options are shown on the LCD display screen.
- **✓ Enter** - While in measurement mode, press this key to enter the *main menu*. While in the *main menu*, press this key to save an entry and advance to the next screen.
- **✕ Cancel** - While in the *main menu*, press this key to cancel an entry and to return to the previous screen.
- **▲ and ▼ keys** - in the *main menu*, use these keys to move the cursor between rows one row at a time in the direction indicated.

3.2 The oxy.IQ menu map

As an aid in navigating through the *main menu*, a complete *menu map* of the user program is shown in figure 16. Refer to this figure as needed while programming the oxy.IQ.

The oxy.IQ *main menu* consists of the following submenus:

- *Calibration menu* (no passcode required)
- *Display menu* (no passcode required)
- *Output menu* (no passcode required)
- *Service menu* (factory service passcode required)

To enter the *main menu* from normal display mode, simply press the **✓ enter** key at any time. To leave the *main menu* and return to measurement mode, press the **✕ cancel** key.

Note: Depending on how deep you are in the menu structure, it may be necessary to press the **✕ cancel** key more than once to return all the way back to measurement mode.

3.3 Adjusting and calibrating the oxy.IQ

Upon startup, the following five-step adjustment and calibration procedure must be performed on the oxy.IQ:

1. Select the desired output range.
2. Trim the low (4 mA) and high (20 mA) analog outputs.
3. Upon installation of a new oxygen sensor, calibrate the unit with air for either a ppm or % sensor.
4. For ppm sensors only, purge the sensor with a low ppm oxygen gas.
5. For all subsequent calibrations, use a span gas that is appropriate for the sensor and range selected.

3.3.1 Selecting the output range

To select the desired measurement range, complete the following steps:

1. Press the **enter** key to enter the *main menu*.
2. Press the **▼** key twice and then press the **enter** key to enter the *output menu*.
3. Press the **enter** key to select the *range menu* option.
4. Use the **▲** and **▼** keys to scroll through the available options, as listed in table 2 below.

Table 2: Available output ranges

Units	Span value
% O ₂	1, 2, 5, 10, 21, 25, 50, 100
ppm O ₂	10, 20, 50, 100, 200, 500, 1000, 2000, 5000, 10000

5. After selecting the desired output range, press the **enter** key to save the selection. Then, press the **cancel** key to return to the *output menu*.

3.3.2 Trimming the analog output

To trim the analog output, calibrate the low (4 mA) end of the output then the high (20 mA) end of the output.

IMPORTANT:

The 4 mA and 20 mA adjustments interact with each other. Therefore, recheck the trim after the procedure has been completed.

3.3.2a Preparing to trim the analog output

Prepare to trim the analog output as follows:

1. Connect an ammeter in series with the positive oxy.IQ power supply lead, to monitor the analog output current.
2. Press the **enter** key to enter the *main menu*.
3. Press the **▼** key twice and then press the **enter** key to enter the *output menu*.
4. Press the **▼** key and then press the **enter** key to enter the *trim menu*.

3.3.2b Trimming the analog output low (4 mA) end

Prepare to trim the analog output as follows:

1. Press the **enter** key to enter the 4 mA *trim menu*, and the analog output is driven to about 4 mA.
2. Use the **▲** and **▼** keys to adjust the analog output up or down, until it equals 4.00 ± 0.01 mA.
3. Press the **enter** key to save the trim adjustment and return to the *trim menu*.

3.3.2c Trimming the analog output high (20 mA) end

1. Press the **▼** key and then press the **enter** key to enter the 20 mA *trim menu*, and the analog output is driven to about 20 mA.
2. Use the **▲** and **▼** keys to adjust the analog output up or down, until it equals 20.00 ± 0.01 mA.
3. Press the **enter** key to save the trim adjustment and return to the *trim menu*.

3.3.2d Completing the trim procedure

1. Repeat both the low (4 mA) end and high (20 mA) end analog output trimming steps until no further trimming adjustments are required.
2. Press the **cancel** key twice to return to the *main menu*.

3.3.3 Air calibration

An air calibration is always recommended upon installation of a new oxygen sensor. However, because of the non-linearity of the oxygen sensor, a span gas calibration (see the next section) can also be performed to ensure a faster and more accurate calibration for the ppm ranges.



CAUTION!

The useful life of ppm sensors is extended by minimizing exposure of the sensor to air.

To perform an air calibration, complete the following steps:

1. Press the **enter** key to enter the *main menu*.
2. Press the **enter** key to enter the *calibration menu*.
3. Press the **enter** key to select the *air menu* option.

Proceed to the appropriate section, depending on whether you are calibrating a new sensor or recalibrating an existing sensor.

3.3.3a Calibrating a new sensor

For a new sensor, continue the air calibration procedure as follows:

1. Press the **down arrow** key and then press the **enter** key to select the *YES menu* option.
2. Press the **enter** key to acknowledge that you are resetting the *sensor lifetime clock*.
3. As instructed, remove the sensor manifold to expose the new oxygen sensor to ambient air for about two minutes. Then, press the **enter** key to continue.
4. A message indicating that the calibration is in progress will be displayed, and then the calibration data will be shown. At that time, press the **enter** key to save the calibration data and return to measurement mode.

Note: A second calibration of the new sensor should be performed within 1-2 days of the first calibration.

3.3.3.3b Recalibrating an existing sensor

For an existing sensor, continue the air calibration procedure as follows:

1. Press the **enter** key to select the *NO menu* option.
2. As instructed, remove the sensor manifold to expose the oxygen sensor to ambient air for about two minutes. Then, press the **enter** key to continue.
3. A message indicating that the calibration is in progress will be displayed, and then the calibration data will be shown. At that time, press the **enter** key to save the calibration data and return to measurement mode.

3.3.4 Span gas calibration

Before beginning the span gas calibration, make sure the *oxy.IQ* is indicating an O_2 level less than the span gas value, to ensure an accurate calibration. Then, start the flow of the span gas to the sensor. For accurate calibration, the span gas should have an oxygen content of 70-90% of the range being calibrated.

To perform the span calibration, complete the following steps:

1. Use the equation below to calculate the expected mA output that corresponds to the known oxygen content of the span gas:

$$4.0 + 16.0 \times \frac{\text{span gas ppm}}{\text{full range ppm}} = \text{mA output}$$

For example, if the span gas contains 80 ppm oxygen and the 0-100 ppm range is being calibrated, the analog output should equal $4 + 16 \times (80/100) = 16.8$ mA.

2. If you have not done so already, start the flow of span gas to the sensor and allow both the 4-20 mA output reading and the display reading to stabilize.
3. After the reading has stabilized, press the **enter** key to enter the *main menu*.
4. Press the **enter** key to enter the *calibration menu*.
5. Press the **down arrow** key and then press the **enter** key to select the *span gas menu* option.
6. Press the **up arrow** and **down arrow** keys until the measurement agrees with the span calibration gas value.
7. Confirm that the reading on the display has stabilized, and press the **enter** key to save the calibration. Then, press the **cancel** key twice to return to measurement mode.

Chapter 4. User programming

4.1 Introduction

IMPORTANT:

The *oxy.IQ service menu* is for use by qualified service personnel only and requires a special passcode for access. That menu is not discussed in this chapter.

This chapter provides instructions for programming all of the *oxy.IQ* menu options available to the user, which can be accessed without the use of a passcode. These menu options are found in the following main menu submenus:

- *Calibration menu*
- *Display menu*
- *Output menu*

While programming these menus, refer to the menu map in figure 16.

Note: The menu options for initial setup are described in chapter 3, Initial setup and operation, and are only referenced in this chapter.

4.2 The calibration menu

Proceed to the appropriate section to program the desired menu option.

4.2.1 Air







See "*air calibration*."

4.2.2 Span gas

See "*span gas calibration*."

4.2.3 Sensor life

To read the sensor life, complete the following steps:







1. Press the  **enter** key to enter the *main menu*.
2. Press the  **enter** key to enter the *calibration menu*.
3. Press the  key three times and then press the  **enter** key to enter the *sensor life menu*.
4. The number of days your sensor has been in use is displayed. When you have finished reading the information, press the  **enter** key to return to the *calibration menu*.
5. Press the  **cancel** key twice to return to measurement mode.

4.3 The display menu

Proceed to the appropriate section to program the desired menu option.









4.3.1 Select the O₂ parameter

To select the O₂ parameter for display, complete the following steps:

1. Press the  **enter** key to enter the *main menu*.
2. Press the  key once and then press the  **enter** key to enter the *display menu*.
3. Press the  **enter** key to enter the *O₂ menu*.
4. Use the  and  keys to select the desired O₂ range to be displayed:
 - ppm only
 - % only
 - Auto select
(automatically displays the appropriate range)
5. Press the  **enter** key to confirm your choice and return to measurement mode.







4.3.2 Display the sensor range

To select whether or not the O₂ range of the installed sensor is displayed, complete the following steps:

1. Press the  **enter** key to enter the *main menu*.
2. Press the  key once and then press the  **enter** key to enter the *display menu*.
3. Press the  key once and then press the  **enter** key to enter the *display range menu*.
4. Use the  and  keys to select the desired option:
 - On - the O₂ range is displayed at the bottom of the screen
 - Off - the O₂ range is not displayed at the bottom of the screen
5. Press the  **enter** key to confirm your choice and return to measurement mode.

4.3.3 Adjust the contrast

To adjust the display contrast, complete the following steps:

1. Press the  **enter** key to enter the *main menu*.
2. Press the  key twice and then press the  **enter** key to enter the *contrast menu*.
3. Use the  and  keys to adjust the contrast to the desired value, then press the  **enter** key to save the new value.
4. Press the  **cancel** key twice to return to measurement mode.

4.4 The output menu

Proceed to the appropriate section to program the desired menu option.

4.4.1 Range

See "selecting the output range."

4.4.2 Trim

See "trimming the analog output."

4.4.3 Error type

To select the process conditions that will activate an on-screen warning and send an alarm to the analog output device, complete the following steps:

1. Press the **enter** key to enter the *main menu*.
2. Press the **▼** key twice and then press the **enter** key to enter the *output menu*.
3. Press the **▼** key twice and then press the **enter** key to enter the *error type menu*.
4. Use the **▲** and **▼** keys to select the desired option and then press the **enter** key to activate that error type. A check mark will appear next to the selected option to indicate that it is activated. The following options are available, and you may activate as many of these options as you wish.

Note: Only the first four options are displayed on the screen upon entering this menu. When you scroll down to the fourth option (low temp), a down arrow to the right of this option indicates that an additional screen of options is available.

- High O₂ (Fixed value of >25%, regardless of selected range)
- Low O₂ (programmable)
- High temp
- Low temp (programmable)
- Temp comp (listed on second screen of options)

Note: Pressing the **enter** key on an error type that has already been activated, will deactivate that option and remove the check mark.

5. Press the **cancel** key three times to return to measurement mode.

4.4.4 Error output

To select the desired output value that will be sent to the analog output device upon an error, complete the following steps:

1. Press the **enter** key to enter the *main menu*.
2. Press the **▼** key twice and then press the **enter** key to enter the *output menu*.
3. Press the **▼** key three times and then press the **enter** key to enter the *error output menu*.
4. Use the **▲** and **▼** keys to select the desired option and then press the **enter** key to activate that error output. A check mark will appear next to the selected option to indicate that it is activated. The following options are available, and you may activate only one option at a time.

Note: Only the first four options are displayed on the screen upon entering this menu. When you scroll down to the fourth option (NAMUR), a down arrow to the right of this option indicates that an additional screen of options is available.

- None (no error output is generated)
- Low (an output of 4 mA is generated)
- High (an output of 20 mA is generated)
- Value (an error output at a programmable fixed value is generated)
- NAMUR (listed on second screen of options)

Note: Pressing the **enter** key on a different error output will automatically deselect any previously selected output.

5. Press the **cancel** key three times to return to measurement mode.

Chapter 5. The service menu



CAUTION!

The *service menu* is intended for use by qualified service personnel only, and access to this menu requires entry of the service passcode. Misuse of the information in this menu may significantly impair the accuracy and performance of your oxy.IQ and may cause it to fail to meet its published specifications.

5.1 Menu map and service passcode

For help in navigating through the *service menu*, refer to the menu map shown in figure 17. The service passcode required for access to the oxy.IQ service menu is:

7378

5.2 Entering the service menu

To enter the *service menu*, complete the following steps:

1. Press the **enter** key to enter the *main menu*.
2. Press the **▼** key three times and then press the **enter** key to select the *service menu*.
3. Use the **▲** and **▼** keys to increment or decrement the displayed value (default = 5000) to enter the service passcode, and then press the **enter** key to access the *service menu*.

Note: When entering the passcode, press and release an arrow key to change the value one digit at a time, or press and hold an arrow key to change the value at an accelerating rate.

4. Proceed to the appropriate section for the desired menu option.

5.2.1 Diagnostics

To enter the *diagnostics menu* option from the *service menu*, complete the following steps:

1. Use the **▲** and **▼** keys as necessary to highlight the *diagnostics menu* option.
2. Press the **enter** key to enter the *diagnostics menu*.
3. *Page 1* of the *diagnostics option* displays the current values for the following parameters:
 - O₂ μ A
 - Output mA
 - Output %

When you have finished reading the information, press the **enter** key to move to *page 2* of the *diagnostics menu* or press the **cancel** key to exit the *diagnostics menu*.

4. *Page 2* of the *diagnostics option* displays the current values for the following parameters:
 - Temp °C
 - Temp res
 - Gain
 - OX-n (currently installed sensor type, n = 1, 2, 3 or 4)

When you have finished reading the information, press the **enter** key to move to *page 1* of the *diagnostics menu* or press the **cancel** key to exit the *diagnostics menu*.

5. Press the **cancel** key twice to return to measurement mode.

Chapter 6. Specifications

6.1 Intrinsically safe (IS) installation

Intrinsically safe installations require an MTL7706 Zener barrier, one IS cable, and one non-IS cable.

Power requirements

24 to 28 VDC at 50 mA

Cable

P/N 704-1318-02 (2 m length) or *p/n 704-1317-10* (10 m length) blue jacketed, twisted-pair with connector, 26 AWG conductors, with connector

Output

Total load must equal $250 \Omega \pm 5\%$ when using a Zener barrier

6.2 Non-incendive (div 2) and general purpose installation

No Zener barrier or galvanic isolator is used.

Power requirements

9 to 28 VDC, loop-powered, 0.7 W max

Cable

P/N 704-1317-02 (2 m length) or *p/n 704-1317-10* (10 m length) black jacketed, twisted-pair with connector, 26 AWG conductors, with connector

6.3 All installations

Process wetted materials

SS process unit: 316 stainless steel, Viton® o-ring, gold-plated sensor electrical contacts, and glass

User-selectable measurement ranges

- PPM sensors:
 - 0 to 10 ppm_v O₂ (OX-1 or OX-2 only)
 - 0 to 20 ppm_v O₂ (OX-1 or OX-2 only)
 - 0 to 50 ppm_v O₂ (OX-1 or OX-2 only)
 - 0 to 100 ppm_v O₂
 - 0 to 200 ppm_v O₂
 - 0 to 500 ppm_v O₂
 - 0 to 1000 ppm_v O₂
 - 0 to 2000 ppm_v O₂
 - 0 to 5000 ppm_v O₂
 - 0 to 10,000 ppm_v O₂
- Percent sensors:
 - 0% to 1% O₂
 - 0% to 2% O₂
 - 0% to 5% O₂
 - 0% to 10% O₂
 - 0% to 25% O₂
 - 0% to 50% O₂

Accuracy

- ±1% of range at calibration point
- ±2% of range at the calibration point for the 0 to 10 ppm_v O₂ range (OX-1, 2)

Repeatability

- ±1% of range
- ±2% of range for the 0 to 10 ppm_v O₂ range (OX-1, 2)

Resolution

±0.1% of range

Linearity

- ±2% of range (OX-1, 2, 3, 5)
- ±5% of range (OX-4)

O₂ sensor operating temperature

32°F to 113°F (0°C to 45°C)

Sample pressure

Vented to atmosphere during operation and calibration

Atmospheric pressure effect

±0.13% of reading per mmHg (directly proportional to absolute pressure)

Note: During calibration, pressure and flow must be kept constant.

Process connections

1/8" NPT-F inlet and outlet

Dimensions

4.10 x 2.75 x 2.05 in. (104.1 x 69.9 x 52.1 mm)

Weight

1.35 lb (612 grams)

Sample flow rate

1.0 SCFH (500 cc/min) recommended for process units

Electrical classification

Intrinsically safe package with Zener barrier or galvanic isolator:

- USA/Canada:
 - IS for class I, div 1, groups A, B, C, D; T4
 - IS for class I, zone 0, AEx ia IIC T4; Tamb -20 to +60°C
- EU ATEX:
 - II 1 G ia IIC Ga
 - IECEx Ex ia IIC T4; Tamb -20 to +60°C

Intrinsically safe package for non-incendive (div 2) application without use of Zener barrier or galvanic isolator:

- USA/Canada:
 - Class I, div. 2, groups A, B, C, D; T4
- ATEX/IECEx:
 - Ex na IIC T4

European compliance

See the EU declaration of conformity at the back of this manual.

6.4 Product label

A typical product label is shown in figure 8 below:

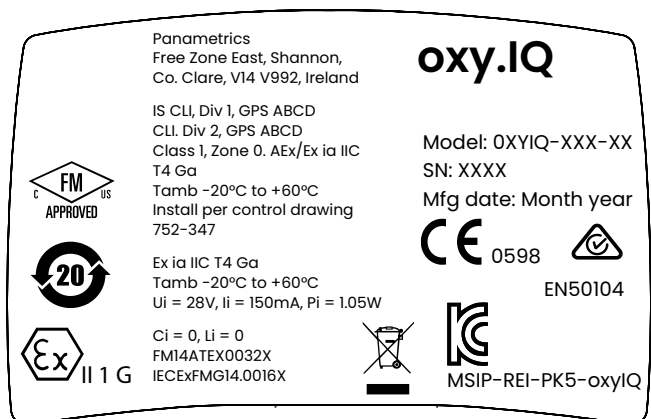

Figure 8: oxy.IQ label - IS package option

Appendix A.

Outline and installation drawings

This appendix includes the following **oxy.IQ** drawings:

- Outline and installation (ref. dwg. 712-1840)
- Cable, standard (ref. dwg. 704-1317, sh 1 of 2)
- Cable, standard (ref. dwg. 704-1317, sh 2 of 2)
- Cable, is (ref. dwg. 704-1318, sh 1 of 2)
- Cable, is (ref. dwg. 704-1318, sh 2 of 2)
- Wiring options (ref. dwgs. 702-285 and 702-286)
- Schematic diagram (ref. dwg. 752-347)

Notes:

1. Weight: 1.35 lb [612.3 g]
2. Color: metallic
3. Dimensions: inches [mm]

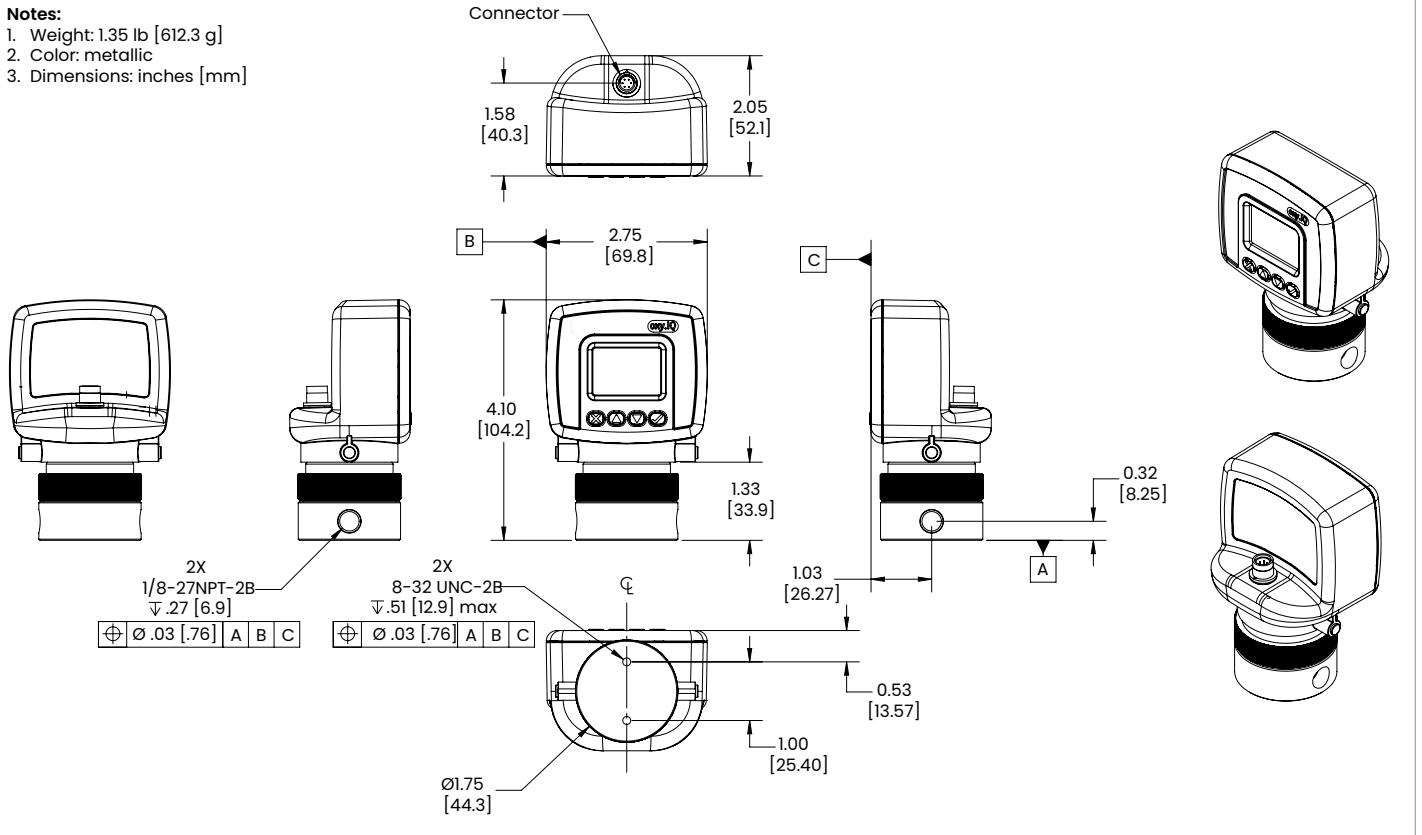

Figure 9: Outline and installation (ref. dwg. 712-1840)

Notes:

1. Interpet drawing in accordance with ASME Y14.5(M)-2009
2. Finished components to be ROHS compliant
3. Part to be clean of dirt/debris
4. Performance specification
Rated current 2.0 A
Rated voltage 24 VDC
Operating temperature range -25 C TO 85 C
Protection class meets NEMA type 1,3,4,6P AND IEC IP67
Retention 6.75 lbs. min. perpendicular & normal
5. Cable assembly shall be tested 100% for continuity and shorts.
Hirose solder & back shell tightening fixture shown on sheet 2.
6. Inspection requirements:
All CTQs (1-11) identified & notes are to be reported on the FAI & meet AQL .65 level II per lot
Specific CTQs identified below are to have a CpK no less than 1.33:
1,2,4,10
Specific CTQs identified below are to have a Cp no less than 1.33:
@LSL - none @USL - none
Attribute data to meet 4 SIGMA (0.63% DPMO) identified below:
None
Cp & CpK, DPMO

Cable length

XX-cable length	Part number extension
2 meters -0/1 (6.56ft -0/+33)	02
10 meters -0/5 (32.81ft -0/+1.58)	10

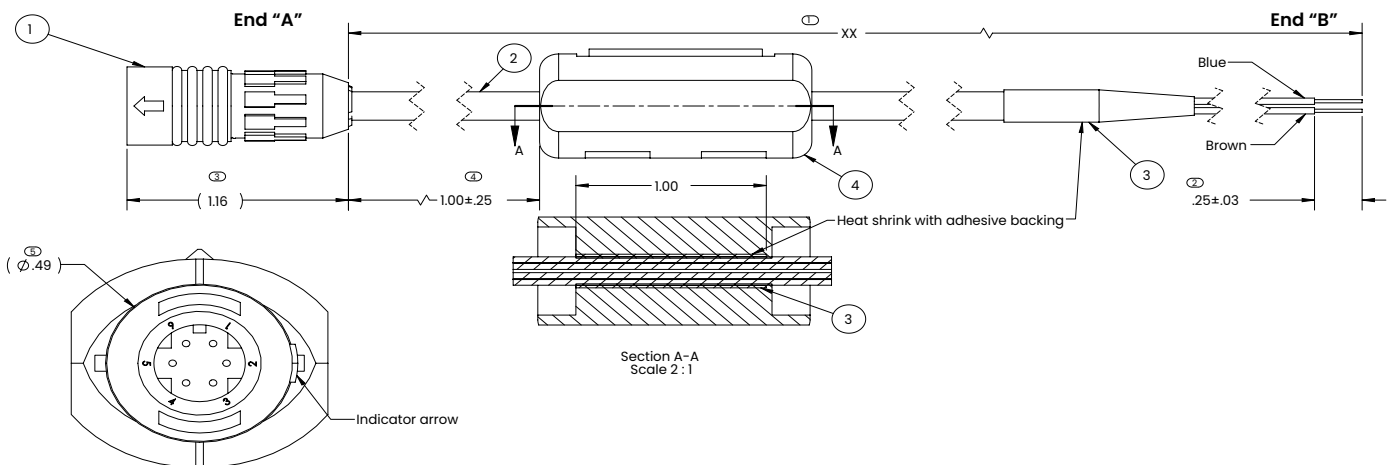

Figure 10: Cable, standard (ref. dwg. 704-1317, SH 1 of 2)

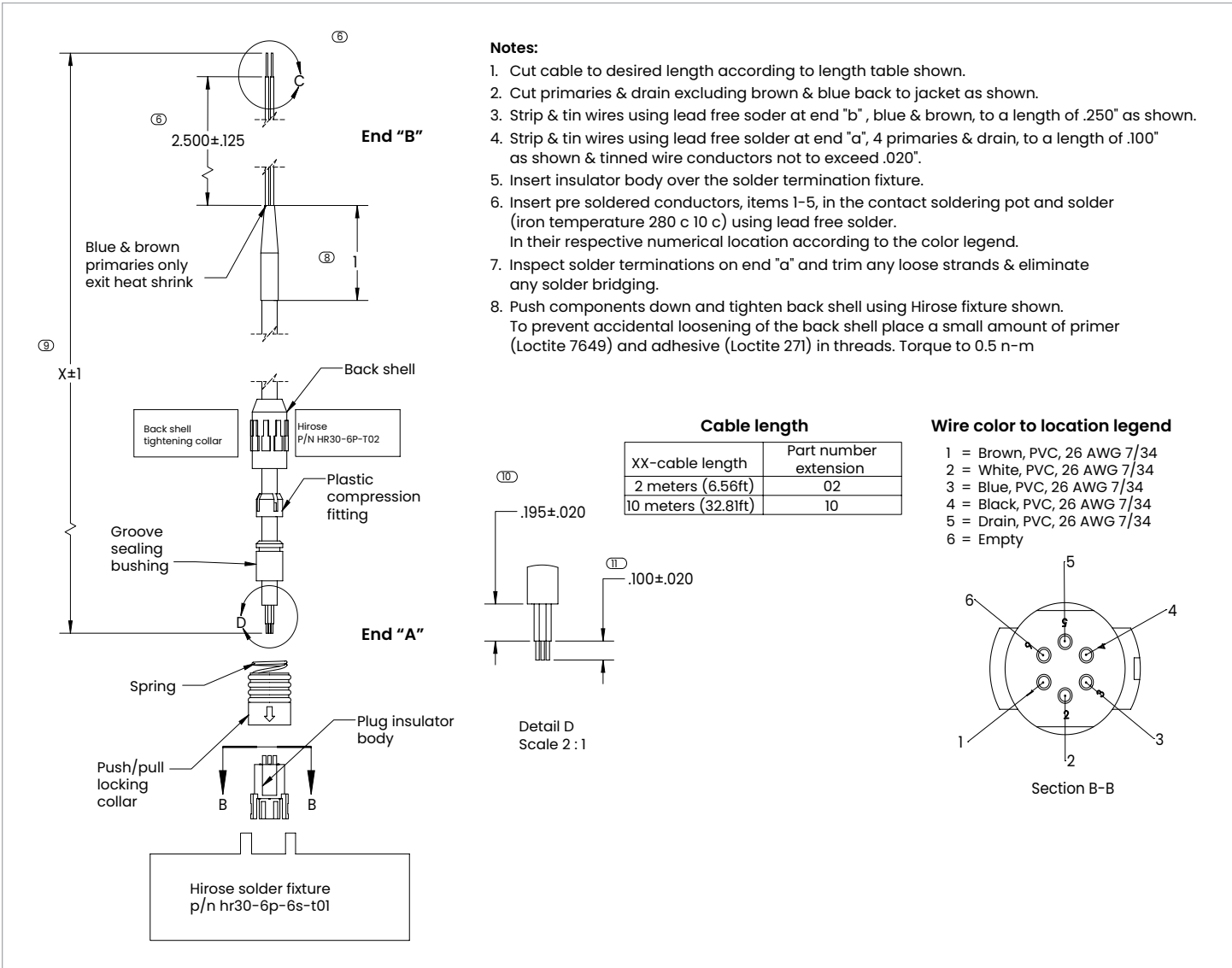

Figure 11: Cable, Standard (ref. dwg. 704-1317, SH 2 of 2)

Notes:

- Interpret drawing in accordance with ASME Y14.5(M)-2009
- Finished components to be ROHS compliant
- Part to be clean of dirt/debris
- Performance specification
 Rated current 2.0 A
 Rated voltage 24 VDC
 Operating temperature range -25 C TO 85 C
 Protection class meets NEMA type 1,3,4,6P and IEC IP67
 Retention 6.75 lbs. min. perpendicular & normal
- Cable assembly shall be tested 100% for continuity and shorts.
 Hirose solder & back shell tightening fixture shown on sheet 2.
- Inspection requirements:
 All CTQs (I-II) identified & notes are to be reported on the FAI & meet AQL .65 level II per lot
 Specific CTQs identified below are to have a Cp no less than 1.33:
 1,2,4
 Specific CTQs identified below are to have a Cp no less than 1.33:
 @LSL none @USL - none
 Attribute data to meet 4 Sigma (0.63% DPMO) identified below:
 None

Cable length

XX-cable length	Part number extension
2 meters -0/.1 (6.56ft -0/+ .33)	02
10 meters -0/.5 (32.81ft -0/+1.58)	10

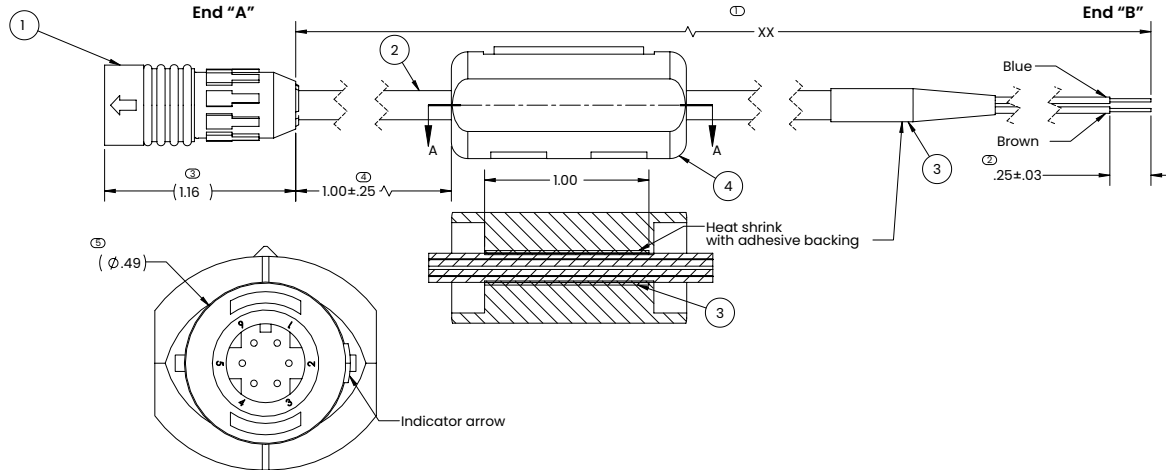
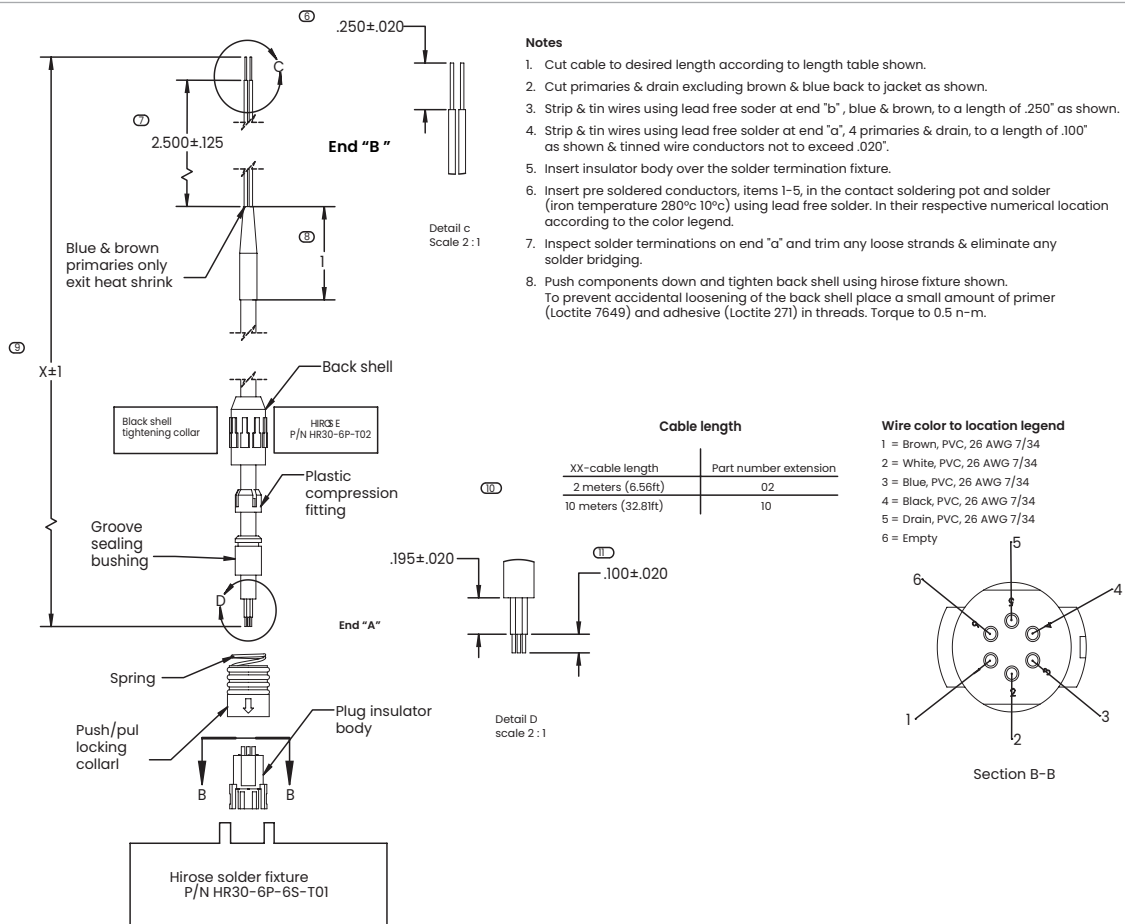

Figure 12: Cable, IS (ref. dwg. 704-1318, SH 1 of 2)



Notes

- Cut cable to desired length according to length table shown.
- Cut primaries & drain excluding brown & blue back to jacket as shown.
- Strip & tin wires using lead free solder at end "b", blue & brown, to a length of .250" as shown.
- Strip & tin wires using lead free solder at end "a", 4 primaries & drain, to a length of .100" as shown & tinned wire conductors not to exceed .020".
- Insert insulator body over the solder termination fixture.
- Insert pre soldered conductors, items 1-5, in the contact soldering pot and solder (iron temperature 280°C 10°C) using lead free solder. In their respective numerical location according to the color legend.
- Inspect solder terminations on end "a" and trim any loose strands & eliminate any solder bridging.
- Push components down and tighten back shell using hirose fixture shown. To prevent accidental loosening of the back shell place a small amount of primer (Loctite 7649) and adhesive (Loctite 271) in threads. Torque to 0.5 n-m.

Cable length

XX-cable length	Part number extension
2 meters (6.56ft)	02
10 meters (32.81ft)	10

Wire color to location legend

- 1 = Brown, PVC, 26 AWG 7/34
- 2 = White, PVC, 26 AWG 7/34
- 3 = Blue, PVC, 26 AWG 7/34
- 4 = Black, PVC, 26 AWG 7/34
- 5 = Drain, PVC, 26 AWG 7/34
- 6 = Empty

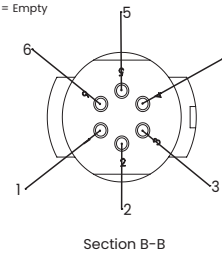
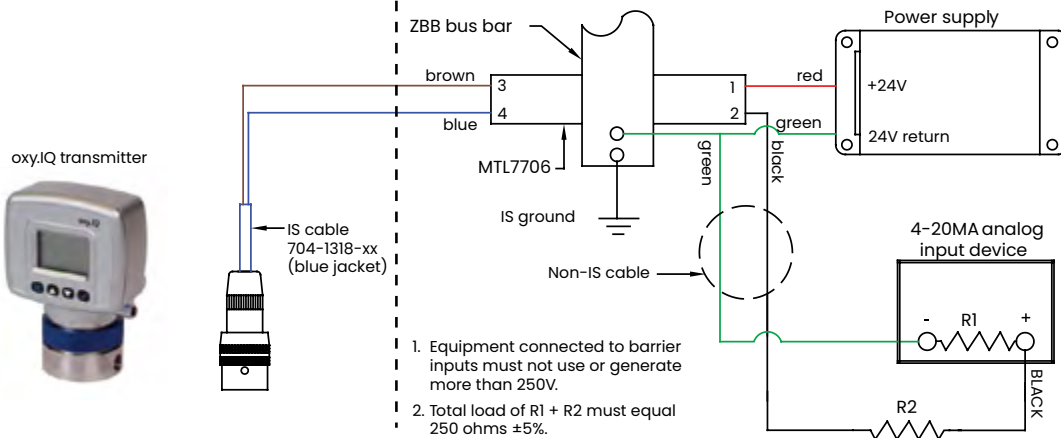

Figure 13: Cable, IS (ref. dwg. 704-1318, SH 2 of 2)

Hazardous location

Non-hazardous location



Hazardous location

Non-hazardous location

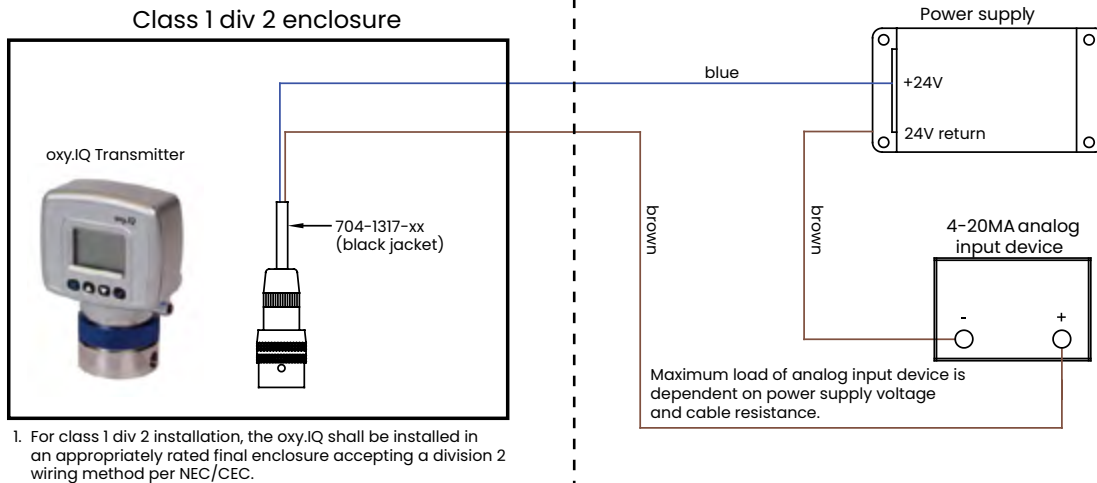

Non-hazardous location

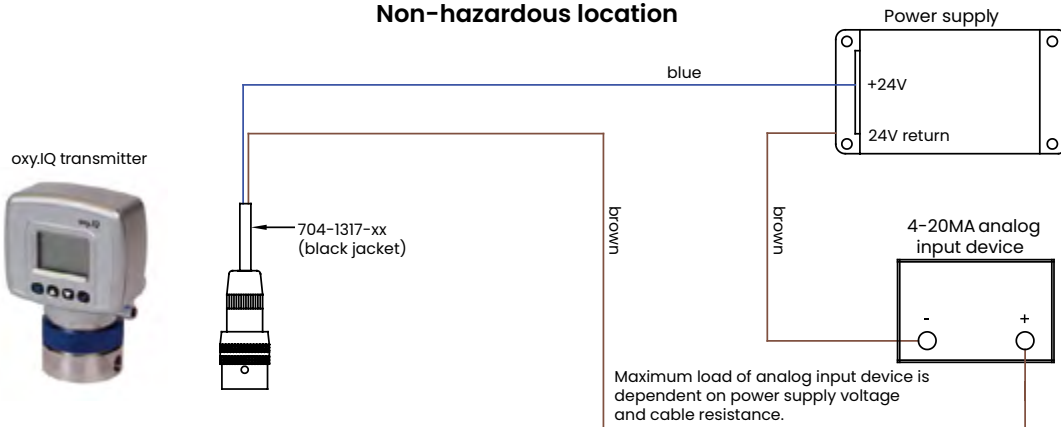

Figure 14: Wiring options (ref. dwgs. 702-285 and 702-286)

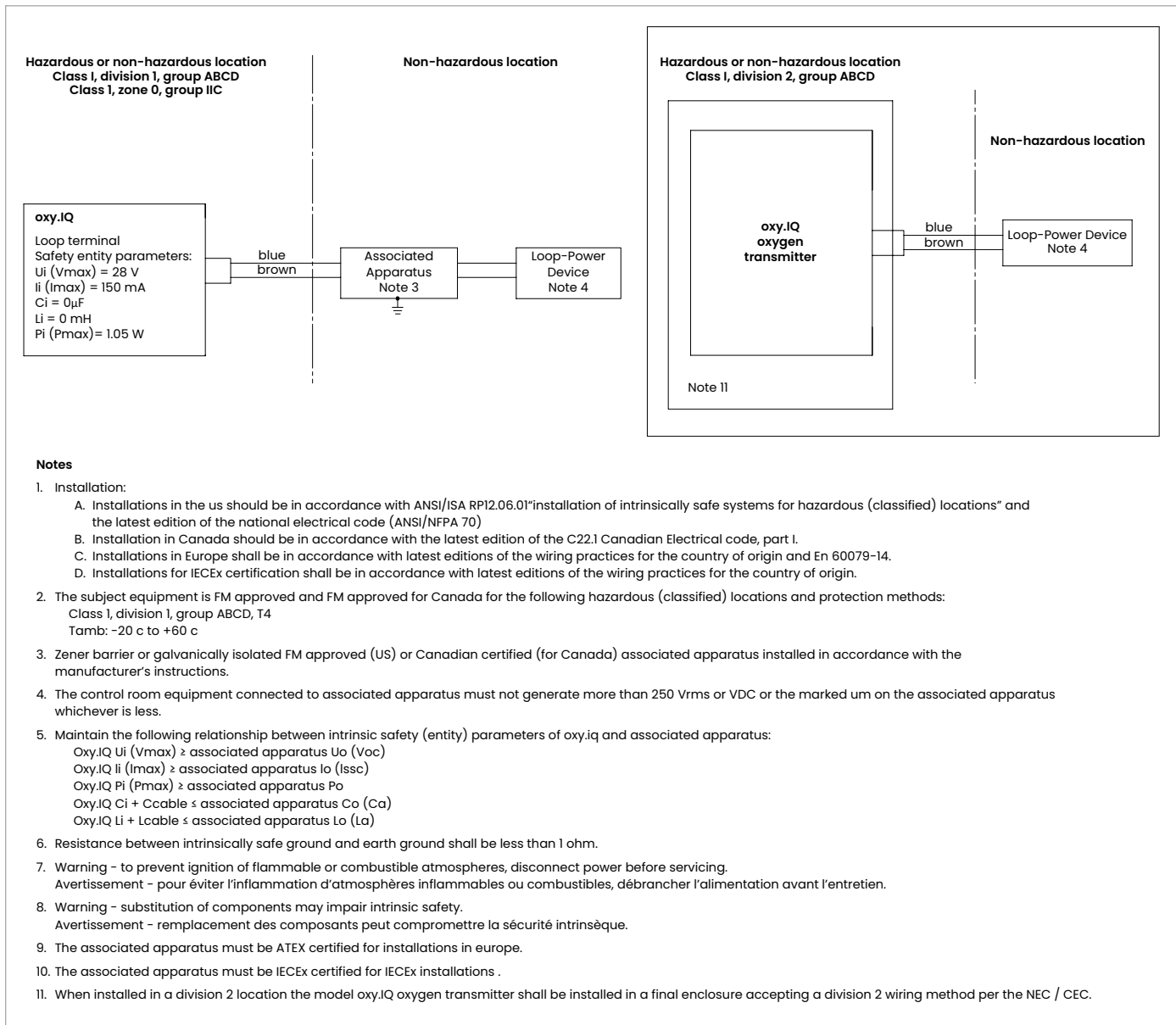
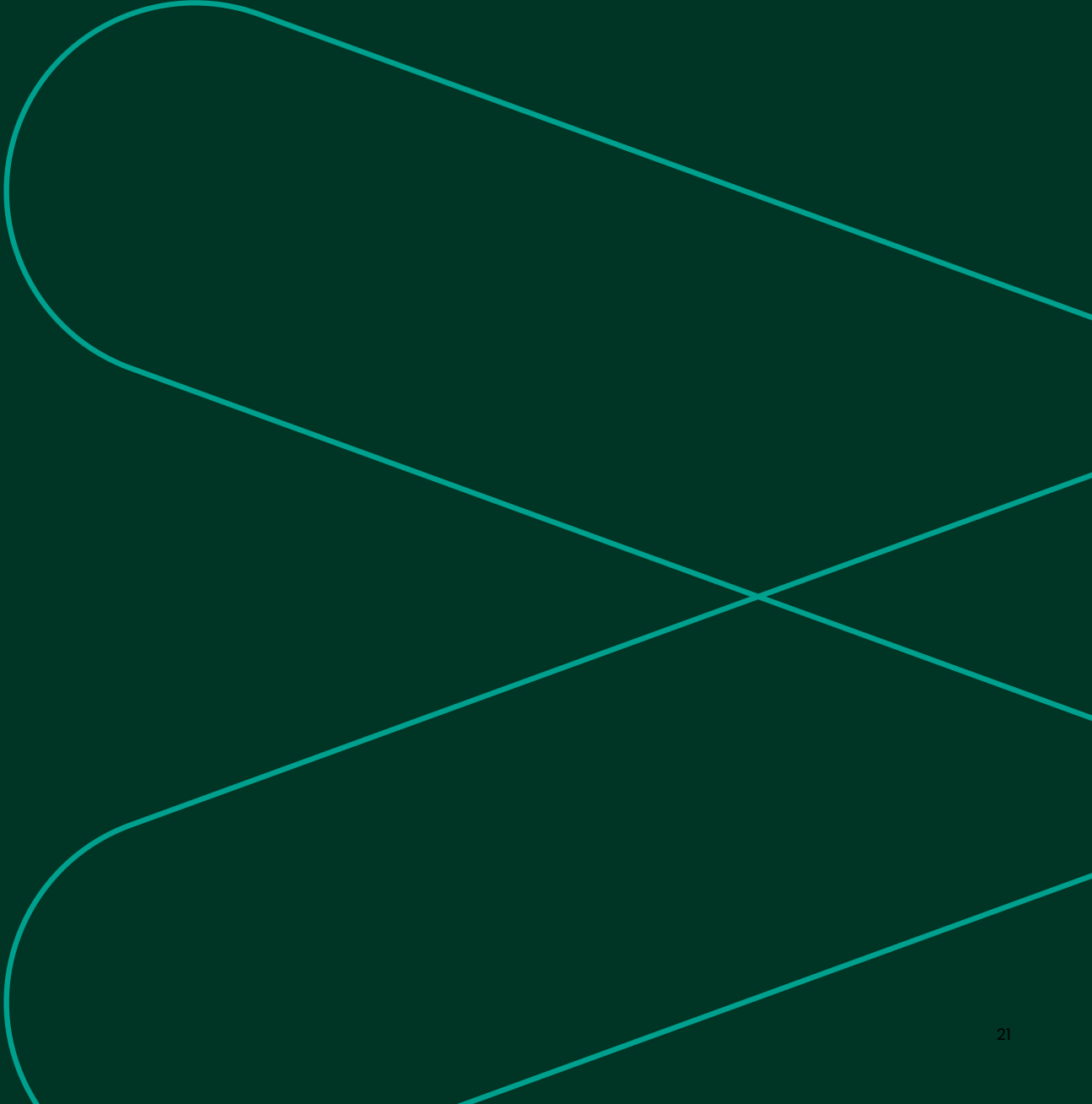

Figure 15: Schematic diagram (ref. dwg. 752-347)

Appendix B. Menu maps

This appendix includes the **oxy.IQ** user menu maps (please note the service menu map is available to qualified Panametrics field service personnel only).



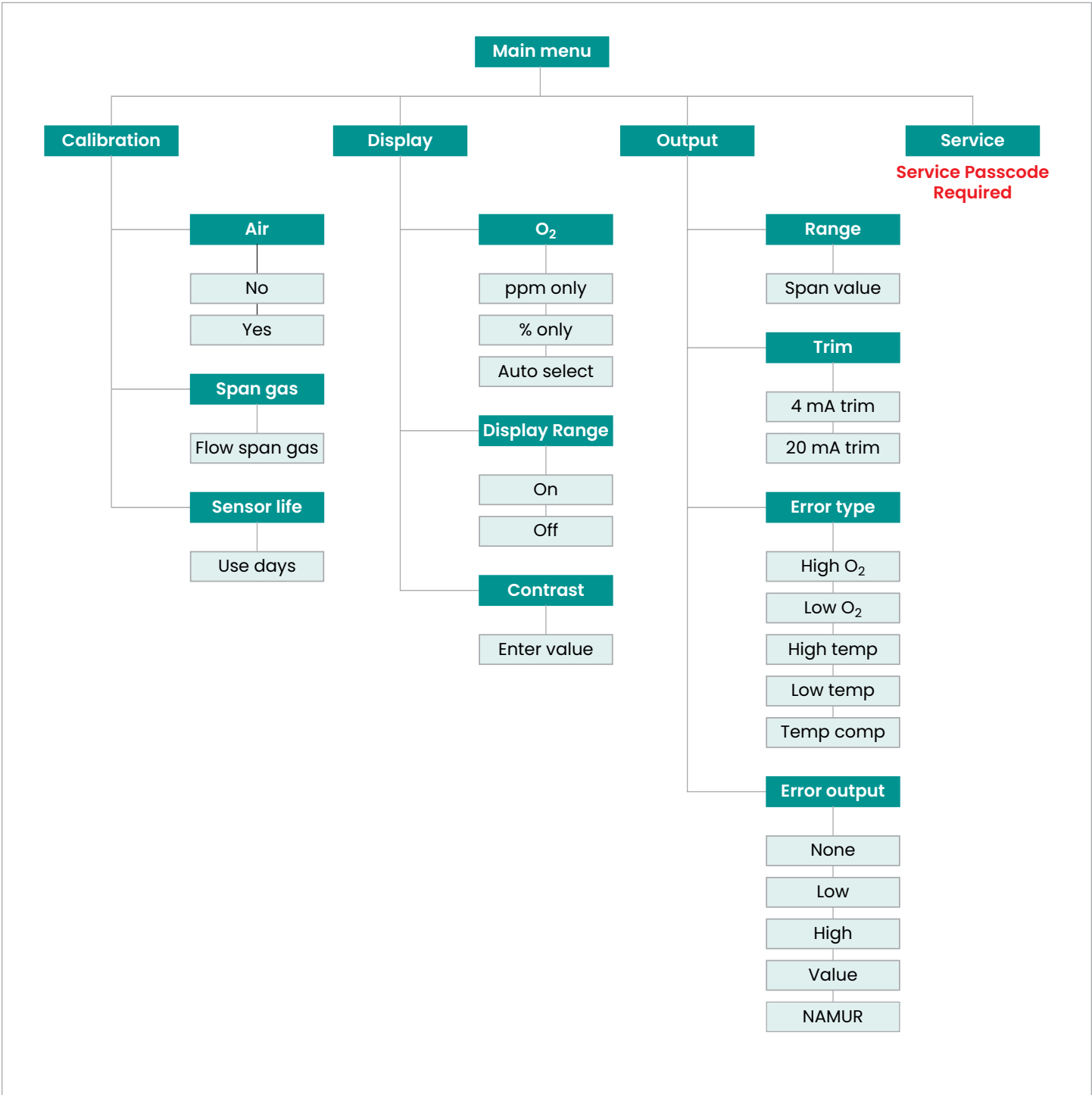

Figure 16: User's menu map

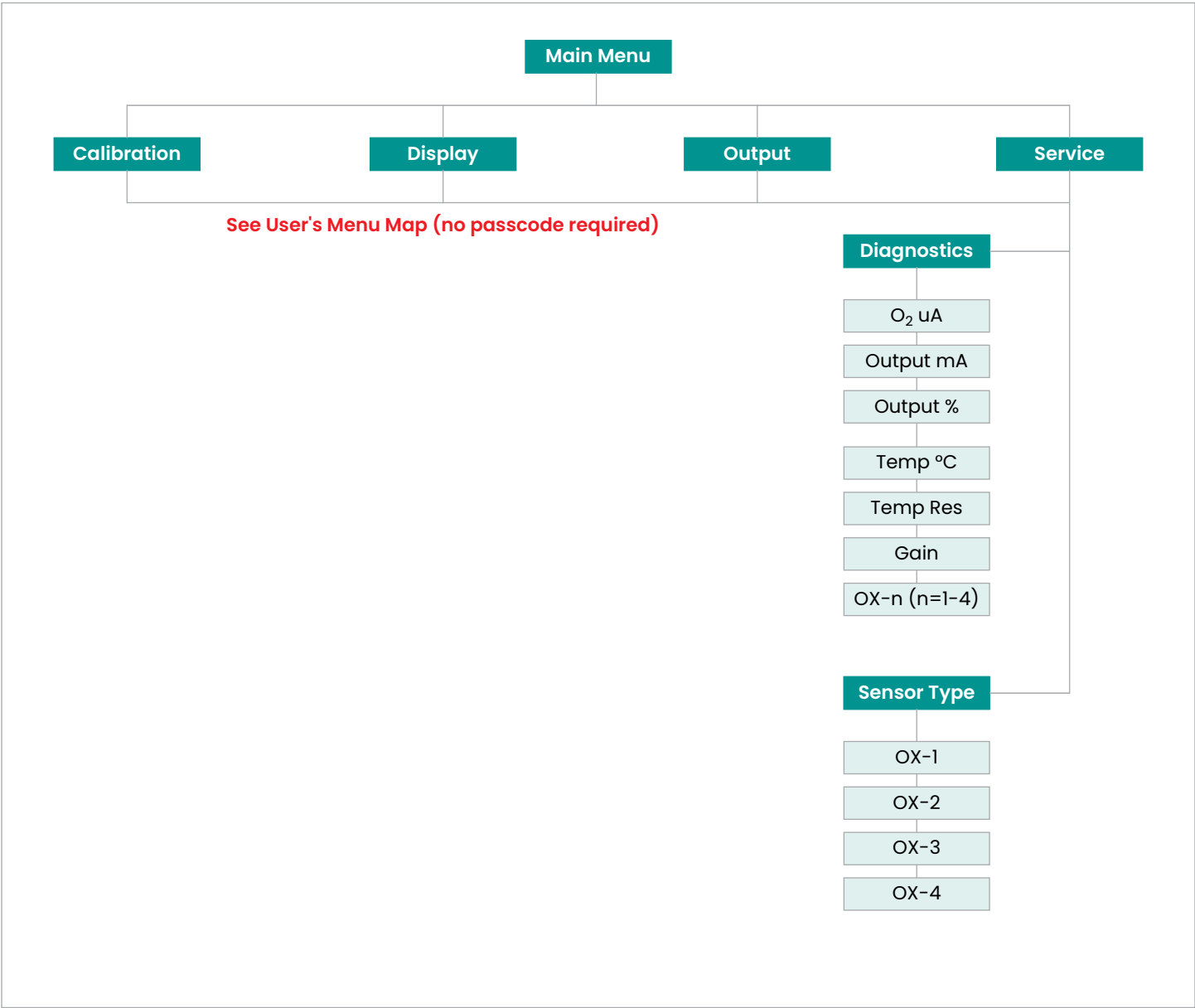

Figure 17: Service menu map

[no content intended for this page]

Appendix C.

Order string

oxy.IQ BCD-E

A Model only

oxy.IQ oxygen transmitter; 4 to 20 mA output

B Sensor

- 0 No sensor
- 1 Standard ppm, 0 to 10, 20, 50, 100, 200, 500, 1000 ppm
- 2 Acid ppm, 0 to 10, 20, 50, 100, 200, 500, 1000 ppm
- 3 Standard percent sensor
- 4 Acid percent sensor
- 5 Standard ppm, 0 to 100, 200, 500 and 1000 ppm

C Package

- 1 Standard package
- 3 Intrinsically safe (US/CAN Class 1 div 1) or Non-incendive (US/CAN class 1 div 2)
- 4 Ex flameproof

D Cable length

- 0 No cable
- 1 2 meter cable
- 2 10 meter cable

E Zener barrier

- 0 None
- 1 Zener barrier
- 2 Galvanic isolator.

Note: For class 1 div 1 either Zener barrier or galvanic isolator must be selected. For class 1 div 2, no barriers needed. Please refer to dwg 752-347 for installation guidelines.

Example part number: oxy.IQ 132-1

Appendix D.

oxy.IQ		Panametrics 1100 Technology Park Drive Billerica, MA 01821				oxy.IQ safety manual	
MODEL		DWG NO.		714-1344	REV. C	TITLE	
Rev	REL/ECO No.	Drawn	Date	Checked	Date	Approved	Date
A	RN 7786	J. Ferro	1/8/15	PMH	1/8/15	J. Ferro	1/8/15
B	ECO-09423	CD SMART	1/19/16	CD SMART	1/19/16	G. KOZINSKI	1/19/16
C	ECO-157348404	CD SMART	1/5/17	J. FERRO	1/5/17	J. FERRO	1/5/17

Certification and safety statements for the oxy.IQ oxygen transmitter

The oxy.IQ is a highly reliable and cost-effective two-wire, loop-powered transmitter with a linearized 4 to 20 mA output. It measures oxygen in ten ppm ranges and seven percentage ranges. All ranges are user-selectable. This compact transmitter uses proven sensor technology to accurately measure O₂ in a variety of gases, even in hazardous environments.

When installing this apparatus, the following requirements must be met:

- The system is covered by the certificate numbers FM14ATEX0032X and IECEx FMG 14.00016X as shown on the labels on the following page. The system temperature code is T4 in the temperature range of -20 to 60 degrees C.
- The apparatus should be de-energized before servicing.
- Installation shall be in accordance with the installation instructions and the National Electrical Code® ANSI/NFPA 70, the Canadian Electrical Code C22.1, or IEC/EN 60079-14, as applicable.
- Equipment is of type Intrinsically Safe and complies with: EN 60079-0:2012, EN 60079-11:2012, IEC 60079-0:2011, IEC 60079-11:2011, IEC 60529:1992, C22.2 No.1010.1:2004, CAN/CSA-E60079-0:2011, CAN/CSA-E60079-11:2011, C22.2.60529:2005, FM Class 3600:2011, FM Class 3610:2010, FM Class 3810:2005, ANSI/ISA 61010-1:2004 Ed.2, ANSI/ISA 60079-0:2009 Ed.5, ANSI/ISA 60079-11:2009 Ed.5
- The product contains no exposed parts which produce surface temperature infrared, electromagnetic ionizing, or non-electrical dangers.
- The product must not be subjected to mechanical or thermal stresses in excess of those permitted in the certification documentation and the instruction manual.

- The product cannot be repaired by the user; it must be replaced by an equivalent certified product. Repairs should only be carried out by the manufacturer or by an approved repairer. Please contact Panametrics Customer Support Center for repair, maintenance or replacement of the product. For oxygen sensor replacements please contact Panametrics Customer Support Center.

U.S.A

Panametrics LLC
1100 Technology Park Drive
Billerica, MA 01821
U.S.A

Tel: 800 833 9438 (toll-free)
978 437 1000

E-mail: Panametricstechsupport@bakerhughes.com

Ireland

Baker Hughes Sensing EMEA
Free Zone East, Shannon,
CO. CLARE, V14 V992, Ireland
Tel: +35 361 470200

- Only trained, competent personnel may install, operate and maintain the equipment.
- For product training please contact Panametrics Customer Support Center:

U.S.A

Panametrics LLC
1100 Technology Park Drive
Billerica, MA 01821
U.S.A



Tel: 800 833 9438 (toll-free)
978 437 1000

E-mail: Panametricstechsupport@bakerhughes.com

Ireland

Baker Hughes Sensing EMEA
Free Zone East, Shannon,
CO. CLARE, V14 V992, Ireland
Tel: +35 361 470200

- The product is an electrical apparatus and must be installed in the hazardous area in accordance with the requirements of the EC Type Examination Certificate. The installation must be carried out in accordance with all the appropriate international, national and local standard codes and practices and site regulations for Intrinsically Safe apparatus and in accordance with the instructions contained in the manual. Access to the circuitry must not be made during operation.
- The maximum operating pressure for the oxy.IQ is 10psi. Be sure the sample conditioning system is designed to maintain the oxy.IQ pressure below these limits, and that the oxy.IQ outlet is vented to atmosphere during operation and calibration.

	WARNING! Substitution of components may impair intrinsic safety.
	WARNING! To prevent ignition of flammable or combustible atmospheres, disconnect power before servicing.
	AVERTISSEMENT Pour éviter l'inflammation d'atmosphères inflammables ou combustibles, débrancher l'alimentation avant l'entretien.
	AVERTISSEMENT Remplacement des composants peut compromettre la sécurité intrinsèque.

- Equipment is not intended for the measurement of oxygen in fluid of liquid phase

Special conditions of safe use

- The model oxy.IQ will not pass the 500V dielectric test. This must be taken into account upon installation.

Markings

Markings shall appear on the oxy.IQ as shown below for the ontrinsically safe version of the product.

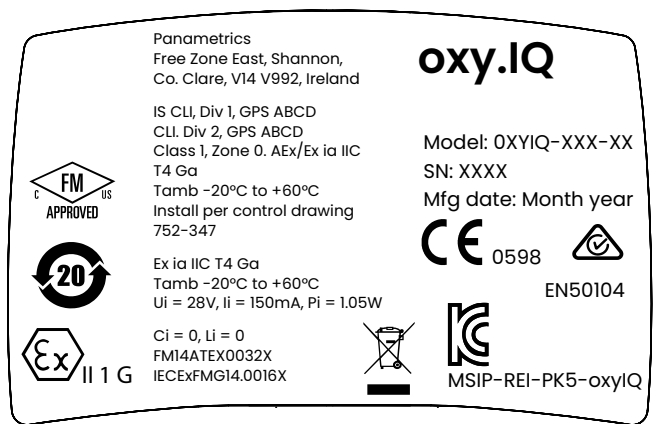

Connection and wiring diagram

The following diagram is the entity parameters for the oxy.IQ.

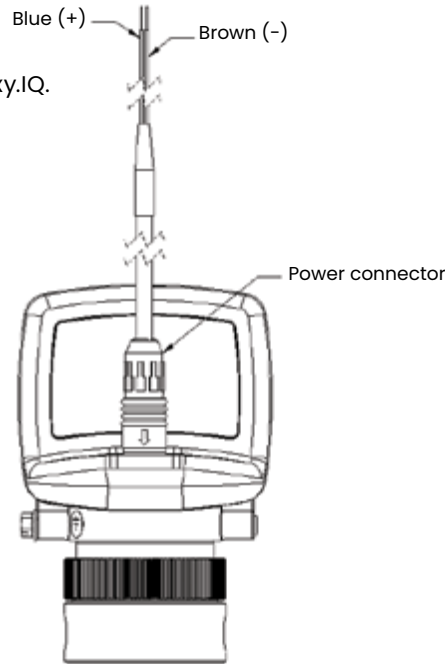

Power requirements:

Nominal operating parameters: 28VDC at 50mA

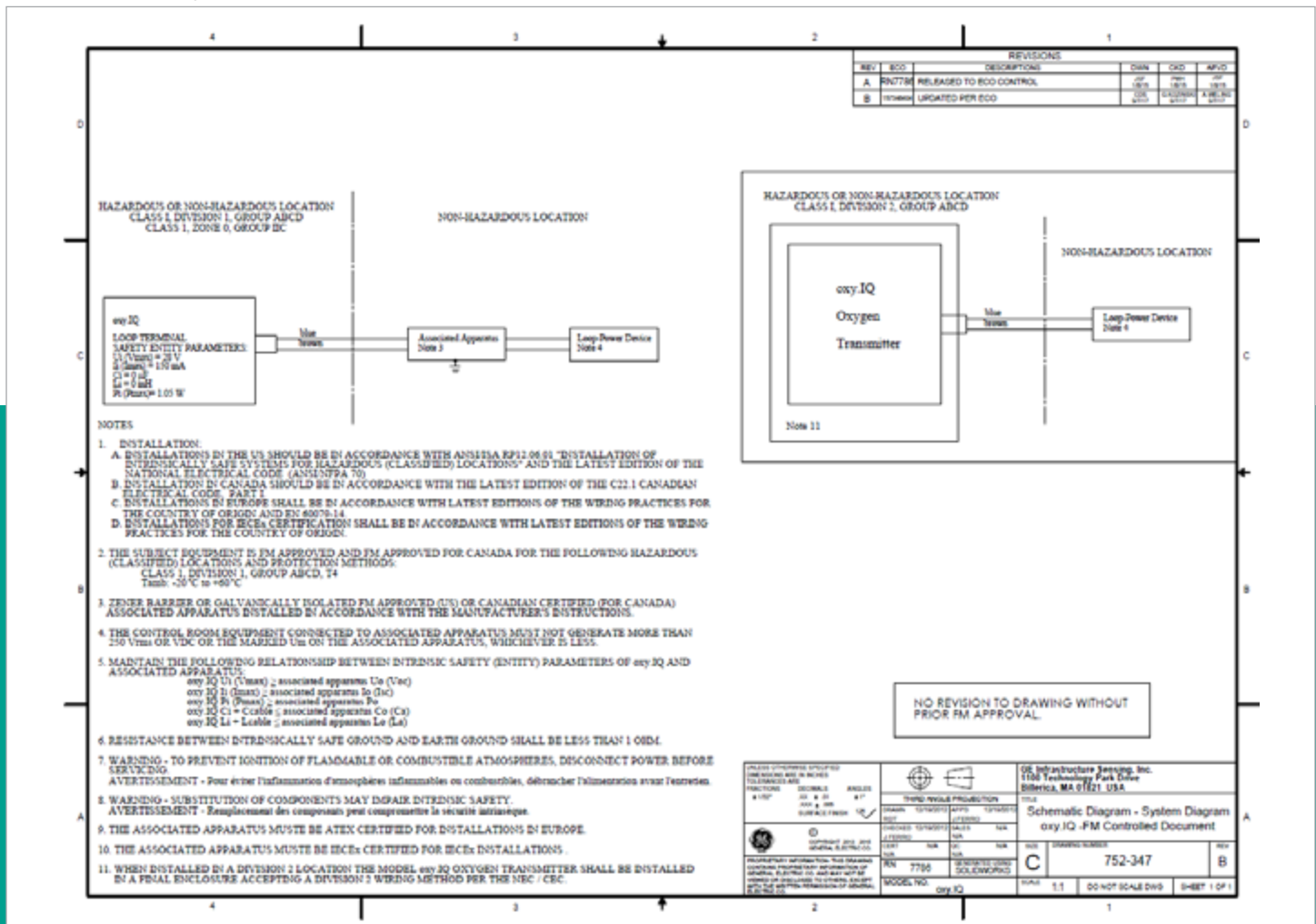

We,

**Panametrics
1100 Technology Park Drive
Billerica, MA 01821
USA**

declare under our sole responsibility that the

oxy.IQ™ Oxygen Transmitter

to which this declaration relates, is in conformity with the following standards:

- EN 60079-0:2012+A11:2013
- EN 60079-11:2012, II 1 G – Ex ia IIC T4 Ga
QAN license 0795 : SGS Baseefa Ltd, Buxton SK17 9RZ, UK - NoBo# 1180
- EN 61326-1: 2013, Group 1, Class A, Industrial EM Environments
- EN 61326-2-3: 2013

following the provisions of directives 2014/30/EU (EMC) and 2014/34/EU (ATEX).

EU Type Examination Certificate:

- FM14ATEX0032X
FM Approvals Ltd, Windsor SL4 1RS, UK - NoBo# 1725

The product listed above, and any ancillary equipment supplied with it, does not bear the CE mark for directive 2014/68/EU (Pressure Equipment) as it falls under Article 4, section 3 (sound engineering practice) for DN <25.

Directive 2014/35/EU is not applicable due to the 28 V d.c. maximum operation voltage.

Billerica - October 25, 2016



Mr. Chris Frail
Engineering Manager

A		I	
Adjusting, oxy.IQ	7	Initial setup	13
Air calibration	8	Installation	
Analog output		Cable	8
see Output		Drawings	37
Applications	2	Mounting the oxy.IQ	5
		Oxygen sensor	10
B		Sensor manifold	6
Buttons, Keypad	13	Wiring	8
		Interference gases	4
C		Intrinsically safe	2
Cable			
Connector	8	K	
Installed	8	Keypad, Buttons	13
Longer	9		
Calculating Analog output	19	L	
Calibration		Label, product	35
Air	17		
Existing oxygen sensor	18	M	
Menu	21	Main menu	
New oxygen sensor	18	Entering	14
oxy.IQ	14	Map	46
Span gas	19	Menu	
Certifications	51	Calibration	21
Contrast, Adjusting Display	24	Display	21, 23
		Output	15, 21, 25
D		Service	14
Diagnostics menu	30	Trim	16
Dimensions	33	User	14, 21
Display		Menu maps	45
Contrast, Adjusting	24	Main menu, service	47
Location	13	Main menu, user's	46
Menu	21, 23	Mounting the oxy.IQ	5
O ₂ parameter, selecting	23		
Range, setting	24		
Document number	i		
Drawings, outline and Installation	37		
E			
Error			
Output value	27		
Type, selecting	25		
F			
Features	3		

O	
O ₂ Display parameter, selecting	
Order string	
O-ring, sensor manifold	
Outline and Installation Drawings	
Output	
Calculation	
Error condition	
Error value	
High (20 mA), trimming	
Low (4 mA), trimming	
Menu.....	
Range, selecting	
Trimming.....	
oxy.IQ	
Adjusting.....	
Calibrating.....	
Calibration, Air	
Calibration, span gas.....	
Installing	
Output range, selecting	
Oxygen sensor	
Calibration, Existing.....	
Calibration, new	
Installation.....	
Sensor Life	
Unpacking	
P	
Passcode, service menu.....	
Pressure rating.....	
Programming, user	
Publication Date	
R	
Range	
Selecting.....	
Setting Display.....	
Registration.....	
Regulatory compliance.....	
RoHS compliance	

S	
Safety	
Auxiliary Equipment.....	
General Issues	
Personal Equipment	
Sample system	
Sensor manifold	
Mounting.....	
O-ring.....	
Service menu	
Diagnostics option.....	
Entering	
Menu map	
Passcode	
Services.....	
Span gas calibration	
Specifications.....	
Support	
Customer support centers.....	
T	
Terms and conditions.....	
Trimming	
Analog output	
Output, High (20 mA)	
Output, low (4 mA).....	
Typographical conventions.....	
W	
Warranty.....	
WEEE compliance.....	
Weight	
Wiring the oxy.IQ	

Customer support centers

Americas

U.S.A.

The Boston Center
1100 Technology Park Drive
Billerica, MA 01821

U.S.A.

Tel: +1 800 833 9438 (toll-free)

Tel: +1 978 437 1000

E-mail: Panametricstechsupport@
bakerhughes.com

Europe

Ireland

Sensing House
Shannon Free Zone East
Shannon, County Clare
Ireland

Tel: +353 61 61470200

E-mail: Panametricstechsupport@
bakerhughes.com

Panametrics, a Baker Hughes Business, provides solutions in the toughest applications and environments for moisture, oxygen, liquid and gas flow measurement. Experts in flare management, Panametrics technology also reduces flare emissions and optimizes performance.

With a reach that extends across the globe, Panametrics' critical measurement solutions and flare emissions management are enabling customers to drive efficiency and achieve carbon reduction targets across critical industries including: Oil & Gas; Energy; Healthcare; Water and Wastewater; Chemical Processing; Food & Beverage and many others.

Join the conversation and follow us on LinkedIn
[linkedin.com/company/panametricscompany](https://www.linkedin.com/company/panametricscompany)

Copyright 2021 Baker Hughes Company. All rights reserved.

910-296E
BHCS38977

(06/2021)

Baker Hughes 

panametrics.com